

**Independent
guide to the
BBC MICRO!**

THE MICRO USER

Volume 2
Number 8
October 1984
£1.25

**Bring split-screen
power to your micro**

**Two great games:
Hunt the Wampus
Escape the Goulogs**

**6809 2nd processor,
Addcom reviewed**

**How to conjure up
extra colours ...
write your own
ROM software**

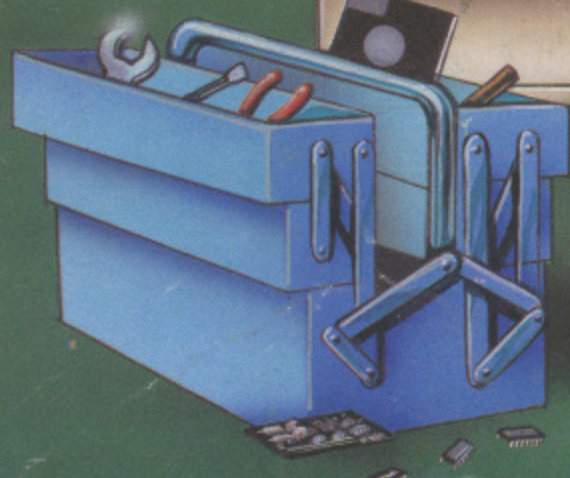

**Seven
Toolkit
ROMs
compared**

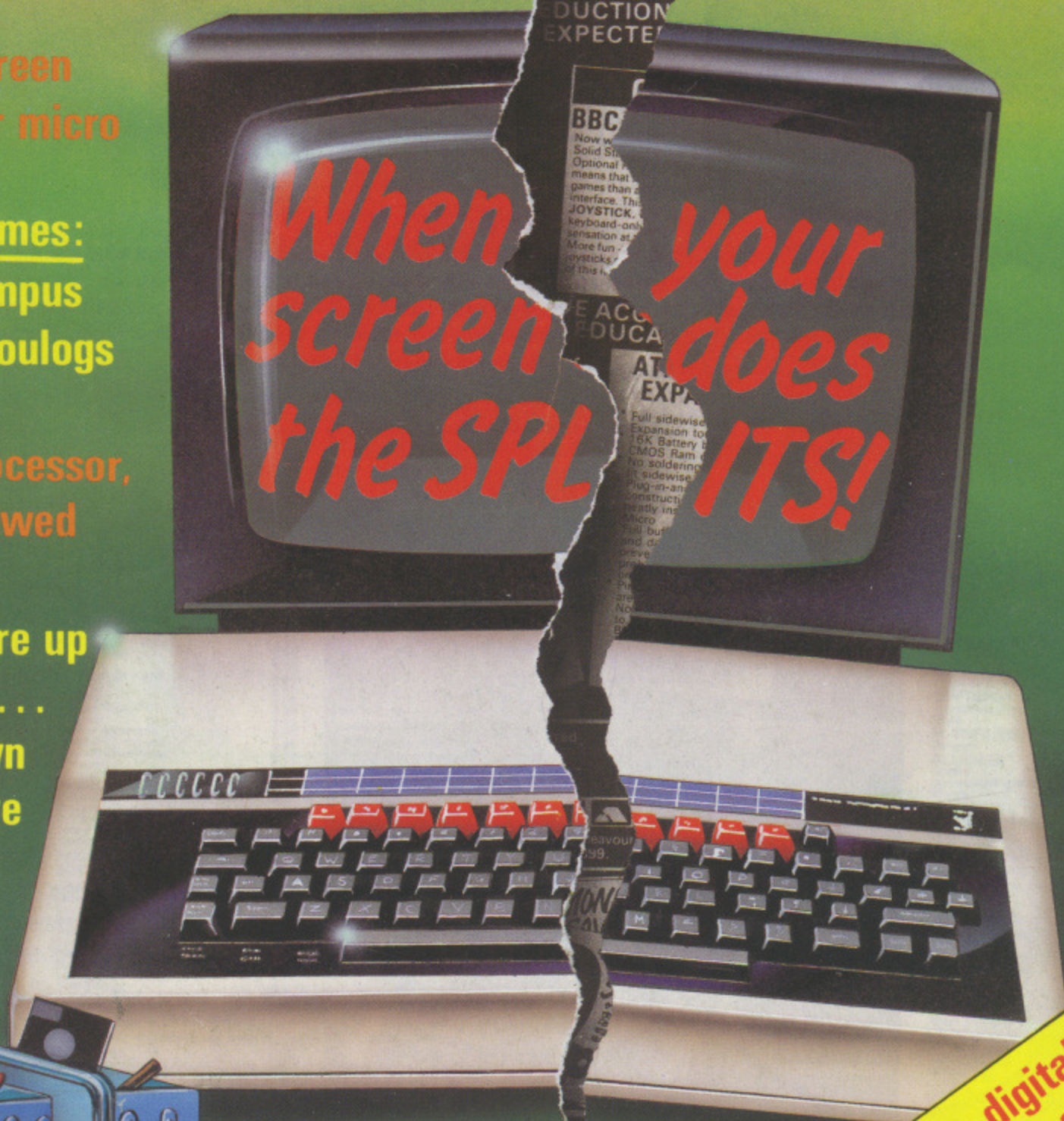

**When
screen
the SPL
your
does
ITS!**

**Win a ROM
box in our
free contest**



— Page 97

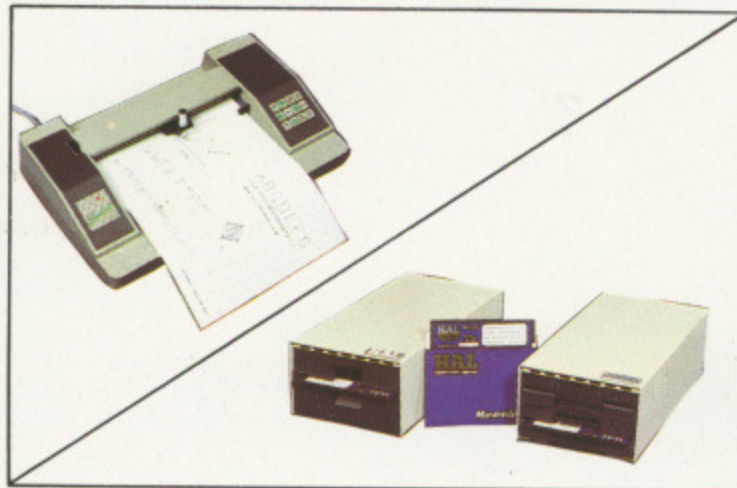

**Build your own digital
to analogue converter
— Page 199**

A Free Training Course with Every Plotter or Disc Drive



Our Sweet-P, high resolution graphics plotters come with free computer based demonstration and instruction programmes which not only show you what the plotter can do, but teaches you how it does it. Our high quality floppy disc drives are supplied with a utilities disc that includes not only the usual file handling and operating software, but a teaching programme for each utility as well. HAL makes it easy for you to upgrade and teaches you how to get the best from your system.

Plus a full line of BBC compatible products

100 CPS Matrix Printers HIGH QUALITY	Nashua Floppy Discs	Monitors- Monochrome
		
LOW LOW PRICE	Price per 10	£99
	Reference Description	
	MD1 SSSD	21.30
	MD1D SSDD	22.75
	MD-2D DSDD	26.95
	MD-1F SSDD ^{96 TP1}	30.05
	MD-2F DSDD ^{96 TP1}	31.25



HAL Computers Limited,
Invincible Road, Farnborough,
Hants. GU14 7QU
Telephone: (0252) 517171

To HAL Computers, Invincible Road, Farnborough, Hants. GU14 7QU
Please send me:

Quantity		Delivery & VAT	Total
	Sweet-P Plotters plus support pack & software at	£575.00	£671.00
	*200K double-sided disc drives at	£216.00	£258.20
	KDC FT 5001 Matrix printers at	£249.00	£296.15
	TECO Monochrome monitors at	£99.00	£123.65
	Nashua model diskettes at £..... per box of 10 + 60p per box postage & VAT		

Free details on HAL's BBC Micro compatible products plus a commemorative Schneider Trophy winner's poster. Please Tick *Other capacities also available
I enclose a cheque for £ _____ or debit my Access Account No: _____

Name _____ Address _____
Tel. _____ Signature. _____

Computerama

the source

ROM SOFTWARE	INC VAT
Wordwise	39.95
View	59.00
Printmaster	32.95
Caretaker	32.95
Disc Doctor	32.95
Termi (terminal emulator)	32.95
Graphics Extension	32.95
DFS: The Upgrade	27.95
Acorn Speech System Upgrade	55.00
HCCS Forth	39.95
HCCS Logo Forth	67.85
HCCS Pascal	57.00
HCCS Excel	74.75
ROM Expansion Board (ATPL) The Best!	43.70

Starbase	69.00
Multiforth/83	51.75
Delux Version (inc. Disc)	92.00
Toolkit	27.00
Toolstar	32.95
Commstar	32.95

BOOKS	NO VAT
BBC Micro Disc Companion	7.95
Creative Graphics	7.50
Graphs & Charts	7.50
Lisp Manual	7.50
Forth Manual	7.50
BCPL Manual	15.00

Discovering BBC Micro Machine Code	6.95
BBC Micro Disk Manual	1.95
Disk Systems For The BBC Micro	6.95

MICRO POWER	INC VAT
Killer Gorilla	7.95
Cybertron Mission	7.95
Cosmic Combat	7.95
Chess B	7.95
Danger UXB	7.95
Escape Moonbase Alpha	7.95
Felix in Factory	7.95
Felix & Fruit Monsters	7.95
Nemesis	7.95
Bumble Bee	7.95
Wizards Challenge	7.95
Jet Power Jack	7.95
Positron	7.95
Demon Decorator	6.85
Alien Swirl	7.95
Alien Destroyers	7.95
Space Jailer	7.95
Ghoulis	7.95
Moon Raider	7.95
The Mine	7.95
Hell Driver	7.95
Labyrinths of LaCoshe	7.95

Zam	7.95
Blockbuster	7.95
Rubble Trouble	7.95
Frenzy	7.95
Stock Car	7.95
Dune Ritzler	7.95

SUPERIOR SOFTWARE	INC VAT
Hunchback	7.95
Overdrive	7.95
Battletank	7.95
Cosmic Kidnap	7.95
Star Battle	7.95
Moon Mission	7.95
Percy Penguin	7.95
Boris In The Underworld	7.95
Rocky	7.95
Spitfire Command	7.95
Crazy Painter	7.95
Road Racer	7.95
Mr Whizz	7.95
Wallaby	7.95
Smash and Grab	7.95
Starstriker	7.95

BUG-BYTE	INC VAT
Twin Kingdom Valley	9.95

DYNABYTE	INC VAT
Pool	7.95
Horserace	7.95
Lemming Syndrome	7.95
Corporate Climber	7.95

BBC/ACORN/SMART	INC VAT
Algebraic Manipulation	9.95
Business Games	9.95
Castle of Riddles	9.95
Creative Graphics	9.95
Countdown to Doom	9.95
Forth	16.95
Graphs & Charts	9.95
Hopper	9.95
Lisp	16.85
BCPL (Rom + Disc)	99.95
Missile Base	9.95
Meteors	9.95
Kingdom Of Hamil	9.95
Monsters	9.95
Planetoid	9.95
Rocket Raid	9.95
Snooker	9.95
Sphinx Adventure	9.95
Starship Command	9.95
Tree of Knowledge	9.95
Snapper	9.95
Shirley Conran's Magic Garden	9.95
Personal Money Management	9.95
Draughts and Revers	9.95
Aviator C/D	14.95/17.25
J.C.B. Digger	9.95
Free Fall	9.95
Carousell	9.95
Drogna	9.95
Volcano	9.95
Tetrapod	9.95
S. Pascal	19.50

ACORN/SMART EDUCATIONAL SOFTWARE NOW AVAILABLE	
White Knight II	11.50
Vutype	16.10
Tax Calc	17.25
Beyond Basic	11.50
Toolbox	21.00
Canyon	10.00
Record Keeper	15.00

ACORN/SMART MIRLE NOW IN STOCK	P.O.A.
IMAGINE	INC VAT
Pedro	5.50
Cosmic Cruiser	5.50
B.C. Bill	5.50

SOFTWARE INVASION	INC VAT
Eagles Wing	7.95
Spooks and Spiders	7.95
3-D Bonib Alley	7.95
Gunsmoke	7.95
Vortex	7.95
Attack on Alpha Centauri	7.95

COMPUTERAMA SOLID STATE JOYSTICK INTERFACE

* with RAPID-FIRE feature
Now a totally new concept in joystick control for your BBC Micro. Simply plug into the analogue port, and connect ANY Atari type joystick for instant joystick control. FREE keyboard conversion programme allows joystick control of keyboard-only games. No memory-conflicts with this one - due to our unique Relocatable Code feature. ORDER TODAY. Only a few available. Demand is bound to be high.

£14.95 + 50p Carriage

TORCH Z80 DISC PACK WITH OVER £1,100 OF SOFTWARE FREE



ORDER TODAY. Get the Z80 version of BBC Basic FREE (Worth £125) runs BBC Micro programmes up to 10 tracks on fast 32K for graphics and 48K for Basic programme.

£189 ONLY
INC. VAT Free Carriage UK only.

Software includes:
● PERFECT WRITER ● PERFECT SPELLER ● PERFECT CALC ● PERFECT FILER ● TORCH NET
The TORCH Z80 DISC PACK is the most powerful BBC Micro disc upgrade available. It provides 800K of storage plus a Z80 Second Processor running Torch's own CP/M compatible operating system. Clip this ad to your order to receive free 40 80T converter programme.

● NEW TORCH Z80 PACK. Add Torch Power to any 80 track drive. Complete 2nd Processor AND Free Perfect software worth £1100 ONLY.
£343 INC. VAT



JUKI 6100 DAISYWHEEL PRINTER
SAVE OVER **£130**

FREE 10 Ribbons
FREE Printer Cable
FREE Paper

These items Alone could cost over £80 Elsewhere.
COMPLETE PACKAGE
Worth £535

COMPUTERAMA PRICE ONLY **£399**

MAIL ORDER No Stamp Required

Post your order today to

COMPUTERAMA

DEPT BBC 10 FREEPOST

STAFFORD ST16 2BR

OR TELEPHONE OUR MAIL

ORDER HOT LINE With your

ACCESS or VISA number we will endeavour

to dispatch immediately. (0785) 41899.

EPSON FX80

A SUPERB PRINTER AT A SUPERB PRICE



This most popular of HIGH PERFORMANCE dot matrix printers has all the features you could ask for:

- 160 cps 11 - 9 matrix proportional spacing
- Normal Elite & Italic Characters
- Fractor & Friction Feed 10 Carriage
- Bi-directional Logic Seeking
- Centronics Interface Standard
- Down loadable Character Set
- User Defined
- Condensed & Double Width Printing
- Super & Subscripts
- Dot Addressable Graphics

NOW AT THE AMAZING PRICE OF **£389** INC. VAT

RING FOR LATEST PRICES. MANY REDUCTIONS EXPECTED

QUICKSHOT II BBC MICRO JOYSTICK

Now with rapid fire Option and Solid State interface. Optional Relocatable code feature - means that it WORKS with more games than any other similar interface. This SELF-CENTERING JOYSTICK, works even with keyboard-only programmes. A sensation at the Micro User Show. More fun - reaches the games other joysticks cannot. Limited supplies of this item.



£19.95 + £1.55 p&p

WE ACCEPT INSTITUTIONAL EDUCATIONAL ORDERS

ATPL SIDEWISE ROM EXPANSION BOARD

- Full sideways Rom Expansion to 16 Roms
- 16K Battery backed CMOS Ram option
- No soldering required to fit sideways
- Plug-in-and-go construction - Mounts neatly inside the BBC Micro
- Full buffering of address and data busses - prevents data bus loading problems associated with unbuffered boards
- Pin 1 of on-board sockets are connected properly - No spurious crashes due to this known fault on BBC Micro. Existing sockets on BBC Micro are usable. All Epmom sockets are accessible without removing sideways.

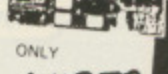

ONLY **£43.70** + £1.00 carriage

24 HOUR DESPATCH ON STOCK ITEMS

HARDWARE CORNER

BBC	INC VAT
Acorn Electron	189.00
+ 1 Electron Interface	59.95
BBC Model B	399.00
BBC Model + DOS	469.00
BBC Micro Disc Upgrade	P.O.A.
BBC Micro A-B Full Upgrade	95.00
BBC Micro Teletext Receive	225.00
BBC Micro Z80 2nd Processor	299.00
BBC Micro 6502 2nd Processor	199.00
Torch Graduate	P.O.A.
Torch Unicorn	P.O.A.

DISC DRIVES	INC VAT
LVL Dual 100K	340.00
Pace Single 100K	169.95
Pace Single 40/80T D/Sided	282.90
Pace Dual 100K	338.00
Pace Dual 40/80T D/Sided	573.95
Torch Dual 400K Z80 Disc Pack	799.00
Pace 200K 40T D/Sided	243.00
HOBBIT FLOPPY DRIVES	99.95
Torch Dual 400K Z80 Disc Pack	789.00

PRINTERS	INC VAT
Epson FX80	269.00
Epson RX80FT	299.00
Epson FX80	389.00
Epson FX100	569.00
Shinwa CP80	229.00
Riteman	286.00
Juki 6100 Daisywheel	399.00

MONITORS	INC VAT
Microvitec 14" Colour	229.00
Sanyo 14" Colour	229.00
Fidelity 14" Colour Monitor	199.00
Decca 14" colour TV/Monitor	263.00
Sanyo 12" Green	89.00

MISCELLANEOUS	INC VAT
Sanyo DR101 Data Recorder	39.95
Sanyo DR202 Data Recorder	44.95
Cassette leads - all types	2.80
Computerama Joystick interface	14.95
Quickshot Joystick (FOR BBC MICRO)	19.95
Printer Cable (Parallel) 1.2 m	9.95
BBC Micro Deluxe Cover	5.95
Light Pen	28.75

ORDER A COMPLETE SYSTEM

Deduct £1 from Software list prices

Data Cassettes 5 x C20/C15	1.95
The Plug Power Filter	14.95

VISIONS	INC VAT
Snooker	7.95
Digger	7.95
Daredevil Dennis	7.95
Nifty Lifty	7.95
Dermolater	7.95
Pengi	7.95
Galaxy Raider	5.50

PSION	INC VAT
Saloon Sally	6.95
VuCalc	14.95
VuFile	14.95

MELBOURNE HOUSE	INC VAT
The Hobbit	14.95
A Guide to Playing The Hobbit	4.95

MICROBYTE	INC VAT
Pinball	7.95

CLARES	INC VAT
B-Base	25.00
Replica II (Disc Only)	12.00
Graph Disc	12.95
The Key (Disc Only)	12.95
Shadow/Inspector	7.95
State 40/80T for Discs	

DR SOFT	INC VAT
747 Flight Simulator	8.95
Gorph	7.95
3D Convoy	7.95
Jump Jet	7.95

AMCOM	INC VAT
Fortress (C/D)	7.95/11.95
Space Highway	7.95

ADVENTURE INTERNATIONAL	INC VAT
The Hulk	9.95
Adventureland	9.95
Voodoo Castle	9.95
Secret Mission	9.95
Pirate Adventure	9.95

H. SOFT (WATFORD)	INC VAT
Penguin	7.95

ALLIGATA	INC VAT
Spiffire	7.95
Neanderthal Man	7.95
Blogger	7.95
Uncle Claude	7.95

HEWSON	INC VAT
Heathrow Air Traffic Control	7.95

A&F	INC VAT
Chuckie Egg	7.90
Cylon Attack	7.90
180 1 Darts	7.90

AARDVARK	INC VAT
Zalaga	6.90
Frak!	6.90

ADDICTIVE	INC VAT
Football Manager	6.90

MIRRORSOFT	INC VAT
First Steps With The Mr. Men	9.95

MICRO USER	INC VAT
Micro Olympics	6.90

MRM SOFTWARE	INC VAT
Q-Man	5.70
Q-Man's Brother	5.70
Diamond Mine	5.70
Guy In The Hat	5.70
3D Munchy	5.70
Castle Assault	5.70
Darts	5.70
Artist	9.95

Computerama

STAFFORD 59 Foregate Street Tel: (0785) 41899	STOKE-ON-TRENT 11 Market Square Arcade, Hanley Tel: (0782) 268620	SHREWSBURY 13 Castle Gates Tel: (0743) 60528
--	--	---

CONTENTS

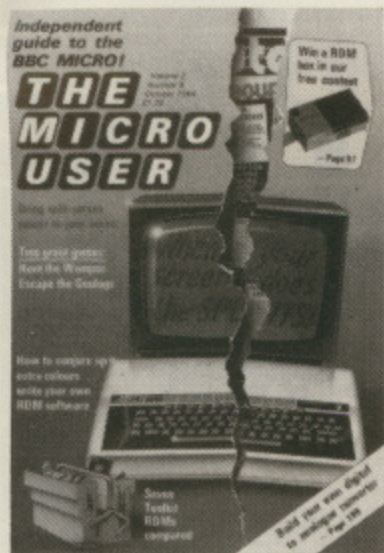

Vol. 2 No. 8 Oct 1984

Managing Editor
Derek Meakin

Features Editor
Mike Bibby

Production Editor
Peter Glover

Layout Design
Heather Sheldrick

Associate Editor
Alan McLachlan

News Editor
Mike Cowley

Technical Editor
Mike Cook

Advertisement Manager
John Riding

Advertising Sales
Mike Hayes
Margaret Clarke

Editor in Chief,
Database Publications
Peter Brameld

Tel: 061-456 8383 (Editorial)
061-456 8500 (Advertising)
061-480 0171 (Subscriptions)
Telex: 667664 SHARETG
Prestel Mailbox: 614568383

Published by:
Database Publications Ltd,
Europa House, 68 Chester Road,
Hazel Grove, Stockport SK7 5NY.

Subscription rates for
12 issues, post free:

£15 - UK
£15 - Eire (IR £18)
£20 - Rest of world
(surface)
£65 - Rest of world
(airmail)

ABC Member of Audit
Bureau of Circulations

The Micro User welcomes program listings and articles for publication. Material should be typed or computer-printed, and preferably double-spaced. Program listings should be accompanied by cassette tape or disc. Please enclose a stamped, self-addressed envelope, otherwise the return of material cannot be guaranteed. Contributions accepted for publication will be on an all-rights basis.

© 1984 Database Publications Ltd. No material may be reproduced in whole or in part without written permission. While every care is taken, the publishers cannot be held legally responsible for any errors in articles, listings or advertisements.

The Micro User is an independent publication and neither the BBC nor Acorn Computers Ltd are responsible for any of the articles in this issue or for any of the opinions expressed.

News trade distribution:
Europress Sales and Distribution Limited,
11 Brighton Road, Crawley, West Sussex
RH10 6AF. Circulation 0293 27053.

NEWS

23

Keep in touch with the latest happenings in the bustling world of the BBC Micro.

BEGINNERS

47

Take the pain out of programming. This month we show what READ and DATA can do.

WORKSHOP

51

Timed interrupts and the palette combine, allowing Mode 0 eight colours.

MAGNIFICENT 7

55

An in-depth comparison of the seven most popular programmers toolkits on ROM.

DISABLED

64

Keyboards can cause problems for some handicapped people. We examine alternatives.

BOOKS

66

We review two books - a collection of brainteasers and an easy guide to learning Basic.

PROBLEM PAGE

71

Mike Cook explains about the things you've always wanted to know but been afraid to ask.

PAGED ROM

75

How to make use of sideways RAM chips to write your own ROM type software.

ADVENTURES

80

Our forthright columnist takes another critical look at the world of adventures.

HUNT THE WAMPUS

84

Explore the labyrinth and track down the Wampus in our classic game of the month.

DOING THE SPLITS

92

This superb split screen utility helps you develop those major programs with ease.

COMPETITION

97

Your thoughts on improving Basic could win an external ROM box in our free competition.

3

Four great offers from

THE MICRO USER

Mini Office

Our big breakthrough in producing a low-cost introduction to business computers.

— Page 100

The Magic Sword

A unique package for younger micro users — a story book combined with a computer adventure.

— Page 111

Micro Olympics

If you're one of the few readers who hasn't yet bought our top-selling Olympics package, now's your chance!

— Page 127

Arcade Classics

Still in great demand — our popular collection of classic games, plus a real-time adventure.

— Page 162

103 SOFTWARE SCENE

The latest software releases assessed by our team of frank and thorough reviewers.

114 GOULOGS ESCAPE

Guide your balloon around the maze, avoiding the walls and gusts from the Goulogs.

119 HARDWARE SCENE

The 6809 second processor and a Basic extension ROM come under expert scrutiny.

128 SHOWTIME

All about our next big show at Alexandra Palace from October 25 to 28.

135 SECOND PROCESSOR

Further explorations of the 6502 second processor's fascinating extra instructions.

142 BIBLIOGRAPHY

We've often been asked for a comprehensive index to past issues. Now it's available on disc.

149 BODY BUILDING

Explore the synthesis of audio waveforms with a home made digital to analogue converter.

160 SOCKET & SEE

Continually replacing ROMs can cause problems. This is one DIY answer.

165 SHORT CUT

A program that enables you to write directly to integer variables and print them out.

201 MICROMAIL

The pages you write yourself. Just a small selection from the flood of letters pouring in.

215 INDEX

Your alphabetical guide to all the advertisers in this month's issue of *The Micro User*.

216 ORDER FORM

From back issues to covers, cassettes to cases, everything you need is here.

FROM THE AUTHOR OF THE TOP SELLING FELIX IN THE FACTORY

PLUTONIUM PLUNDER

Clear a path through the vault and shove the Radioactive Plutonium canisters behind the safety barrier before all hell breaks loose and the Megapods and oscillating Nuclids appear. Cassette: £6.95. Disk: £9.95.

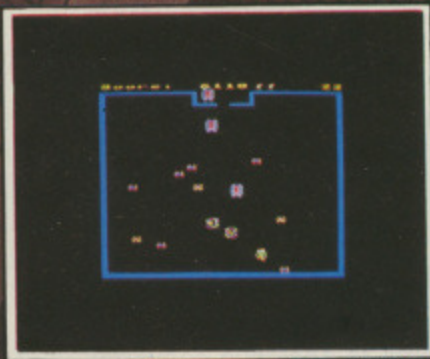

FOR THE
B.B.C. MICRO

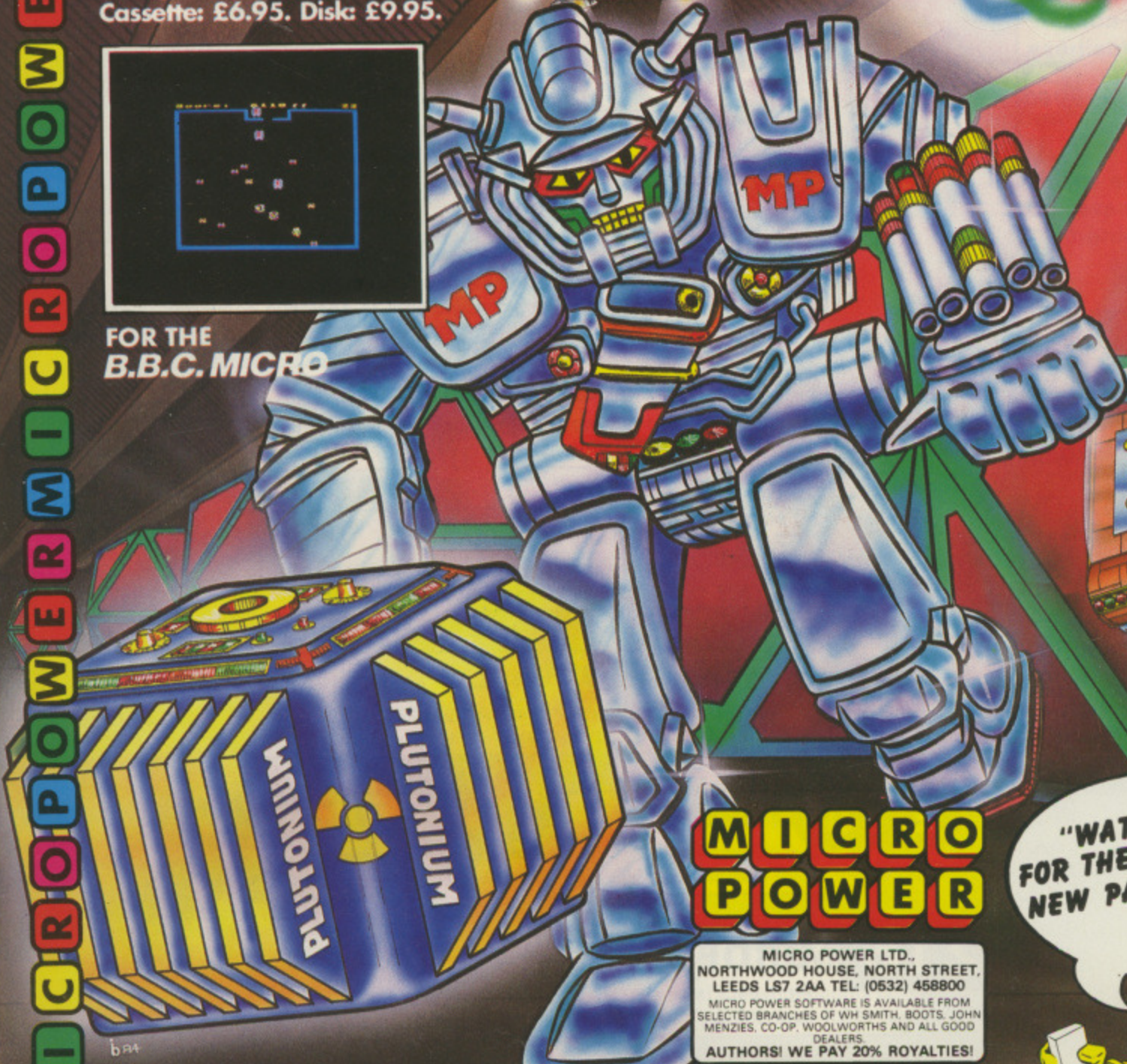

**MICRO
POWER**

MICRO POWER LTD.,
NORTHWOOD HOUSE, NORTH STREET,
LEEDS LS7 2AA TEL: (0532) 458800
MICRO POWER SOFTWARE IS AVAILABLE FROM
SELECTED BRANCHES OF WH SMITH, BOOTS, JOHN
MENZIES, CO-OP, WOOLWORTHS AND ALL GOOD
DEALERS.
AUTHORS! WE PAY 20% ROYALTIES!

"WATCH OUT
FOR THE FANTASTIC
NEW PACKAGING!!"

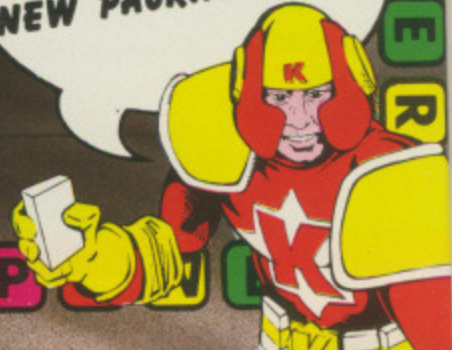

H
AT
on the
quality
to the
that's a
3" MICE
• Twice
line of
drives
• 200K
400K
• Easy to
• Low p
• Manu
Double
5 1/4" SIM
DRIVE
• All 1/2
• Low p
consu
• Comp
• Direc
5401 1
5402 2
5802 4
8
5 1/4" DU
DRIVE
• Meta
nece
• Sepa
• Utilit
5401D
5402D
5802D
FLOPI
3" cart
5 1/4" D
case.

HIGH QUALITY DRIVES AT EVEN LOWER PRICES.

Opus disc drives are the best buys on the market.

We have reduced our prices, but the quality still remains as high as ever.

All our 5¼" drives have been tested to their limits, running for 8,000 hours – that's a year of constant use.

And when you look at our prices, you'll find that VAT, all necessary leads and carriage are included along with a two year guarantee – a year more than any other company can offer.

You can order by posting the coupon below or calling at our showroom.

3" MICRODRIVE.

- Twice the capacity on line of other available drives.
- 200K Single Density – 400K Double Density.
- Easy to connect to the BBC Micro. • 3ms. Access time.
- Low power consumption – direct drive.
- Manual and free disc cartridge provided.

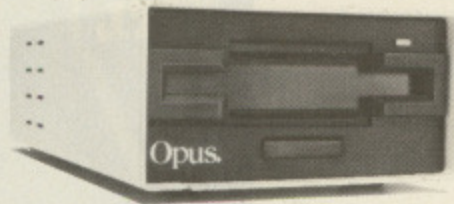

Double sided 40 Track Drive Single drive _____ **£199.95**
Dual drive _____ **£399.95**

5¼" SINGLE DISC DRIVES.

- All ½ height.
- Low power consumption.
- Comprehensive manual. • Free utilities disc.
- Direct drive mechanism. • Fast access time.

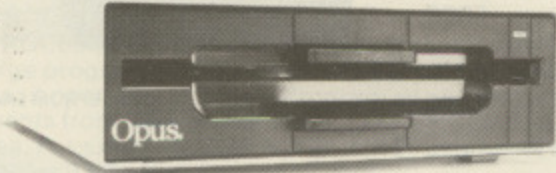

5401 100K Single sided 40 Track _____ **£149.95**
5402 200K Double sided 40 Track _____ **£169.95**
5802 400K Double sided hardware switchable
80/40 Track _____ **£199.95**

5¼" DUAL DISC DRIVES.

- Metal cased and all necessary leads.
- Separate power supply.
- Utilities disc and manual.

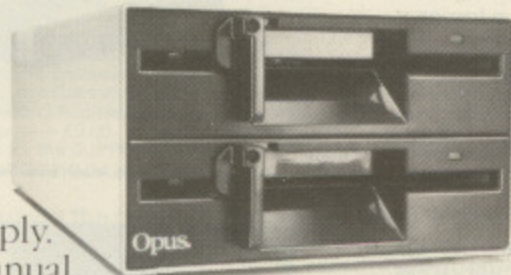

5401D 200K/400K on line S/sided 40 Track _____ **£349.95**
5402D 400K/800K on line D/sided 40 Track _____ **£399.95**
5802D 800K/1.6 Megabyte on line D/sided
hardware switchable 80/40 Track _____ **£499.95**

FLOPPY DISCS.

3" cartridge **£5.75** each or **£25.95** for 5.
5¼" Discs – with full 5 year warranty and free library case.
S/SS/D **£17.95** for 10.
S/SD/D **£19.95** for 10.
D/SD/D **£21.95** for 10.
S/S 80 Track **£25.95** for 10.
D/S 80 Track **£27.95** for 10.

DOUBLE DENSITY DISC INTERFACE.

The ultimate double density disc interface for your BBC Micro, compatible with 6502 2nd Processor.

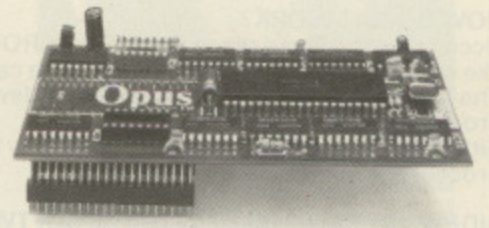

- Utilities on ROM including: Format and verify, tape to disc transfer, automatic 40/80 Track selection, automatic density selection, unique mass copy routine, powerful machine code operating system giving up to 248 files, 80% faster than single density. Easy to install. Free user manual supplied. _____ **£129.95**

GENEROUS EDUCATION AND DEALER DISCOUNTS GIVEN. ALL ITEMS ARE GUARANTEED FOR TWO YEARS AND ARE SUITABLE FOR USE WITH THE BBC MICRO.

OPUS SUPPLIES LTD.

158 Camberwell Road, London SE5 0EE.

Opening hours: 9.00-5.30 Monday-Friday, 9.00-1.00pm Saturday.



01-701 8668

01-703 6155

OPUS PRODUCTS ARE AVAILABLE FROM BOOTS, W.H. SMITHS, SPECTRUM, JOHN MENZIES, ALLDERS AND OTHER GOOD COMPUTER STORES NATIONWIDE.

To: Opus Supplies Ltd., 158 Camberwell Road, London SE5 0EE. Please rush me the following: **(ALL PRICES INCLUDE VAT & CARRIAGE.)**

Quantity	Description	Price

I enclose a cheque for £ _____ TOTAL.

Or please debit my credit card account with the amount of £ _____

My Access, Barclaycard (please tick) No. is _____

Name _____

Address _____

Telephone _____

BU31

Opus.
Opus Supplies Ltd.

SOLIDISK SIDEWAYS RAM: 8,000 UNITS SOLD

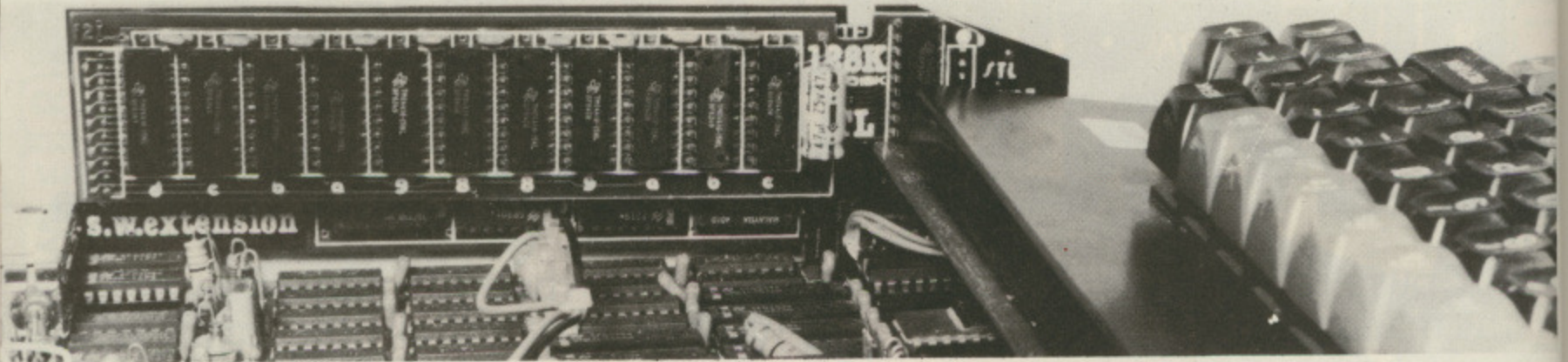

"Exciting" (ACORN USER JAN 84), "Power to your Beeb" (PCN 61, MAY 84)

HOW ABOUT COMPATIBILITY?

The Sideways RAM is completely compatible with all issues of BBC computers, disks, all sideways ROMs, second processor, Torch disk pack, Teletext, Econet etc. but NOT with ROM extension boards, since it can replace them.

Its power consumption is so low that you can use it in conjunction with twin disks.

HOW DOES IT WORK?

Occupying the same place as sideways ROMs (such as BASIC, DFS, CPN etc), it is treated like other Sideways ROMs and therefore can replace them.

The Machine Operating System uses Sideways RAMs as naturally as Basic, without procedures or programming rules.

Sideways RAM can run any language, any filing system including Hi-Basic and second processor DFS.

SIDEWAYS RAM POWER IS IN THE SOFTWARE:

Different from Sideways ROMs, Sideways RAM can be written into. This property gives birth to a NEW GENERATION of software for the BBC computer: SERVICE RAMs and VIRTUAL MEMORY PROCESSOR.

Each SERVICE RAM has its own commands and code as its counterpart Sideways ROM but has its own private workspace and storage area thus leaving you with the lowest possible PAGE value (PAGE = &E00). On the other hand, the Virtual Memory Processor can run huge MACRO BASIC programs (Megabytes are not the limit), keep them on disk and uses the basic 32k of RAM as transient program area. All software for the Sideways RAM system is free.

FREE SOFTWARE?

Solidisk Sideways RAMs is bundled with lots and lots of software, FREE and we mean FREE, now and later. It is quite simple: for every Sideways RAM sold, £1 is spent on MORE software. Sideways RAM users are invited to spot new applications and contributions are rewarded at the usual rate of £1 for every 4 bytes of machine code. The result is printed on the opposite page.

HOW ABOUT THE FUTURE?

Solidisk Sideways RAM is also widely used in schools for ECONET stations, by professional programmers for writing programs, research laboratories for RAM disk data base, at home for wordprocessing and now even games.

New areas are being developed: Telesoft and Teletext logging, Speech Processor assembler and Relational Data base to cite a few.

As the price of 16k EPROMs are as high as £20 at the present time, more Sideways ROM software publishers will be willing to sell their software on disk. Solidisk will mail FREE OF ANY COST their advertisement to ALL Sideways RAM users providing the price of the Disk version reflects savings in the cost of the ROMs. Solidisk believes that the majority of BBC users will have their Sideways RAM fitted before the end of next year.

Also unlike other makes (SIR, APTL, WE Sideways ROM/RAM extension boards and the Aries B20), Solidisk Sideways RAM is expandable from 16k right to 128k and now to 208K. As a result of VLSI technology and volume of sales, Solidisk products also have a lower shop price than any other products.

OTHER PRODUCTS FROM SOLIDISK:

UVIPAC EPROM ERASER:

Uvipac is powered by the mains, simple to operate and can erase 3 Eproms of any type in just 15 minutes. Uvipac is ideal for home use.

DETACHABLE KEYBOARD CASE:

Remove the keyboard from the BBC computer and instal it in the new case. Replace the old 3" keyboard tail by the new 24" cable and you can work really in comfort even for very long hours. The keyboard case is more a productivity tool than just ergonomics.

CPU CASE:

Replace the top of the BBC computer case by this metal CPU case. Sit your monitor on top (it is tough enough to take even your weight!). The CPU case has 2 compartments for half height 5.25" disk drives with fixing screws, air vents and provision for a bolt-on fan. At first sight, there is no trailing wire. Looking inside, there is enough room to accomodate Teletext Adapter, Second Processor, Solidisk and a fan!

DOUBLE DENSITY DISK INTERFACE:

2 versions of this double density interface will be available: as direct replacement for the Acorn Disk Interface (Version A) and as a Second Disk Interface (Version B) adding to your existing interface. They all use the same Western Digital controller chip (WD1770). Price £39.95 inclusive

DISK DRIVES:

3 models are being offered:

STL55A: 40 tracks single sided, SLT55F: 2 x 80 tracks, double sided and the best of mini floppy technology STL320: 2 x 160 tracks, double sided.

All disk drives are supplied with cables, formatter disk, head cleaning kit and 2 year warranty.

"Break the Ram Barrier" (A&B)

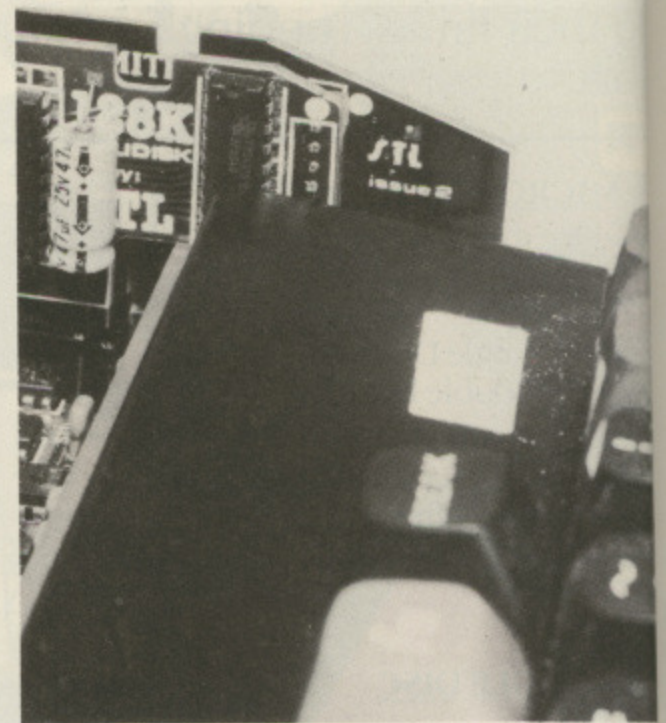

UVIPAC EPROM ERASER



TEAC DISC DRIVES FD55 Series

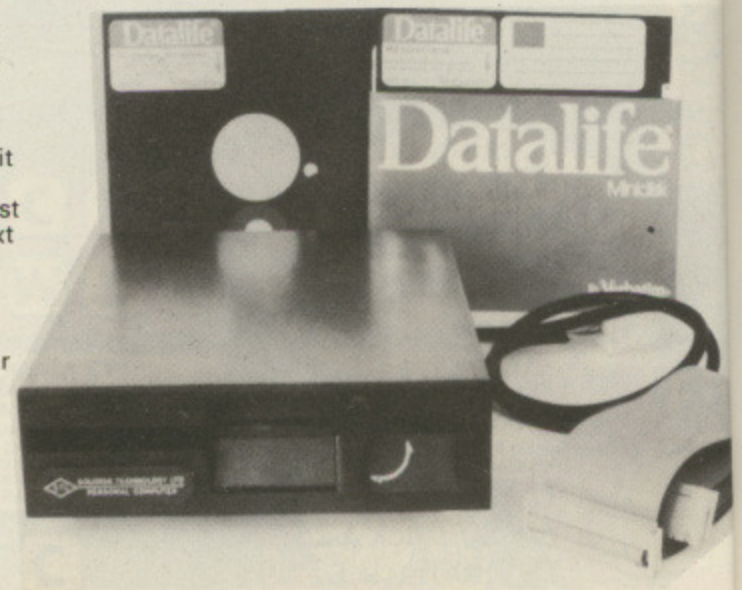

WHI

Solidisk
(SWR32
and the
now an
SWR32
exchang

FREE S
WORD
WORD
charact

SILEXIC
SILEX
a min
words

PRINTE
PRINTE
to 15K
long do

STLEO
STLOC
format

STL15
STL15
side.

STL-R
STL-R
applic
onto E
socket
disks,

INDEX
INDEX
such a
gives
numb

MACR
MACR
which
files (a
whic

VIRTU
VIRTU
back s
RAM
taking
from
asser

MEN
MEN
Firma

MOR
While
with
sidev
Each
wann
Ser

*It sh
softwa
the m
sided
For th
SILEX
Germ
Every

HOV
You
Acc
Edu

Nan
Adc

Cre

Cal

If o
onc

SO
17
SO
ES

WHICH SIDEWAYS RAM DO YOU NEED?

Solidisk Sideways RAM is available in 16k (SWR16), equivalent to 1 sideways ROM, 32k (SWR32), equivalent to 2 sideways ROMs, 128k (Solidisk), equivalent to 8 sideways ROMs and the 208k Solidisk equivalent to 12 Sideways ROMs. You can buy a small Sideways RAM now and upgrade it later. From the SWR16 to the SWR32 is by straight exchange, from the SWR32 to the Solidisk is by adding the 96k Solidisk Extension, from 128k to 208k is by exchange of the RAM card.

FREE SOLIDISK SOFTWARE:

WORD64:

WORD 64 is a Service RAM, it uses Solidisk as storage for WORDWISE, up to 64K free characters for any text.

SILEXICON:

SILEXICON is a Spelling Checker for Solidisk. SILEX scans texts at more than a 1,000 words a minute and compares each word against the dictionary, Silexicon marks the mis-spelt words for either addition to the dictionary or eventual correction.

PRINTER BUFFER:

PRINTER BUFFER is a Service RAM, it increases 500 times the normal 32 bytes printer queue to 15K bytes, completely transparent to the user. PRINTER BUFFER is as useful for printing a long document as for a short program listing.

STLEOO:

STLOO is a Service RAM, it is Disk Filing System that leaves PAGE at &E00, has built-in disk formatter/verifier and automatic track stepping for 40/80 track disk drives.

STL150:

STL150 is a Service RAM to enhance Acorn's .90 DFS to offer up to 150 directory entries per side.

STL-RFS:

STL-RFS (RAM/ROM filing system) is a Service RAM and an innovation in portable applications. STL RFS saves any program in a Sideways ROM format, it can then be copied onto EPROM to give instant recall of your programs. Plug this EPROM into any sideways socket, type *RFS and it runs itself. Compatible with the ELECTRON and BBC, tape and disks, SWR16, SWR32 and Solidisk.

INDEX:

INDEX is a Service RAM, it stores all the entry points of one or several sequential data files such as mailing list, stock list, accounts etc, merges, sorts them in alphabetical order and gives instant access to any record. INDEX can handle 1,100 records of any size, any type, any number of fields.

MACRO-BASIC:

MACRO-BASIC is a program generator. You use a wordprocessor to create a command file which is then scanned by MACRO. MACRO uses other programs, subroutine libraries, text files (actually any or all files on your disks) as source to generate a bug free BASIC program which can be very large (Megabytes are not the limit).

VIRTUAL MEMORY PROCESSOR:

VIRTUAL MEMORY PROCESSOR (VMP) uses extensively overlay technique and Solidisk as back store for very large programs that cannot be run otherwise. VMP uses the 32k basic RAM as transient area: it operates on a Main Program as generated by MACRO-BASIC, taking different segments from the Solidisk Store, POOL, HOLD, FREE or CLEAR segments from the transient area. For example: VMP will accept 20 segments of 10k of Basic assembler and assembles it into 16k of machine code.

MENU:

MENU puts all computer's resources at your fingertips. MENU displays your Sideways Firmare, Disk Directories, Sideways RAM system, Solidisk System etc.

MORE FREE SIDEWAYS RAM SOFTWARE TO COME:

While others are making promises for software to be written, Solidisk Systems RAM comes with a complete, novel and powerful software package including compatibility with existing sideways software.

Each Sideways RAM is accompanied by the Sideways RAM User Manual, full 1 year warranty, 1 utility disc* and free mailing on all new publications from the Software Support Service.

*It should be understood that we cannot put as much free software on a 40 track single sided as on a 80 tracks. The present software package require 160 tracks of storage and can be accommodated on ONE 2 X 80 track double sided diskette, only the most useful programs are supplied on other formats (ie 40 track single sided, 2 X 40 track double sided, 80 track single sided). Should you require the whole collection of free software, please place an order for extra disks.

For the technical minded: the Source Code and Technical Manual (3 floppies and a 300+ page book) price = £10, the SILEXICON EXTENSION PACKAGE (3 floppies and a 40 page mnual, 30,000 word dictionary: English and French now, German and Spanish planned) price = £9.00. *4S* also publishes regular updated SWR utility discs at £3.00. Every user can do contract work for the SUPPORT SERVICE and make a lot of money for him/herself!

HOW TO ORDER?

You can order any item using the coupon. Post and packing is only charged once. Access and Barclay card holders can place their order by phone. Educational authorities, Acorn dealers and OEMs can obtain quantity discounts.

Name:

Address:

Credit Card Account:

Callers are requested to ring first for appointment.

Total: £

If ordering more than one item, deduct £1 per item as post and packing cost is only charged once.

SOLIDISK TECHNOLOGY LIMITED
17 SWEYNE AVE
SOUTHEND-ON-SEA
ESSEX SS2 6JQ

SOLIDISK'S NEW TELEPHONE NUMBER:
SOUTHEND-ON-SEA (0702) 354674
(10 lines with automatic exchange)

HOW EASY TO INSTALL:

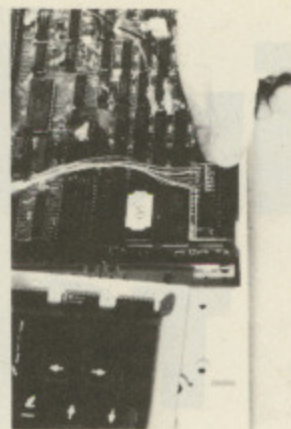

Push in the base unit

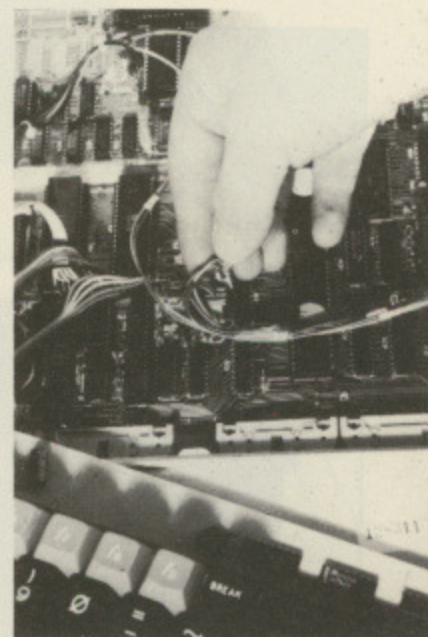

Connect the control wires

PRICE LIST (including VAT and post & packing)

SIDEWAYS RAM:	
SWR 16K	£43.65
SWR 32K	£59.95
128K SOLIDISK	£150.95
208K SOLIDISK	£243.00

The following are upgrade prices for existing Sideways Ram owners:	
16 - 32 (please return complete item)	£18.00
16 - SOLIDISK (please return complete item)	£109.00
32 - SOLIDISK (no return necessary)	£93.00
128K - 208K SOLIDISK	£93.00

DISK DRIVES:	
STL55A (40 track, single sided, cased with cables, diskette, manual and 2 years warranty)	£142.95
STL55F (2 X 80 track, double sided, as above)	£232.95
STL320 (2 X 160 tracks, double sided, as above)	£499.00

FLOPPY DISKS (DATALIFE Verbatim):	
MD525 (SS/DD 40 or 80 track) box of 10	£16.00
MD550 (DS/DD 40 or 80 track) box of 10	£22.00
MD557 (DS/DD 98 TPI) box of 10	£27.00

CPU CASE	£13.00
DETACHABLE KEYBOARD CASE	£27.99

EPROM PROGRAMMER (used with Sideways Ram)	£16.00
UVIPAC EPROM ERASER (free standing unit)	£20.95
2764 PACK OF 5	£36.00

SOURCE CODE + TECHNICAL MANUAL	£10.00
SILEXICON EXTENSION PKGAGE	£9.00

WE STOCK A LARGE RANGE OF PRINTERS AND MONITORS. CALL OUR SALES OFFICE FOR IMMEDIATE QUOTATION.

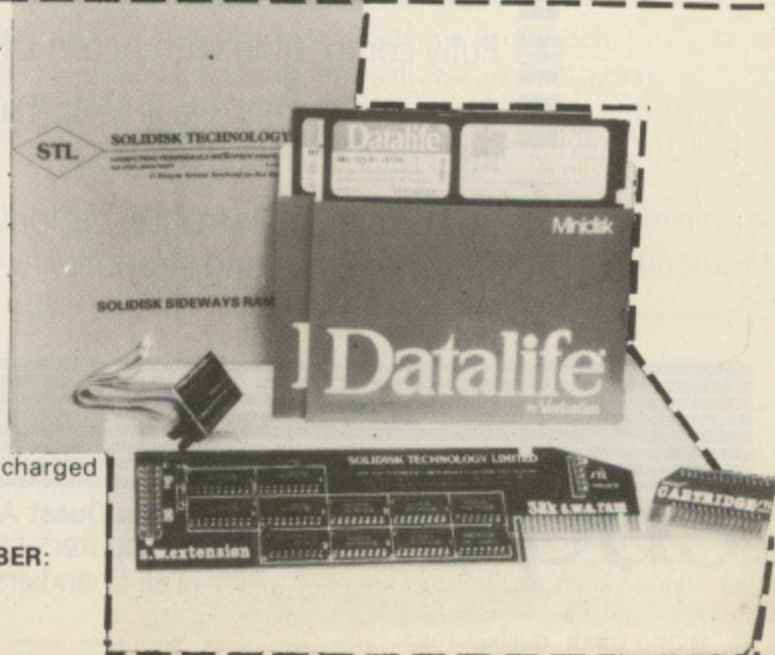

Firefly Hard Disk for your BBC

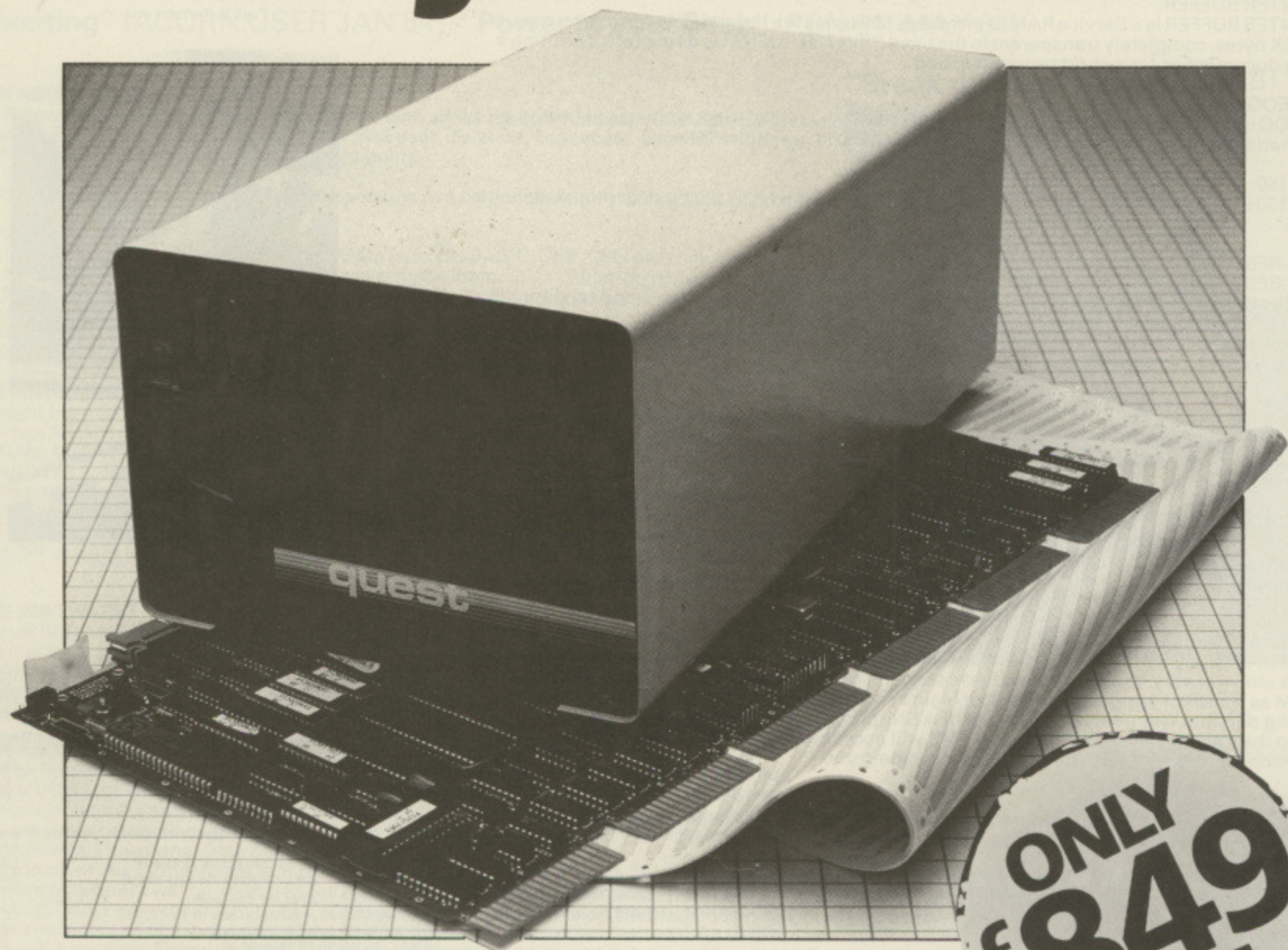

- 7.5 Mb of formatted data storage
- Fast, compact and reliable
- Unlimited number of files per disk
- Fully compatible with Acorn DFS
- Connects simply, via 1 MHz Tube interface and plug-in ROM
- Full 6 month warranty; nationwide Quest engineering support

■ Early delivery

Professional users of the IBM PC, DEC Rainbow and ACT Apricot and Sirius are already aware of the advantages of Quest's Firefly Winchester Disks in capacities of from 7.5 to 115 Mbytes, and now one of the Firefly family, the Firefly B, is available to users of the BBC micro.

As specialists in the production and distribution of Winchester disks, Quest have been able to negotiate the keenest possible price for the Firefly B and now offer its benefits to all BBC users.

To order, simply call Chandlers Ford (04215) 66321.

**ONLY
£849
+ VAT**

quest

Part of the Quest Automation plc Group of Companies.
Quest International Computers Ltd, School Lane, Chandlers Ford, Hants SO5 3YY.
Tel: Chandlers Ford 66321 Telex: 47326

H

colour
there is
periods
resolut
for a be

Comput

resolut
simply
and tex
clear, l
Microv
questio

470 pix
saving
of simil

BBC Mi
and mo

MODEL
RESOLU
C.R.T.
SUPPLY
E.H.T.
VIDEO
DISPLA
SLOT P
INPUT
SYNC
EXTER



HIGH RESOLUTION THAT COMES HIGHLY RECOMMENDED.

"There is no doubt that the JVC range of ECM colour monitors is excellent value for money . . . there is no loss in quality of picture after long periods . . . and remember, as more and more resolution is available with new micros, the need for a better display will be that much greater."

High recommendation indeed from Personal Computer News. Meanwhile Acorn User said:

"It seems that all 'normal' and 'medium' resolution monitors, including the Sanyo, are simply inadequate to deal with the Beeb's graphics and text output . . . The JVC was excellent, giving clear, legible results . . . Was the JVC better than the Microvitec?* Would I buy one? Yes to both questions."

Our RGB high resolution colour monitor (580 x 470 pixels) sells for £229.95 (excluding VAT) – that's a saving of over £100 compared with other leading monitors of similar specifications.

The unit has a 14" screen and is suitable for the BBC Micro, Electron, Sinclair QL, Lynx, Oric, Apple, IBM and most other leading micros.

MODEL REFERENCE	1302-2 High Resolution
RESOLUTION	580x470 Pixels
C.R.T.	14"
SUPPLY	220-240v. 50-60Hz.
E.H.T.	Minimum 19.5kv Maximum 22.5kv
VIDEO BAND WIDTH	10MHz.
DISPLAY	80 characters by 25 lines
SLOT PITCH	0.41mm
INPUT: VIDEO	R.G.B. Analogue/TTL Input
SYNC	Separate Sync on R.G.B. Positive or Negative
EXTERNAL CONTROLS	On/off switch and brightness control

And naturally there's a year's full guarantee.

If you order your monitor by post, you'll receive it within ten days by courier service.

Simply post the coupon below to: Opus Supplies Ltd., 158 Camberwell Road, London SE5 0EE. Or telephone 01-701 8668 quoting your credit card number. Or, of course, you can buy at our showroom between 9.00–5.30pm, Monday–Friday, 9.00–1.00pm, Saturday.

*Microvitec Cub 14" monitor.

To: Opus Supplies Ltd., 158 Camberwell Road, London SE5 0EE.
Please send me:

_____ High Resolution Colour Monitor(s) at
£229.95 each (ex. VAT).

_____ Medium Resolution Colour Monitor(s) at
£179.95 each (ex. VAT).

_____ Connection lead(s) at £6.00 each.

I understand carriage per monitor will cost an extra £7.00.
(N.B. A High Resolution Monitor including VAT, lead, and carriage costs £279.95. A Medium Resolution Monitor including VAT, lead and carriage costs £221.89).

I enclose a cheque for £_____ Or please debit my credit card
account with the amount of £_____. My Access/Barclaycard
(please tick) no. is _____

Please state the make of your computer _____

Name _____

Address _____

Telephone _____

Opus.
Opus Supplies Ltd.

B-BASE: £25—8 Great Features

WHAT IS A DATABASE?

It is a FILE which contains RECORDS. Records consist of a number of FIELDS containing the information—an analogy can be drawn with a card index in which a box of cards is the file. Each card is a record and each line on the card is a field.

SPECIFICATION

- 1) Random Access—disc based, single or dual drives
- 2) File Size—99K (40 track), 199K (80 track) —65,000+ records
- 3) Record Size—up to 2048 characters and 200 fields
- 4) Field Size—up to 254 characters with complete line scanning
- 5) Access any record using Primary Key in 2 seconds
- 6) Holds—1200 NAMES AND ADDRESS records on 100K disk
- 7) Search—500 records on 5 fields in 60 seconds
- 8) Sort—500 records on 3 fields in 60 seconds

SYSTEM FEATURES

SEARCH PARAMETERS = .< .> .> = .< = .< .> . INSTR

CALCULATE—Global or local totals and functions using any valid BBC expression

POWERFUL PRINTOUT OPTION—

Eliminates need for separate mailing program, Parallel/Serial Printout allows setting of printer control codes, line spacing, tabulation, Headings etc, plus label printing with horizontal and vertical tab control.

REDEFINE—Titles, field widths, number of fields etc.

TRANSFER—Records from one file to another

SEARCH LISTS—Allow creation of sub-Databases within main Database but without having to save data again.

DATE FORMATS—6 formats for print out

All timings and sizes are relative to ACORN DFS. Compatible with ACORN DFS, WATFORD 1.3 and latest AMCOM DFS.

Send S.A.E. for detailed data sheet

All Disc Software now available on 3" disc—add £3 to printed prices

REPLICA II: £12.00.

The original REPLICA set a very high standard so the specification we set our chief programmer included some impossible features. In fact ACORN state that some of the things that we have done are impossible, it just took us longer that's all. REPLICA II transfers most cassette based programs to disk, even more than REPLICA. When you buy disk drives you do not have to throw away expensive cassette based programs.

REPLICA II transfers 'LOCKED' programs, programs loading as files, programs that load below &E00, those with up to 6 sections and those up to &6E in length eg adventure programs. No waiting for 6 minutes whilst adventure programs load.

REPLICA II is very easy to use. The user enters a name, how many sections and whether CHAIN, RUN or LOAD to load the first section. Press play and let the program do the rest, even a menu.

Think how much it will cost you to buy just 1 disk version of your favourite program—REPLICA II which will hold up to 16 programs limited only by the disk capacity.

CLARES NO1 IN UTILITY SOFTWARE!

THE KEY: £12.95



The original disk utility program for the BBC that provides the user with the tools to explore the disk environment and use it to its best advantage. The programs are:

- 1) FORM40—Formats and verifies 40 track disks.
- 2) FORM80—Formats and verifies 80 track disks.
- 3) BACKUP—Allows backup copies of your valuable disk to be made.
- 4) EDITOR—Enables the user to read the disk sector by sector and to alter programs on the disk, even most protected and unlistable ones. More fun than any adventure game.
- 5) RETRIEVE—Allows the user to recover data or programs that have been accidentally erased or damaged by a head crash.

Every disk owner should have one. Recommended by: WHICH MICRO; EDUCATIONAL COMPUTING etc.

JOYSTICK UTILITY: £6.00



Converts non joystick programs to work with joysticks. Works with any program using INKEY (-) in Basic or machine code, to detect movement, which applies to most programs. The routine is relocatable and sensitivity of the joystick can be varied. Compatible with most games, including Acornsoft. Very easy to use, just press the keys you want to transfer. The machine code can be saved as a block of just 100 bytes. Supplied on cassette but can be transferred to disk.

SHADOW: £8.00

SHADOW is a tape cloning program that makes security copies of your valuable cassette software. SHADOW works with 99% of all known programs including those with sections at 300 BAUD and those that load as files. SHADOW will handle programs with any number of sections and it will work with any of the current operating systems

including 0.1, 1.0 & 1.2 SHADOW is the definitive tape backup system and as a bonus you also get 'INSPECTOR' on the same tape. This allows you to view all areas of memory, search and alter bytes, etc. Colour coding helps to simplify memory usage.

"It is a condition of sale that this program is not used for piracy."

JOYSTICKS: £17.95

BBC JOYSTICKS—Fully proportional joysticks in smart, sturdy injection moulded cases. 1.5 metres of cable, long life mechanism gives precise operation. British made.

THE NO1

All prices inclusive of VAT & Carriage—NO EXTRAS!

We're not short of Utility Software.

Clares[®]

MICRO SUPPLIES

98 Middlewich Rd.,
Northwich, Cheshire CW9 7DA
Tel: 0606 48511
Open 9—5pm Monday—Friday

MU10

gh
set our
impossible
t some of
possible,
PLICA II
ograms to
hen you
throw
ograms.
ograms,
ns that
o 6
ngth eg
r 6
s load.
user
and
load the
program
buy just 1
am—
capacity.

E!

he
s a
the
l areas
c.
ory
gram is

oulded
British

ge—

re.

DA



OUR DOUBLE-SIDED 3" DISC DRIVE. A TRIUPLE OFFER.

Opus have a triple offer of 3" disc drives for those who wish to improve their micros.

The disc drive is compatible with the BBC Micro, has a direct drive mechanism, is double-sided and comes with a comprehensive manual.

And with every purchase, a 3" utilities cartridge will come free.

Our offer also includes VAT, all necessary leads

and carriage along with a two year guarantee—which is a year more than any other company can offer.

You can order by posting off the coupon below or calling at Opus Supplies Ltd., 158, Camberwell Road, London SE5 0EE. 01-701 8668 or 01-703 6155.

We are open 9–5.30 Monday to Friday and 9.00–1.00 p.m., Saturdays.

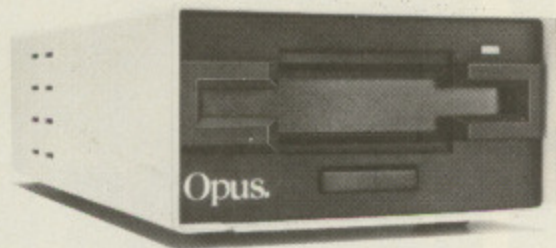

3" DISC DRIVE

You can buy this 500K (Unformatted) double-sided disc drive for the same price that other companies sell single drives for. The drive heads read and write to and from both sides of the disc cartridge, giving you twice the on-line capacity of single 3" drives.

Normally ~~£229.95~~

Now £199.95

SAVE £30

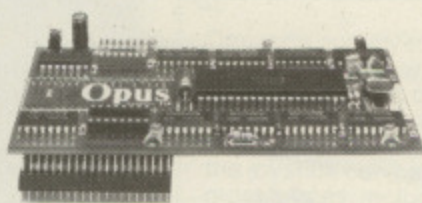
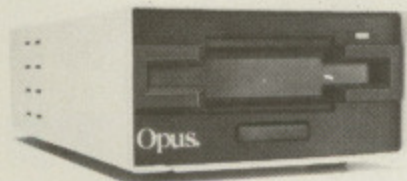

3" DISC DRIVE AND DOUBLE DENSITY INTERFACE

If you currently run your program on a cassette recorder, you'll need to upgrade your micro in order to use a disc drive. This offer not only gives you an interface, but it effectively doubles the capabilities of the drive—giving you 350K of usable capacity instead of the 200K normally achievable.

Normally ~~£359.95~~

Now £299.95

SAVE £60

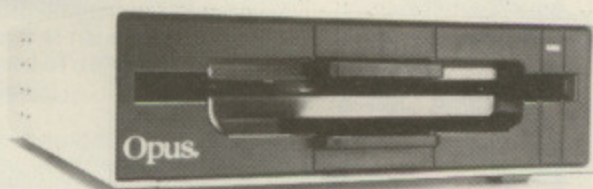
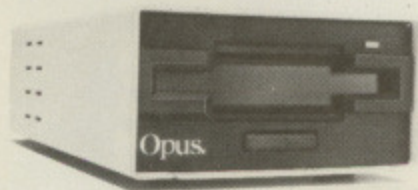

3" DISC DRIVE AND 5 1/4" DISC DRIVE

Both drives come 'daisy-chained' (or linked) together. They're completely compatible and will allow you to download all those programs you made on 5 1/4" floppy discs onto a robust 3" cartridge.

Normally ~~£379.95~~

Now £329.90

SAVE £50

Quantity	Description	Price

I enclose a cheque for £_____ TOTAL

or please debit my credit card account with the amount of £_____

My Access/Barclaycard (please delete)

No. is _____

To: Opus Supplies Ltd., 158 Camberwell Road, London SE5 0EE. Please rush me the following: **(ALL PRICES INCLUDE VAT & CARRIAGE.)**

Name _____

Address _____

Telephone _____

BU30

Opus.
Opus Supplies Ltd.

ED

tee-which
an offer.
pon below

day and

ble-sided
es sell
te to and
twice the

9.95

FACE

cassette
ler to use
ce, but it
ving you
nally

9.95

d)
ll allow
on 5 1/4"

90

E. Please
IAGE.)

IS.
Supplies Ltd.

STOP!

IF YOU'RE AN ACORN USER, YOU NEED TO BUY THE BEST!

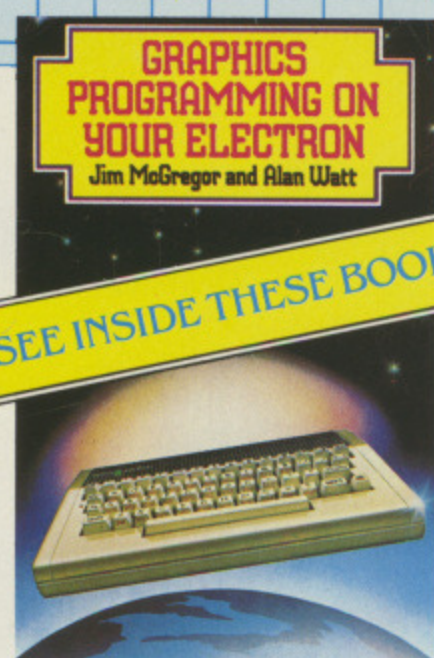

WRITE A WINNING PROGRAM AND WIN VALUABLE PRIZES! SEE INSIDE THESE BOOKS

Energise your Electron

- * A thorough grounding in BASIC.
- * Structured programming techniques.
- * Packed with lots of examples.

Develop your graphic skills to the full

- All you need to know to produce:
- * Graphs * diagrams * pictures * 'three-dimensional' displays * plus many other designs.
 - * Crammed with practical and challenging exercises.
 - * Backed by thought-provoking examples.

MAKE THE MOST OF YOUR MICRO —
PUT YOURSELF IN THE PICTURE! WITH THREE
NEW BOOKS BY JIM MCGREGOR AND ALAN WATT,
AUTHORS WHO STAND "HEAD AND SHOULDERS
ABOVE THE REST." (MICRO USER)



CORGI/ADDISON-WESLEY

TOGETHER,

THE NEW FORCE IN COMPUTER BOOK PUBLISHING



All these books are available at your bookshop, though should you find any difficulty in obtaining them, they can be ordered direct from the publisher. Simply fill in the form below.

Please send me

- ___ 99103 1 Better Basic for Your Electron at £4.95 (192 pages)
- ___ 99102 3 Graphics Programming for Your Electron at £4.95 (176 pages)
- ___ 99104 X Graphics Programming for Your BBC Micro at £4.95 (192 pages)

Please allow cost of book(s) plus 30p for one book plus 15p for each additional book for postage and packing.

I enclose my cheque/postal order for £ _____ payable to: TRANSWORLD PUBLISHERS LTD.

(IN BLOCK CAPITALS PLEASE)

Signed _____ Date _____

Name _____

Address _____

Now send to CORGI/ADDISON-WESLEY BOOKS,

61-63 Uxbridge Road, London W5 5SA

®



The Graduate.

The first IBM PC
compatible upgrade
for the BBC model B micro.

Fro
you

Dis
with th
the late
range o
MS™-D
custom
allowin
range o
softwar
compil
availab
houses.

TH
of upgr
G800,
user m
(optio
increa
IBM c
The G
double
drive a
introd

From only £764.00 the new Torch Graduate will upgrade your BBC Model B to a powerful 16 bit business computer

TECHNICAL SPECIFICATION

- 8088 16-bit processor running at 5 Mhz
- 128K or 256K RAM
- MS™-DOS operating system customised to IBM compatibility
- Model G400 - Single, double sided, high density disc drive (320K formatted)
- Model G800 - Twin, double sided, high density disc drives (640K formatted)
- Integral stabilised power supply
- 2 IBM PC compatible hardware expansion buses
- Software compatibility allows Lotus 1-2-3 and all popular IBM PC business programs to run without modification, subject to the constraints of the BBC keyboard and display
- Disc interface is not required
Keyboard text and graphics supplied by BBC Model B

• THE GRADUATE •

Disc and hardware compatible with the IBM PC, the Graduate is the latest addition to the Torch range of BBC upgrades. It's MS™-DOS operating system is customised to IBM compatibility allowing exploration of the massive range of IBM compatible business software, programming aids, compilers and languages universally available from most major software houses.

Introduction to MS™-DOS

The Graduate offers two levels of upgrade, the G400 and the G800, both with 128K on board user memory as standard (optionally 256K). This can be increased to 1.2 Mbytes with an IBM compatible expansion board. The G400, contains a single, double sided 320K formatted disc drive and provides the low cost introduction to MS™-DOS for the

user who wants real 16 bit power from his Model B.

More data storage

A step up from the G400 is the G800 which offers twin, double sided 320K disc drives for extra data storage. Both the G400 and the G800 provide the possibility of further expansion for networking, modems, etc., via the IBM compatible hardware slots provided

by the Graduate models. Each model comes complete with a well written user/technical manual and connecting leads.

Just plug it in

Unlike other add-ons there is no need to open the BBC to make the connection. The compact and tidy Graduate models simply plug in to the 1MHz bus on the Model B. Within minutes you can be up and running with an IBM PC compatible system that really means business.

The range

Add 256K RAM, 640K disc storage and IBM PC compatibility to the BBC Micro for less than £1,000.

Graduate G400 (128K) £764 inc. VAT
Graduate G400 (256K) £815 inc. VAT
Graduate G800 (128K) £949 inc. VAT
Graduate G800 (256K) £999 inc. VAT

For further information complete the coupon today.

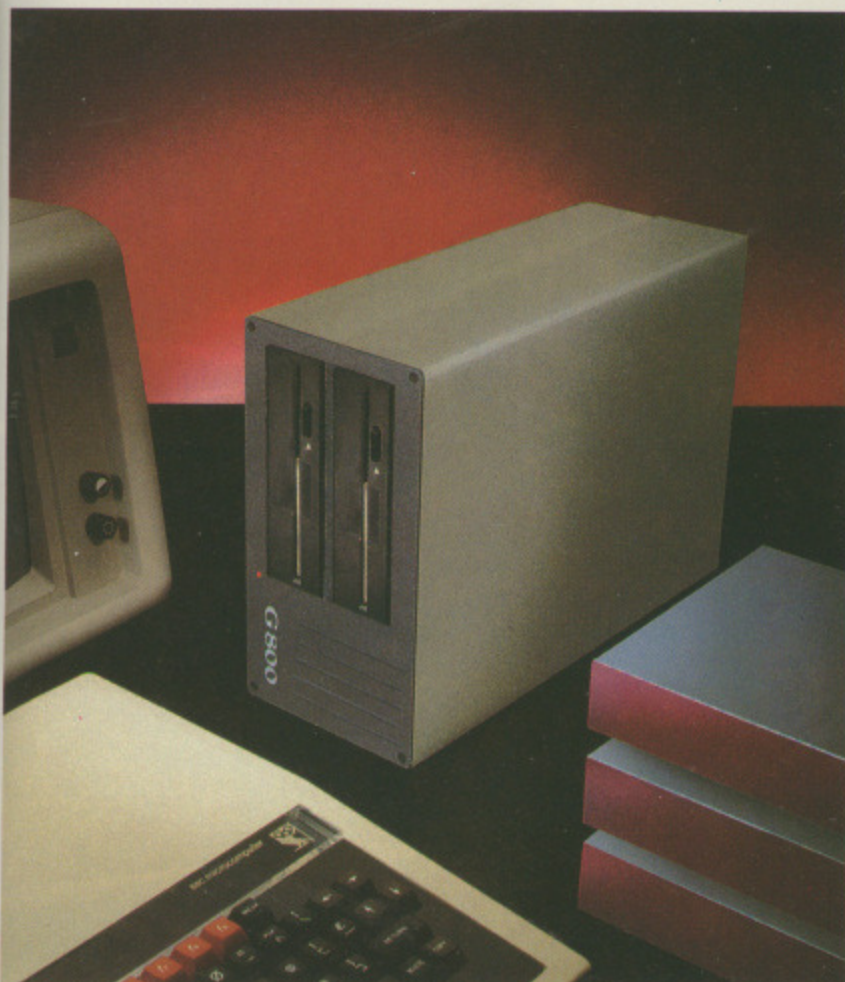

TORCH COMPUTERS



Lighting the way ahead.

Torch Computers Limited
Abberley House, Great Shelford, Cambridge CB2 5LQ.
Telephone (0223) 841000. Telex 818841 TORCH G.

The Graduate is manufactured by Torch Computers under licence from Data Technologies Ltd.

To: Torch Computers Ltd., Abberley House, Great Shelford
Cambridge CB2 5LQ. Telephone (0223) 841000
Please send further information on the Graduate and the
address of my nearest dealer.

Name _____

Address _____

Post Code _____

Telephone _____

MU10

Introducing BEEBUGSOFT

Until recently a very special range of applications and utility packages for the BBC micro has been unavailable to the general public.

This software has been produced by the BBC user group BEEBUG for its members. BEEBUG members tend to be a demanding and discerning group of individuals; and the range of software produced has been kept to a consistently high standard through their constant vigilance.

As a result, BEEBUG software is highly acclaimed amongst BEEBUG's 25,000 members. Independent reviews from the major computing magazines seem to take a similar view of the software, as you can see from their comments.

SPELLCHECK

The disc based spelling checker for text created on Wordwise or View.

"... invaluable ... fast and reliable ... a worthwhile investment"
PCN February 1984
Disc £19.00

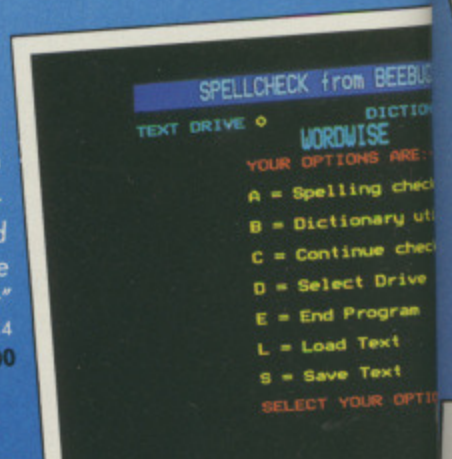

TOOLKIT

27 new commands in eprom to speed up Basic program development and debugging.

"... an indispensable aid"
EDUCATIONAL COMPUTING March 1984
"... worth every penny ... highly recommended"
COMPUTING TODAY June 1984
"... its range of utilities is excellent"
MICRONET May 1984
Eprom £27.00

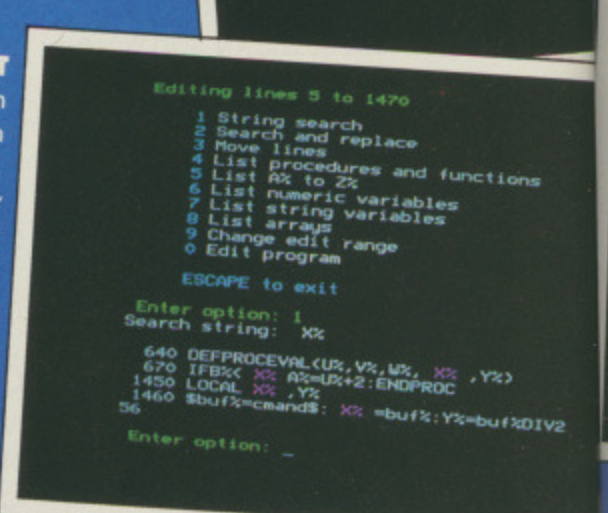

SPRITE UTILITIES

A game writers utility pack enabling high speed arcade games to be quickly written in Basic.

"... definitely recommended ... excellent"
ELECTRONICS AND COMPUTING May 1984
"... Sprite Utilities wins through"
ACORN USER May 1984
Cassette £10.00
Disc £12.00

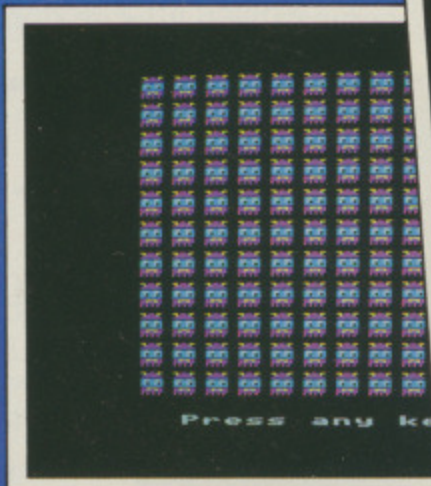

PAINTBOX

Probably the ultimate joystick drawing package on the BBC Micro, great fun and highly educational.

"... amazingly versatile ... easy to use ... (one of the most feature laden picture creating programs around) ... tremendous potential"
EDUCATIONAL COMPUTING Jan 1984
"... a very sophisticated and versatile utility"
ELECTRONICS AND COMPUTING May 1984
Cassette £10.00
Disc £12.00

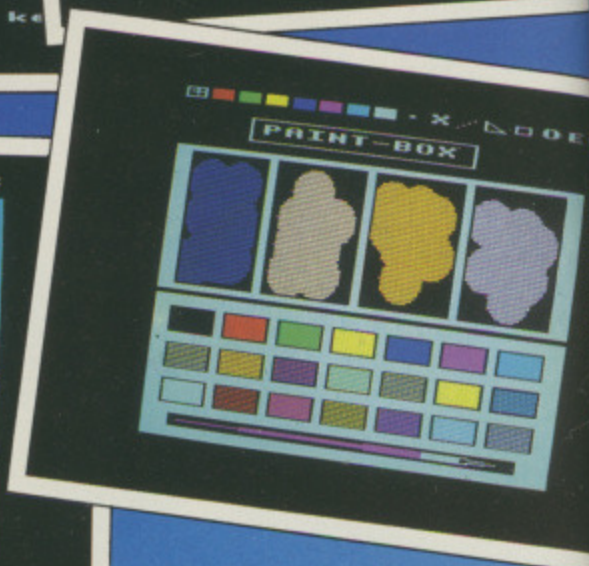

CHECK from BEEBUG
 DICTIONARY
 WORDWISE
 YOUR OPTIONS ARE:
 A = Spelling check
 B = Dictionary ut
 C = Continue check
 D = Select Drive
 E = End Program
 L = Load Text
 S = Save Text
 SELECT YOUR OPTIO



TELETEXT PACK
 A powerful screen editor for quickly creating Teletext Mode 7 screens.
 "... provides teletext editing facilities in a well thought out manner"
 ELECTRONICS AND COMPUTING April 1984
 "... a very neat utility"
 MICRONET April 1984
 Cassette £10.00
 Disc £12.00

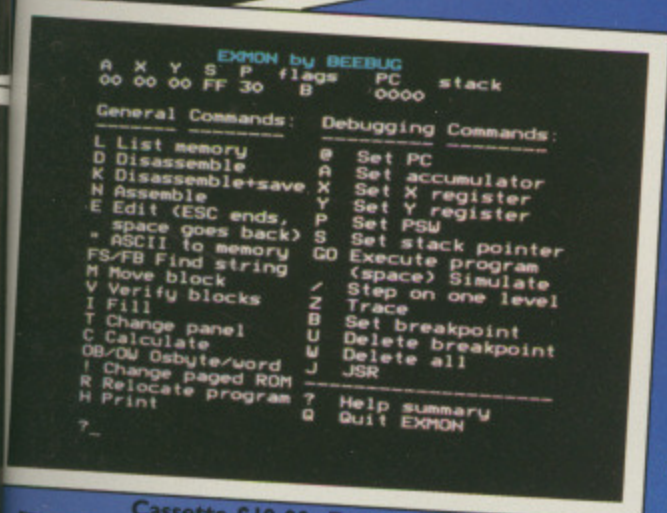

EXMON
 An extremely powerful machine code monitor on cassette or eprom, offering 35 new commands for debugging machine-code.
 "... exceptionally comprehensive... would be hard to improve upon"
 YOUR COMPUTER August 1983
 "... using EXMON is a delight"
 MICRONET May 1984

Cassette £10.00 Eprom £27.00

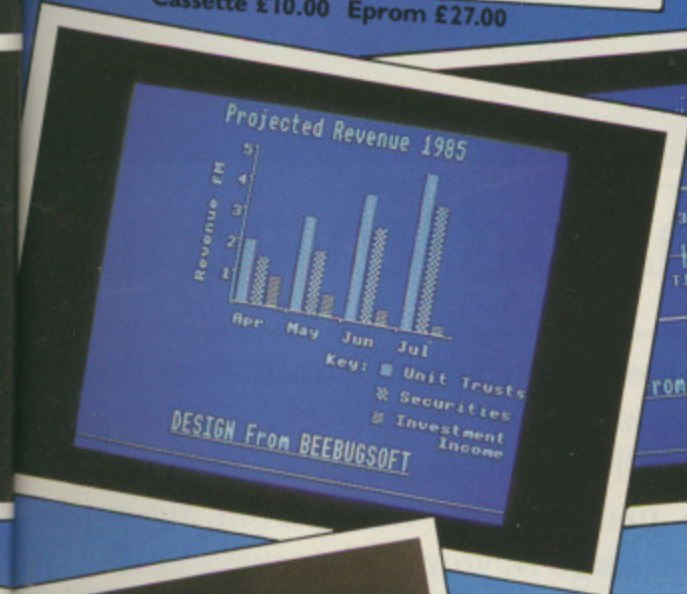

Cassette £10.00
Disc £19.00

DESIGN
 A Computer Aided Design package to allow screens to be quickly created for display, demonstration, handouts etc.
 "... a first rate screen processor... immense value to schools and colleges"
 EDUCATIONAL COMPUTING April 1984

BEEBUGSOFT products may now be obtained from major dealers including selected branches of W.H. Smith.

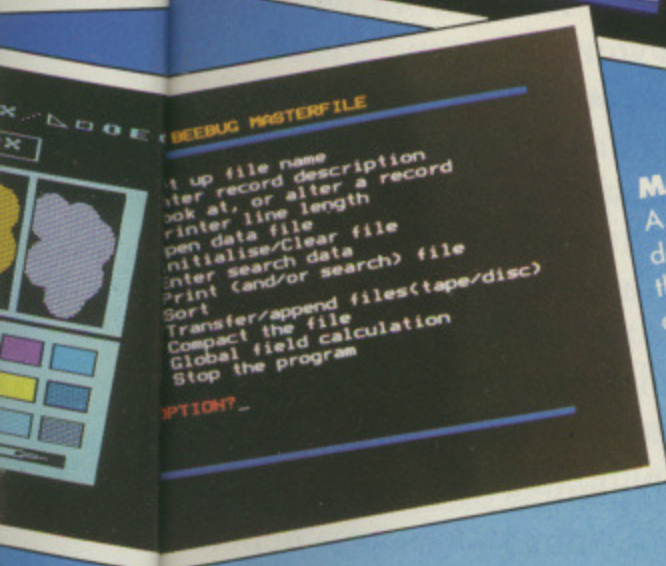

MASTERFILE
 A flexible general purpose database on cassette or disc; the disc version using random access files.
 "... works well and offers an efficient database"
 PCN November 1983
 Cassette £10.00
 Disc £19.00

Alternatively all products are available from us on mail order from our despatch department in High Wycombe.

BEEBUGSOFT dept 16 PO BOX 109
 HIGH WYCOMBE BUCKS HP10 8HQ

**TEL: ST. ALBANS
 (0727) 60263**



Prices include VAT



Will you be the first Earthling to win a place

Acornsoft are issuing a nationwide challenge to all Acorn Electron and BBC Micro users.

It's the challenge to join a new and exclusive group of computer games players: The Elite.

With 3-dimensional graphics, Elite is a game which is light years ahead of any other.

It strictly defines the rank of each and every player.

As your prowess improves, you move into higher ranks.

But make no mistake, to reach the top rank, your performance must become exceptional.

Then, and only then, will you qualify to call yourself a member of The Elite.

From harmless, you must become lethal.

In Elite, all players start as equals.

With the initial rank of "Harmless," you will

embark upon an experience unlike any that you have known before.

You will be a space trader who roams the universe, making your living from buying and selling the cargo in your Cobra space craft.

On your travels, you will encounter aggressors who are eager to put an end to your dealings.

Only the fittest will survive.

As you establish yourself as a survivor, you will win the right to a higher rank.

In all, there are nine, from "Harmless" to "Elite." And your computer will continually tell you where you stand.

Trade with 2,000 planets in eight galaxies.

Besides survival, your success also depends on the rewards you reap from the cargo that you carry.



...a place among the Elite?

ny that you
ams the
uying and
craft.
aggressor
alings.

That cargo can be anything from foodstuffs to contraband. If you decide to trade in contraband, the rewards will certainly be higher. But so will the risks you take.

To ply your trade, you can dock at any of 2,000 planets in eight galaxies.

However, before you dock, you must use your wits to assess the planet's political climate and the perils which may be waiting for you.

Also, in any of the eight galaxies, you may find yourself being asked to perform acts of considerable heroism and selfless courage.

Although these will bring you into danger, they can bring considerable rewards too.

We're waiting to recognize your skills.

Achieving higher status in Elite will tax your skills to the limit. Which is why you must down-

load your game onto cassette or disc each time you take a break from play.

When you reach the rank of "Competent" or higher, you should send us the secret code number revealed to you by your computer.

We will send you in return a special document which certifies your achievement. And you stand to win a valuable prize.

Are you ready to accept the challenge?

Elite is available on both disc and cassette for the BBC Micro and on cassette for the Acorn Electron.

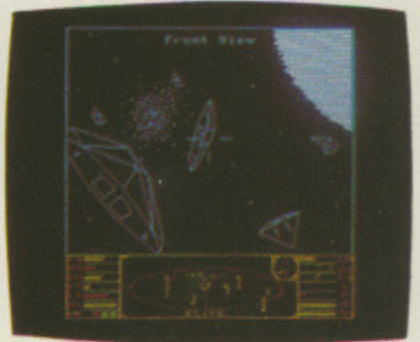

With either, you will get "Elite: The Dark Wheel," a compelling novel which sets the whole mood of your adventure. You'll also get a flight training manual which will get you fit to roar into the unknown in your Cobra spacecraft.

Your Acornsoft dealer now has the entire package at £14.95 on cassette, or £17.65 on disc (for the BBC Micro) and £12.95 for the Electron. (For the address of your local stockist, call 01-200 0200.) Credit card holders can simply telephone 0933 79300 during office hours.

Alternatively, you can order by post from: Acornsoft, c/o Vector Marketing, Denington Estate, Wellingborough, Northants NN8 2RL.

You can also get a free Elite poster by ringing 0933 79300.



ACORN SOFT

E-NET

EDUCATIONAL NETWORKING FOR THE BBC MICRO



Already proven in a number of UK educational establishments, E-Net is a unique breakthrough in Educational Networking. Utilising the Amcom hard disc system in conjunction with the Amcom File Server, E-Net allows the user to network up to 250 BBC micro's with a choice of hard disc capacity from 5 — 280 megabytes, this combination also provides considerably faster access times than conventional floppy disc based systems. E-Net overcomes many of the problems of disc space usage evident in current networking systems, E-Net will monitor the individual pupils use of disc space and also allow the teacher to allocate varying amounts of disc space to individual users by simple commands from the file server, in addition E-Net will allow full implementation of multi-user random access files.

E-Net is secure because each authorised user is allocated a user number and password unique to that user. Upon switch-on of a client machine, that machine prompts the user to insert their number and password and only at this stage may the user gain access to his programs. For added security, the user number and password are invisible on the screen. E-Net is flexible, at all times the file server has complete control over the client machines and, for example, can force a specific program to one or more machines, can view a particular client machine screen at anytime, and can directly access client machines and display screen messages without interfering with normal operation.

Important files can be easily copied from the hard disc to floppies and one or more printers may be used with E-Net,

as these are controlled directly by the file server, this means that the micro's to which the printers are connected are available for normal use whilst the printers are working.

E-Net is a flexible, simple to use yet comprehensive networking system and is available now from Pace. To find out how E-Net can benefit you please telephone for a full specification fact sheet, or to attend a demonstration.

PACE

PACE SOFTWARE LTD.
92 NEW CROSS STREET,
BRADFORD BD5 8BS.
Tel. (0274) 729306 Telex 51564

'Q
ha
ed
Q

A MA
being
North
that th
hand-l
and lea
the B
signific
child
ability.

Fund
Newcas
£20,00
school
teacher
and 23
The

THE
most re
the ma
findin
independ
trol ex
pleted.

It r
failure
machin
I per c
The
ioned
prises,

Z80 cost soars £100, but disc drive drops £50

IN a surprise move Acorn has put up the price of the Z80 Second Processor by a swingeing £100. But it has reduced the prices of its 100k disc drive by £50. The single disc drive now costs £199 and the Second Processor £399.

The Z80 price has been increased to enable dealers to offer better support to their customers.

Tom Hohenberg, Acorn's marketing manager, said: "The Acorn Z80 is a complex product with sophisticated bundled software, and customer support is an essential part of the Z80 package."

Stretched

"High demand for the product has stretched the resources of our dealers, so we have decided to provide a larger margin to enable them to expand and improve their customer support services."

"We believe most intending Z80 buyers will still find the product extremely cost-effective."

"The price increase is small compared with the cost of a complete business system, and more than compensated for by our recent £105 drop in the price of the dual disc drive, part of a complete Z80-based system".

CARRYING THE TORCH

ACORN Computers sales director Peter O'Keeffe has been appointed chief executive of Torch Computers in place of Bob Gilkes, who has resigned as chairman and managing director to take up other interests in the computer industry.

Peter O'Keeffe, 40, will be on secondment from Acorn at the invitation of Torch's major shareholder Newmarket (Venture Capital) Ltd.

In May Acorn signed heads of agreement for the acquisition of Torch, and takeover negotiations are now well advanced.

'Quinkey
has the
edge on
Qwerty'

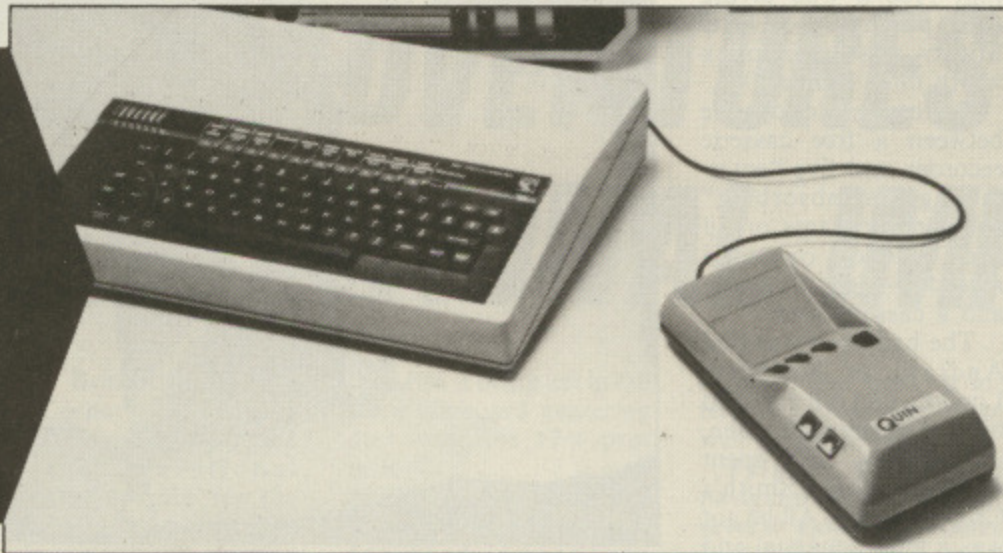

BBC MICRO IN MAJOR SCHOOLS STUDY

A MAJOR study is being launched in the North East into claims that the Quinkey – the hand-held keyboard and learning device for the BBC Micro – significantly improves children's writing ability.

Funded by the city of Newcastle at a cost of £20,000, it will involve 14 schools, more than 30 teachers, 1,000 pupils – and 23 BBC Micros.

The project will

examine numerous provisional claims being made by teachers who have given children – as young as six – the opportunity to use text handling facilities.

It will also look into suggestions that:

- Pupils tend to write more.
- Concentration improves in class.

- Children take a more critical attitude to what they write.

- Punctuation and spelling gets better.

- Even the students' handwriting improves.

Mike Clark, deputy head of the city's Heaton Manor School and project leader, says:

"There is now general agreement that giving

pupils access to text handling facilities does seem to improve their whole attitude towards the written word".

Now Mike Clark's team will attempt to establish how valid these initial assessments are. And if they prove to be correct, just what is needed to maintain and extend the benefits?

Although the educationalists readily admit that most Word Processing programs might be expected to bring such results, he believes that Quinkey has three significant advantages.

"Using the program QUADI – which comes as part of the educational package – four pupils can use a BBC Micro simultaneously for text handling, working on their own individual texts up to 72 lines long", he said.

"Their work can be stored on cassette or disc or printed out as required."

Turn to Page 24

Beeb is Mr Reliability

THE BBC Micro is the most reliable computer on the market. That is the finding of a major independent quality control exercise just completed.

It reveals that the failure rate for the BBC machine is currently only 1 per cent.

The survey, commissioned by BBC Enterprises, was carried out by

Daisley Associates, an independent testing house. They report there has been a "dramatic improvement" in Acorn's quality control since the project was launched several months ago.

However, neither Daisley Associates nor BBC Enterprises were prepared to provide *The Micro User* with further information about the tests

prior to going to press.

Instead they were busy making arrangements for a press and TV open day at the quality control test centre to announce the news with all due fanfare.

Meanwhile, over at Acorn yet another spokesman refused to discuss the subject of quality control. But he did admit that the 1 per cent failure figure "sounded right".

Schools study

From Page 23

This simultaneous access – for less than half the cost of a computer – improves the cost effectiveness of the expensive micro equipment. It also makes classroom management easier.

“Using another program (PROG) which also comes as part of the total package, it ought to be possible for up to four pupils to have access to almost any program which runs on the BBC using less than 30k of memory.

“No longer is it necessary to share the single Qwerty keyboard of the computer. Pupils can each use their Quinkey pad to assess the program”.

Potential

Mr Clark said Newcastle will be systematically field testing a considerable number of programs – commercial programs, MEP material and the work of local teachers – to explore the potential of this kind of cooperative use of the micro in talk, planning and joint activity.

“It seems possible that the Quinkey keyboard, with only six keys and its way of relating key patterns to letters, makes use of learning strategies and potential which are currently under-valued in education”, he said.

“Certainly pupils seem to memorise the Quinkey keyboard much more rapidly than Qwerty, and to reach handwriting speed more quickly too.

Significant

“More particularly, pupils of widely differing ages with learning difficulties of various kinds relating to reading and writing seem to find Quinkey a significant aid in breaking through the learning barrier”.

However, the small group of teachers and advisers so far involved in this work realise that such findings which appear so important need to be explored far more rigorously.

Consequently the project has been established which will involve eight primary schools, three first schools, one middle school and two secondary schools.

Why Andy missed out in starter pack offer

THERE was good news and bad news for regular reader Andrew Healey in the August issue of *The Micro User*.

The good news was that Acorn was giving every purchaser of a BBC Micro a starter pack worth more than £80.

Buyers could choose between a free cassette recorder and five “entertaining and absorbing” software programs, or – if they already owned a recorder – eight programs and a cassette lead.

The bad news was that Andrew, of Norbury, London, had not received his free starter pack when, in mid-July, he'd spent £399 at W.H. Smith's Croydon store. All he got was a micro, manual and welcome cassette.

“Where is my free starter pack?” the 20-year-old student wanted to know.

“I'm sorry, we don't know anything about this offer”, he was told when he went back to the shop.

So Andrew wrote to Acorn.

Jennifer Hyde of the company's customer service department wrote back to confirm that Acorn were indeed funding a summer promotion involving giving away free



Andrew Healey... good news from W.H. Smith

starter packs.

But, unfortunately for Andrew, W.H. Smith “chose not to take part in it”.

Undaunted, he then wrote to *The Micro User* to ask if we could help him get his free starter pack. Our articles had, after all, stated that “every purchaser” of a BBC Micro would get one.

Could *The Micro User* have got it all horribly wrong?

“No, it was our fault”, confessed Robert Blood of The Quentin Bell Organisation, Acorn's PR agency.

“We sent out a misleading press release. We should have said the offer applied only to those stores electing to take part in the promotion – and we should have listed their names.

“On Acorn's behalf we'd like to apologise to anyone who was misled

into thinking they would get the free starter pack at W.H. Smiths and other similar outlets”.

So why didn't W.H. Smith take part? John Rowland, the firm's personal computer merchandise controller says they weren't really able to.

“With 70 outlets selling Acorn products we are one of their biggest customers and of course we buy in bulk and organise our stock situation well in advance.

“This Acorn promotion was really only viable for small outlets flexible enough to take on two or three extra micros in order to take advantage of the free pack offer”.

Andrew Healey still feels there is a principle involved and, claiming that “every purchaser of a BBC Micro” applies as equally to him as anyone else, has written to Acorn managing director Christopher Curry requesting his free starter pack.

By press time Andrew was still waiting for a reply.

However, he can take consolation from the £50 software voucher W.H. Smith has sent to him as a customer relations gesture after *The Micro User* told of Andrew's disappointment.

Acorn package aims at doctors

A DOCTOR'S system based on the BBC Micro that helps GPs run their surgeries marks Acorn Computer's first direct move into Britain's “potentially lucrative medical market”.

The package, which includes specially written software and an entire disc-based BBC Micro system, contains everything GPs need to automate at a reasonable cost many essential yet time-consuming practice tasks, such as repeat prescribing and

patients' record-keeping.

Acorn estimates that of some 8,000 practices in Britain less than 5 per cent use computers.

The package contains the first part of a suite of programs designed for GP practice.

Additional programs under development will handle tasks such as

drug usage statistics, an age/sex register for automatic recall of patients and financial administration.

Acorn is also developing total packages for dentists and opticians.

The Acorn Doctors Package was developed by two practising GPs and costs £1,999.

MINI OFFICE HAS MAXI RANGE

A BUSINESS package with a revolutionary pricing policy which it claims will at last enable the BBC Micro to become an inexpensive office tool has been launched by *The Micro User*.

Mini Office, a professionally written word processor, database, spreadsheet and graphics package for the BBC Micro and Electron machines costs £5.95 on tape and £7.95 on disc.

"We are aiming at one man firms across the country who simply cannot afford to pay for the business software currently on the market with price tags of hundreds of pounds", says Derek Meakin, joint managing director of Database Publications.

"It will also be well in the price range of housewives who wish to use it for correspondence or domestic book-keeping - or even for children wanting to monitor their pocket money".

Mini Office has been written as a serious introduction to using a home computer in a working environment. And it comes complete with a free 32 page easy-to-use operating guide.

LOGO CHOICE ON ITS WAY

GOOD news for BBC Micro users who have been waiting patiently for Logo.

Logotron has commissioned a full implementation of the international programming language for the micro from Logo Computer Systems

And Acorn is planning to bring out its own version of Logo.

Logotron's Logo will be supplied on a single ROM and will be fully



Simulations for the latest educational adventure programs from the BBC are based on actual photographs.

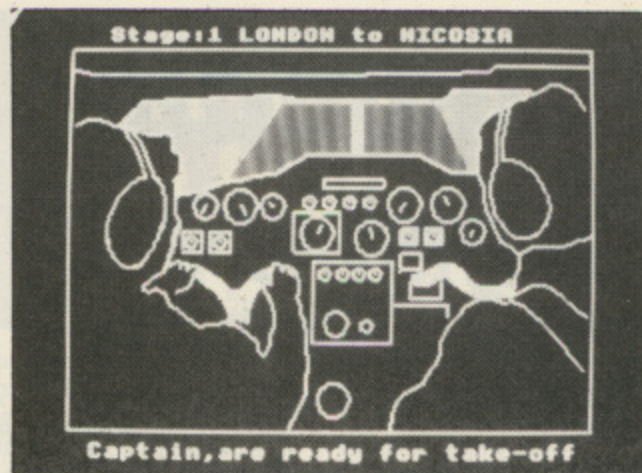

BBC ADVENTURES HAVE EDUCATIONAL IMPACT

THE British Broadcasting Corporation is poised to carve itself a larger slice of the educational software market for the BBC Micro.

It is currently running an in-depth survey to identify all available software in order to pinpoint the areas in which it can make the most impact.

"We have reached the stage where the BBC Micro is firmly established in schools", Stefan Nowak, the BBC's software education officer told *The Micro User*.

"Now we need to consolidate its position by putting some good software out. This will ensure the micro becomes an essential part of the school curriculum, rather

than risk it being left in the store cupboard gathering dust with the film projector".

The BBC intends to concentrate on well scripted adventure programs as educational vehicles.

And it believes it can successfully increase its market share by exploiting its advantage in the area of school broadcasts - marketing software directly linked to series.

As part of this policy, the corporation has announced that it will shortly release software to accompany four broadcasts in the Introducing Geography Series for 10 to 12 year olds.

"Our aim is to help children acquire a geographer's 'eye' on the subject and in particular the geographer's use of vocabulary", explained producer Mike Howarth.

"Simulations planned use some of the familiar computer games techniques, but only so far as they involve a goal with rewards and penalties.

"However the random element is replaced by a carefully structured but absorbing journey to a successful or sticky end".

The software titles are:

River: A plane crashes on a mountain range. The survivor's map only shows the contour lines of the region. Following the map ensures a successful escape. Children find out the landscape features at each stage of the river, the problems rivers can pose

to man, and need to interpret a cross section as well as the contours.

Flight: Pilot and navigator choose one of several global air routes including refueling stops, given out by the computer. Using atlases, players fill in their flight logs with names of countries, towns, rivers and mountains in order on each leg of the flight.

Summit: Players have to supply stores to each camp during an expedition to climb the South West face of Everest, so enabling the team to

struggle to the top.

Nomad: Players experience the hardship of the Fulani, a race of nomads whose cattle graze the Savanna of West Africa. Using rainfall charts, it is necessary to keep the cattle alive by moving them to areas where they are likely to find water.

"With programs like these, we can make lessons come alive and so emphasise the importance of the BBC Micro", says Stefan Nowak. "And, at one and the same time, increase our market share".



NOW that more and more factory machines are computer controlled, there is a big demand for training.

Pictured here is the Starturn, from Denford Machine Tools, which links a mini-lathe to a BBC Micro.

Developed for classroom work in schools, colleges and training centres, Starturn is claimed to teach all the skills needed for operating

full-size production lathes.

Software controls feature circular interpolation and screw cutting with specified pitch in inches or metric. Programming can be inch or metric, absolute or incremental.

High resolution for toolpath graphics, for program verification, can be produced on the micro. Programs can be dumped to a printer.

Broadmoor patients go for computers

PATIENTS at Broadmoor – the hospital for the criminally insane – are taking part in computer classes using the BBC Micro.

The news leaked out when an inmate mailed a computer game he had written to the offices of *The Micro User*.

“Yes, we do have computer classes using the BBC Micro”, admitted a spokesman for the high security psychiatric hospital, which houses 550 patients.

“They are part of our

education department here”.

In fact the level of interest in the BBC Micro at Broadmoor is so high that a number of patients have now bought their own machines.

One of them – who cannot otherwise be identified – was the computer programmer inmate who devised the fruit machine game which duly arrived at *The Micro User*.

“He’s in fact our star computer student”, confided the hospital spokesman.

“It probably stems from the fact that we’ve had a very active colour television repair shop here for a number of years”, he said.

“Naturally that will have created the interest in electronics. So from there it’s only a small step to computers”.

Just who is taking part in the computer classes at Broadmoor is a strictly classified area. However *The Micro User* was able to learn that the hospital’s most famous current inmate – Ronnie Kray – has not sought hands on experience of the BBC Micro.

“I don’t really think that sort of thing interests him”, said the spokesman.

Forth takes priority

SKYWAVE Software now has a 16k eeprom that enables the BBC Micro to run programs written in Forth.

It sits in the sideways ROM area and can be placed so as to have a higher priority than Basic so that the micro comes on in Forth instead of Basic.

The version of the language – Multi-Forth 83 – gives a multi-tasking capability. So the user can have a number of Forth programs executing at the same time.

Limited

Each task is placed in a queue and up to 28 at once are possible. The number of tasks the system can run is limited only by available memory.

The system comes with four pages (1k) available for tasks. This can be expanded as required.

However Skywave says it is finding it hard to get the eeproms, so postal buyers should check availability by phone.

Micros from Dublin

ACORN’S Irish distributor, Lendac Data Systems, is putting £500,000 into a new Dublin factory to make BBC Micros under licence.

Production starts straight away, and 5,000 units are planned for the first year of operation.

Acorn has just opened a Dublin office, and will combine with Lendac in a marketing thrust into consumer, educational and business markets.

Lendac, set up in 1979 by two computer graduates of Trinity College, Dublin, is sole Irish distributor for Acorn.

Aware

Acorn’s Chris Curry said: “Irish schools are becoming increasingly aware of the value of computers, and we expect the educationally-proven BBC Micro to win a substantial share of this business”.

Heading Acorn’s Irish office is Niall Andrews, formerly with Philips Data Systems in Ireland, who said: “The Irish market is developing rapidly – up to 35,000 home micros for 1984 and probably double that in two years.”

“We are confident that Acorn can capture at least 50 per cent of the ‘BBC Micro type’ market, and over 20 per cent of all home computer sales before 1986”.

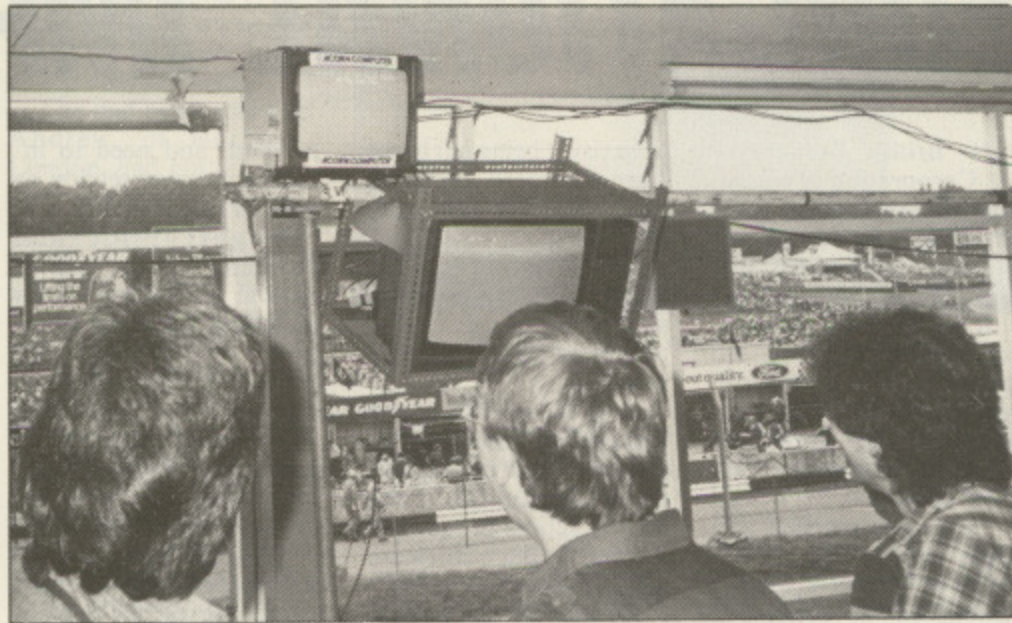

BBC Micro a winner at Brands Hatch

WHILE Brands Hatch was playing host to the largest crowd at a British sporting event in recent times – 124,000 people saw the British Grand Prix there – computer history was being made behind the scenes.

For the first time ever at a Formula One racing event a networked micro information system was used to flash information from the pits to the press, officials and motor sport VIPs.

The Acorn designed system involved a BBC Micro positioned in the pit area as a sender unit. Information was networked via Econet to a number of strategically positioned monitors in the large central marquee and the 190 seat press viewing

area.

The system was a slightly modified version of that used for the first time at the Acorn Computer European Race Day at Silverstone in June, which featured the European Formula Three championship as the main event.

BBC television motor racing commentator Murray Walker, whose booth – shared with James Hunt – was served by one of the network’s monitors, said: “The system proved to be invaluable.”

“I was getting up to the minute information from behind the scenes faster than ever before.”

“During the race we had a television monitor failure and I was unable to

see what was happening on the far side of the circuit. So I used the information coming off the Acorn system to keep viewers in touch”.

Teletext and Prestel pages contained in the system also allowed world news and progress of other sporting events to be displayed around the network.

Acorn enhanced the vast international press facilities at the race by providing BBC Micro word processing systems – along with trained personnel to demonstrate their use.

Journalists could use them to prepare and, if necessary, alter their texts before printing perfect copy for sending to their publications.

German challenge

A DAISY wheel printer to challenge Japanese dominance of the low price end of the market has been produced by West German firm Triumph Adler.

The 20 characters-a-second TRD 7020 is designed for personal computers costing from £200 upwards, but is aimed at any system where the primary application is word processing.

A library of more than 150 interchangeable print wheels provides a choice of type styles which can be printed 10, 12 or 15 characters an inch or with proportional spacing. Underlining and shadow print can be used.

Costing £375, the machine is the result of a DM50 million investment in a new robotised manufacturing and assembly facility – developed with the assistance of TA’s Volkswagen parent.

h
s
rity

Software
eprom that
BBC Micro to
written in

the sideways
and can be
to have a
than Basic
Micro comes
instead of

on of the
Multi-Forth
multi-tasking
the user can
er of Forth
uting at the

ed

placed in a
to 28 at
ossible. The
tasks the
n is limited
available

comes with
) available
is can be
required.

Skywave
g it hard to
so postal
check
phone.

an

enge

eel printer
Japanese
the low
the market
duced by
an firm

characters-
7020 is
personal
ting from
s, but is
y system

ary appli-
processing.
more than
eable print
a choice of
ch can be
2 or 15
inch or
nal spac-
ing and
n be used.

375, the
result of a
vestment
sed manu-
assembly
oped with
of TA's
rent.

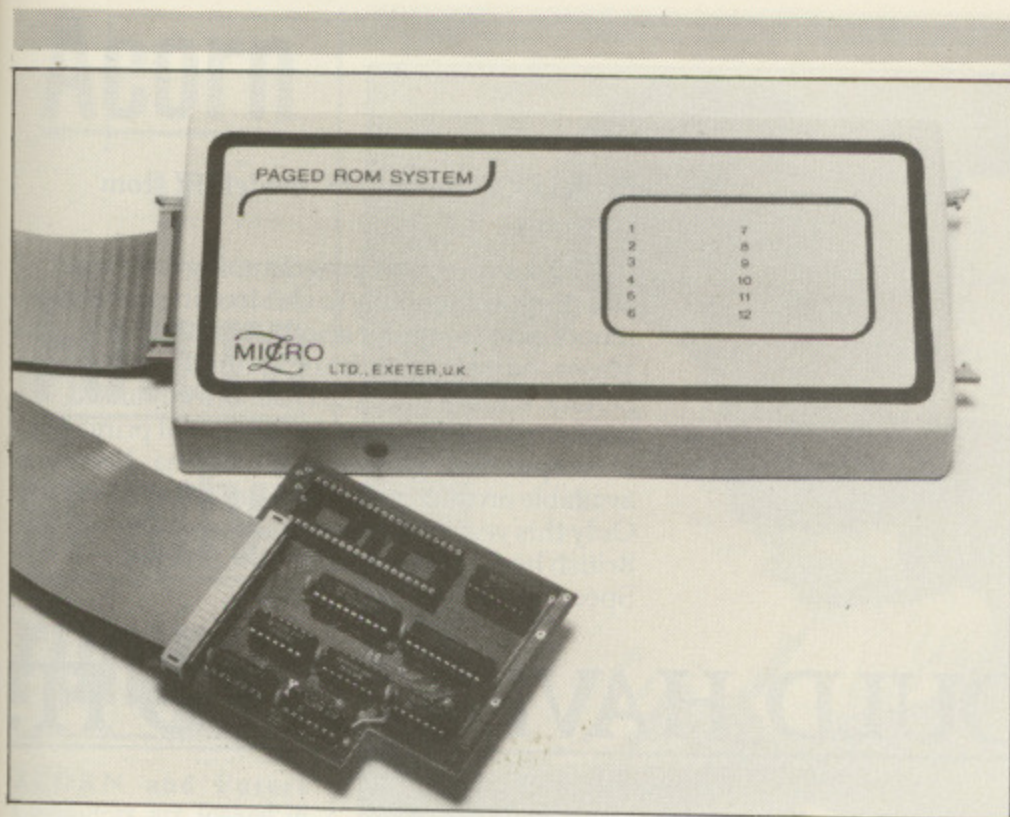

WHAT is claimed to be the first software addressable external sideways ROM extension for the BBC Micro has been launched by Micro-Z.

By developing the external sideways ROM board, the appliance removes the need to continually open up the micro's case when exchanging ROMs.

It can be used either inside or outside the micro.

Two circuit boards are utilised and are common to either internal or external application. In both, the CPU board is

RAM expansion from Micro-Z

mounted internally by plugging into the 6502 socket.

The board is designed to occupy minimum space within the micro and not conflict with any space required for other upgrades such as RAM extensions and double density disc boards.

Installation of the

system does not involve soldering, and particular attention has been given to minimising heat output and power consumption.

Micro-Z plans to release upgrade modules for its system to provide RAM expansion, combined eprom eraser/programmer, and additional ROM expansion units.

Patents row a boon to buyers

A DISPUTE between Aries Computers and two firms it alleges are infringing its expansion board patents has resulted in savings for BBC Micro owners.

The Cambridge based company has slashed the price of its 20k RAM expansion - the Aries-B20 - from £115 to £79.95.

Aries managing director Peter Headland explained: "We had planned a price cut but the bare faced plagiarism of a couple of our competitors accelerated the process.

"We are the sole legitimate licensees of the Aries-B20 patent application. This is being flouted by cheap imitations distinguished by corner-cutting techniques.

"Those concerned seem to believe that changing details of the design removes them from the scope of the patent. In fact they can expect heavy legal action. We intend to press for punitive damages.

"These imitation

Aries-B20s incorporate features such as the use of chips outside manufacturers' tolerances.

"This is going to lead to a lot of unhappy customers with unreliable systems, which ultimately does nobody any good", Headland said.

D-DAY ON THE WAY

A COMPANY which started life nine years ago with a few imported copies of Dungeons and Dragons board games has now started to produce micro games of its own.

Games Workshop, which has built up to a £3½ million annual turnover on adventure and fantasy games, has promised BBC Micro versions of "Battlecars" and "D-Day" for the New Year.

Taking control

A PROGRAMMABLE port control module which connects to the user port of the BBC Micro for experimental computer control has been produced by W.D. Interfaces.

The Portcom contains four single pole change-over relays, each capable of switching up to 3 amps at 28v DC, and two mains outputs, each with a rating of 1200 watts optically coupled.

It features two uncommitted DC outputs controlling voltages up to 50v or currents up to 5 amps with 5v and 12v outputs from the mains derived power supply.

Two 8 LED displays show the status of each output device and each data line of the user port.

The module is available in three versions, £99.95 (cassette), £101.95 (disc) and £115.95 (steel case).

Failed your exam? Then try again

BBC Micro users who failed their O-level and CSE exams will be able to study for their retakes at home, thanks to new software programs launched by Acornsoft/Ivan Berg.

Four revision programs - Maths 1 and 2, English Language and Biology - have been written by teachers for students who are part way through or have completed their appropriate syllabuses.

Each program has up to 150 pages of tutorial, divided into self-contained sections. In English, for example, there are sections on grammar, spelling and comprehension, with on-screen diagrams to illustrate various points.

If a student has dif-

ficulty understanding certain parts of a section he can request an overlay giving explanatory text on the screen.

At any time the student can call up a "jotting pad" at the bottom of the screen to take notes or do sums on a built-in calculator.

After studying each section, the student answers a 10 question revision test. If there is a question he cannot answer he is automatically referred back to the relevant tutorial for further instruction.

When at least 75 per

cent is scored in all sections, the student is ready to attempt the program's mock examination.

This consists of 30 multiple choice questions to be completed within half an hour.

Simulated

Realistic exam conditions are simulated. Any question can be passed if the student is unsure and returned to later. A clock displays time remaining throughout and the program automatically ends when the half hour is up.

The micro then marks

the exam and displays the percentage mark.

The exam is compiled from a database of 100 questions, so it can be taken many times with a different "paper" every time.

The programs have been written by specialists in their fields. The mathematics and English programs were compiled by a group of teachers from University College School in London and the biology program by educational publishing house Hodder and Stoughton.

Each program is available on cassette at £12.65.

A full LOGO for the BBC model "B" from Logotron.

LOGO is a computer programming language, which appeals equally to children in primary school or to computer scientists at the Massachusetts Institute of Technology. Using LOGO, you unconsciously absorb advanced mathematical ideas and fundamental principles of computer programming. LOGO has been available on microcomputers only since 1982. Only this year has it been made available on British home computers like the Sinclair Spectrum and the BBC Micro.

LEONARDO WOULD HAVE LOVED IT!

Leonardo da Vinci would have loved it because LOGO gives full rein to a child's creative imagination, using visual images to convey profound ideas. LOGO could do for computers what perspective did for pictures, bring them alive.

Logotron's LOGO for the BBC "B" was written by LCS1/SOLI, the software house responsible for LOGO implementations for Atari, Apple, IBM, Sinclair, Coleco, and NEC. It's the closest there is to an international LOGO standard, with turtle graphics and full list processing. The software is contained on a single 16k ROM, written in 6502 machine code, fully compatible with the 6502 second processor unit and Econet. Facilities are provided to drive floor turtles, create and use data files, and access routines written in machine language. Full access is provided to the BBC micro's operating system. An optional sprite board, also provided by Logotron, can be used to handle video output and provides more than 30 programmable sprites, allowing true animation.

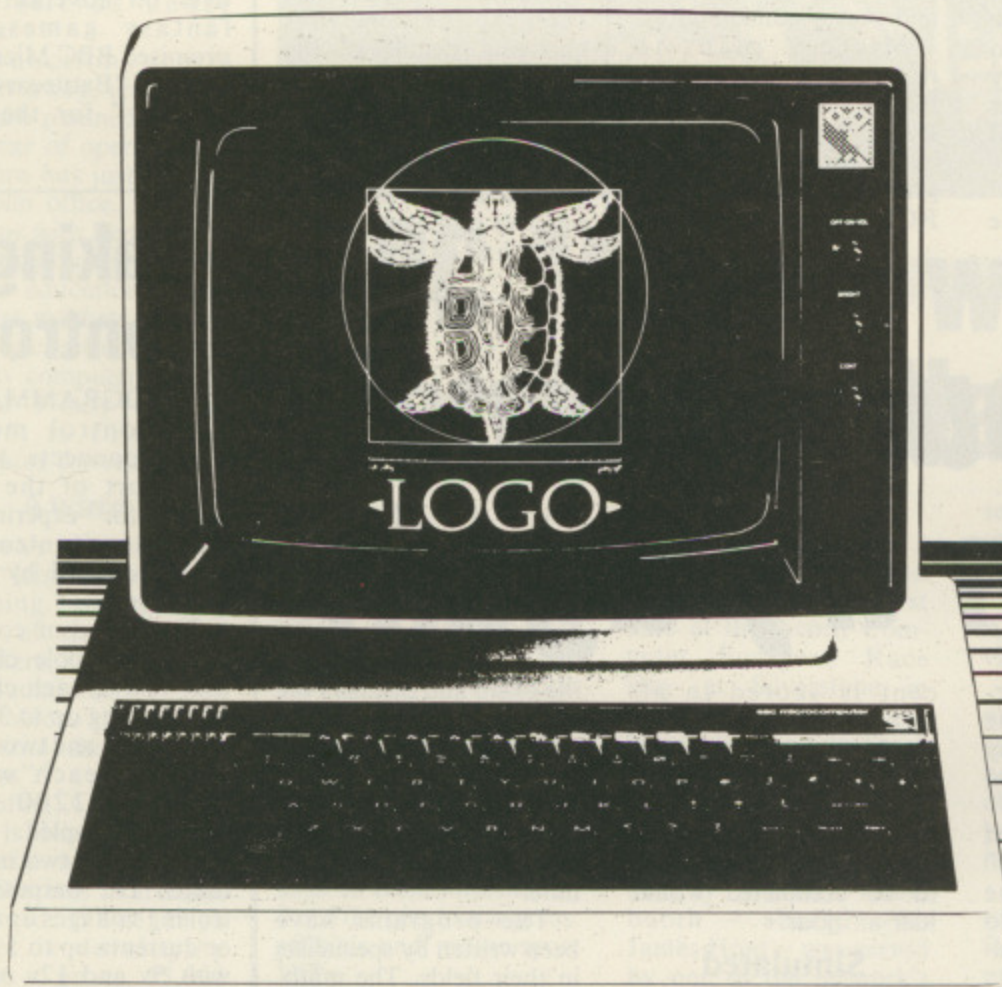

Please send me further information concerning Logotron's LOGO for the BBC Model "B".

NAME

ADDRESS

Educational Establishment;

Home user; Dealer*; Distributor* *attach to company letterhead

If you want to know more about LOGO, send for a descriptive leaflet and price list.

To: Logotron, Dept. MU2, 5 Granby Street, Loughborough, Leicestershire LE11 3DU, England.

LOGOTRON

Acorn

V

Future

in adv't

rumpus

ACORN and Future Computers are locked in battle over the latter's press advertisement claims for its micros.

Acorn has complained to the Advertising Standards Authority because Future Computers has been saying it has "the only micros designed with a built-in networking facility at no extra cost".

Acorn says this is untrue because the BBC Micro is sold in three versions with built-in Econet networking.

Future counters by claiming Acorn's 8 bit machine "is no longer in the running for the demands that modern business places upon it".

Acorn says the BBC Micro is "extensively applied in small and large firms, for whom networking is one of its most attractive features".

An Acorn spokesman said Future's ad claims were "misleading to the public and unfair to the BBC Micro, since Future Computers clearly does not offer the cheapest networking system available".

At press time both companies were still awaiting a ruling from the Advertising Standards Authority.

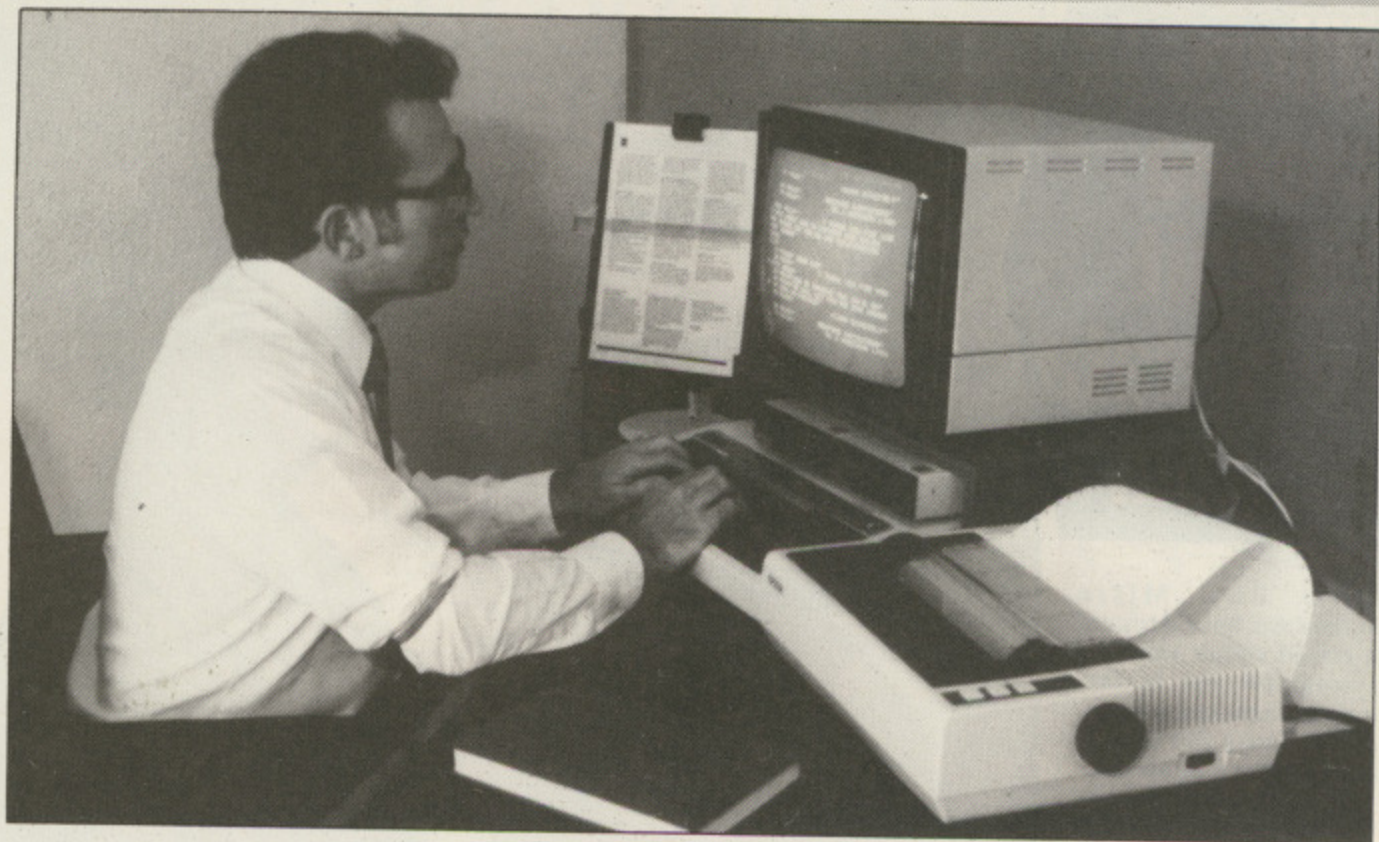

Micro keeps books flowing

A WORD processing system based on the BBC Micro is helping prolific writer Peter C. Smith maintain his annual output of books and major articles.

Smith, author of more than 30 naval histories, ghost stories and novels, decided recently to trade in his old typewriter in favour of the high-tech

approach.

So he asked Bedford Computers to put together a tailor-made word processing system.

The company supplied him with a BBC Micro, twin disc drive system, with sideways RAM, Microvitec RS monitor and Epson RX80 FT. Total cost, £1,700.

"I needed relatively

cheap equipment that was quick and reliable", said the 42-year-old author.

"The company suggested a BBC Micro system, then took the trouble to demonstrate it in use, so I was sure it was exactly what I needed.

"The memory storage capacity and editing facilities mean I can draw facts together and revise

my work as I go along. It is a considerable time saver".

Simon Hodgson of Bedford Computers explained: "Computer packages are OK for most people, but when a client has a specific application we prefer to tailor a cost effective system to fit his specific requirements".

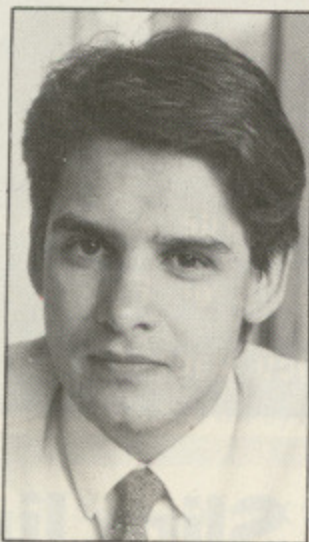

Jeremy Preston

New at Acornsoft

JEREMY Preston has been appointed marketing manager of Acornsoft, responsible for software sales and marketing strategy and the licensing of software on the international market.

Preston, 25, joined Acornsoft from Telcom Gold, British Telecom's electronic mail company, last year as project controller.

He has an honours degree in computing science and a formal computing background in programming and systems work.

BBC English – the Acorn variety, of course

"BRITISH English" – the goal of people from Andorra to Zaire who wish to emulate the sounds and syntax of the United Kingdom – is being made more accessible by a project involving Acorn and the British Council.

English language students in six of the Council's overseas centres are learning on BBC Micros in a pilot project of CALL – computer assisted language learning.

The Council believes the CALL project offers individualised, self-paced learning plus stimulation of group discussion and project work.

Dr Martin Phillips of the Council's English language services department and coordinator of the project, says experience of a limited experiment in Munich, and observation of CALL classes in the UK, tends to confirm this view.

The Council's English teaching centres in Abu Dhabi, Barcelona, Hong Kong, Madrid, Munich and Singapore have been equipped with BBC Micros supplied by Acorn. The Council has already begun commissioning software appropriate to the needs of learners and teachers.

Dr Phillips says there is a shortage of readily

available high quality software, and developments to date have been "uncoordinated and lacking in a coherent framework".

By the end of the first phase of development, the Council hopes to have produced a package of programs exploring a wide range of different activities and teaching points. It is also planning to develop computer based language testing.

Each centre involved in the project will pilot software in its English language classes, feeding back reactions to provide guidance for the improvement and development of new programs.

Micro in closed circuit viewdata system

TWO BBC Micro enthusiasts have designed a closed circuit viewdata system for use in factories, shops and schools. And it looks like becoming a commercial success.

It all started when Mike Chew, quality controller at an electronics factory, combined with a company programmer to devise a closed circuit system modelled on BBC TV's Ceefax.

The idea was to create an electronic notice board in the factory based on a BBC Micro. Using a key pad, workers could call up pages of news about quality control, sports club results, the day's canteen menu, and so on.

The software comes in two parts. One program, on disc, simulates a typical Ceefax display on screen. And a ROM-based editor provides graphics, oversize text and cut and paste, as well as the usual BBC Mode 7 editing.

Interactive

Mike Chew thinks there are all sorts of uses for his idea, and he has set up a company to market it, along with two colleagues.

In use, the system is interactive, with a Viewdata-type menu.

As well as being tried out at the local comprehensive, the scheme is being looked at by a bank.

They are considering putting it into their branches to give information to waiting customers.

The pages would be created at head office and a floppy disc copy sent to each branch.

Minor changes to the information - interest rates, for example - could be made at branch level. Each branch would have its own BBC Micro and monitor.



Read the story, play the game

...that's the invitation that comes with a novel package announced this month by *The Micro User*.

The Magic Sword is an adventure game on cassette specially written for young children. But that's only half the story.

With it comes a 48 page full colour book that recounts all the events leading up to the start of the adventure.

All the elements of a traditional fairy story are there - a handsome prince, a beautiful princess, a white castle with secret passages and mysterious dungeons, dense forests, deep caves - and a crooked house in which lives a wicked witch.

All these are in the game as well, plus colourful animated graphics and lots of exciting sound effects that encourage the child to travel through the countryside and explore the castle to find the princess and release her

from the witch's clutches.

The game is liberally sprinkled with magic objects the child has to find and collect in order to get through to the end of the story.

The text is in double-height characters. And what is a particularly nice touch is the compass which is on the screen throughout the game.

The directions in which moves are permitted are shown on the compass in flashing mode - a very useful aid for someone new to adventure games.

Slim line deal

MICRO users can now buy a 100k Canon slim drive for £99 including its case, cables, utilities disc and manual.

This follows a deal between OEM supplier Alpha Disc and distributor Chase Data, of Woking.

Alpha Disc say they have agreed bulk pur-

chase terms which allow Chase to sell single discs at low margins.

Top end of the range is a Canon 220 slim dual 400k drive, in a case with power supply, utilities disc and manual for £339.

This model also has a 40 or 80 track LED indicator and secondary switching power supply.

A COMPLETE COLOUR MICRO WITH NO HIDDEN EXTRAS FOR AROUND £499.



The title of 'genius' is not bestowed lightly on man or machine: those extraordinary qualities and powers of intellect are rare.

Einstein had them in full measure. And so now does the new micro computer from Tatung, designed and built in Britain and appropriately named - Einstein.

Einstein was created by Tatung, one of the world's leading electronic companies, and given the capacity and the remarkable capabilities to compete with computers costing far more.

Its simplicity of operation will appeal to the first time buyer and to businessmen who don't want to lose staff to expensive and time-consuming training courses. At the same time its operating system is both powerful and sophisticated to satisfy the most advanced requirements.

For those who have outgrown their existing primitive machine, the speed and capacity of the 500K built-in disc drive will make all the difference. And for the small businessman, the ability to store and retrieve all information in seconds will be as important as Einstein's built-in flexibility, which allows the system to grow as the business develops.

BUILT-IN 80K MEMORY

Total memory capacity 80K RAM divided into 64K 'user' memory and 16K for colour graphics production.

BUILT-IN DISC DRIVE
500K 3" compact floppy disc drive. Potential for massive extra storage with a second 500K disc drive internally.

BUILT-IN 16 COLOUR GRAPHICS High resolution graphic animation from 32 sprites (definable shapes), 16 vivid colours.



BUILT-IN EXPANSION PORTS
Connection to both TV and optional colour monitor, most printers and other computers via RS232C interface. Also twin joystick ports, 8 bit user port, exclusive Tatung Pipe.

BUILT-IN FLEXIBILITY
Powerful Crystal BASIC. Multi-lingual plus ability to run CP/M.†
BUILT-IN VERSATILE SOUND
Sound synthesiser facility includes chromatic music with three voices. Substantial speaker with volume control. Provision for speech synthesiser.

Einstein has them all. Feature for feature, it meets the needs of the novice and the experienced operator, both at home and in the office.

Einstein, designed and built in Britain, is a complete colour micro computer with no hidden extras. And for under £500 is sheer genius.

TATUNG
Einstein
SHEER GENIUS: AT WORK, AT HOME.

DIAL 100 AND ASK FOR FREEFONE EINSTEIN FOR YOUR NEAREST STOCKIST.

†CP/M is a trade mark of Digital Research Inc.

The best name in memory is now also the best name on record...

You no doubt know our name for disk drives. We've spent years on research, development and marketing a range of drives second to none. A logical extension for us was to introduce diskettes. Only when we found a 5¼" double density diskette up to our stringent quality control requirements, and at a price that made sense to the end user, were we ready to put our name to it.

This is the result, a diskette of top quality, complete with a plastic protective case for the ten-pack (we also sell them individually!) together with index stickers.

Cumana diskettes are available now, as single or double sided 40 or 80 track, from your local computer dealer. Don't trust it to chance, go for the best name in memory . . .



Cumana Ltd., Pines Trading Estate, Broad Street,
Guildford, Surrey, England, GU3 3BH.
Tel: Guildford (0483) 571666. Telex: 859380.



No
pot
Bu
V
sol
for
no
bu
to
res
any
du
pri
7
tha
pr
an
iss

S
Sy
M
C
H
Te
Te

The last piece to make your BBC business system complete

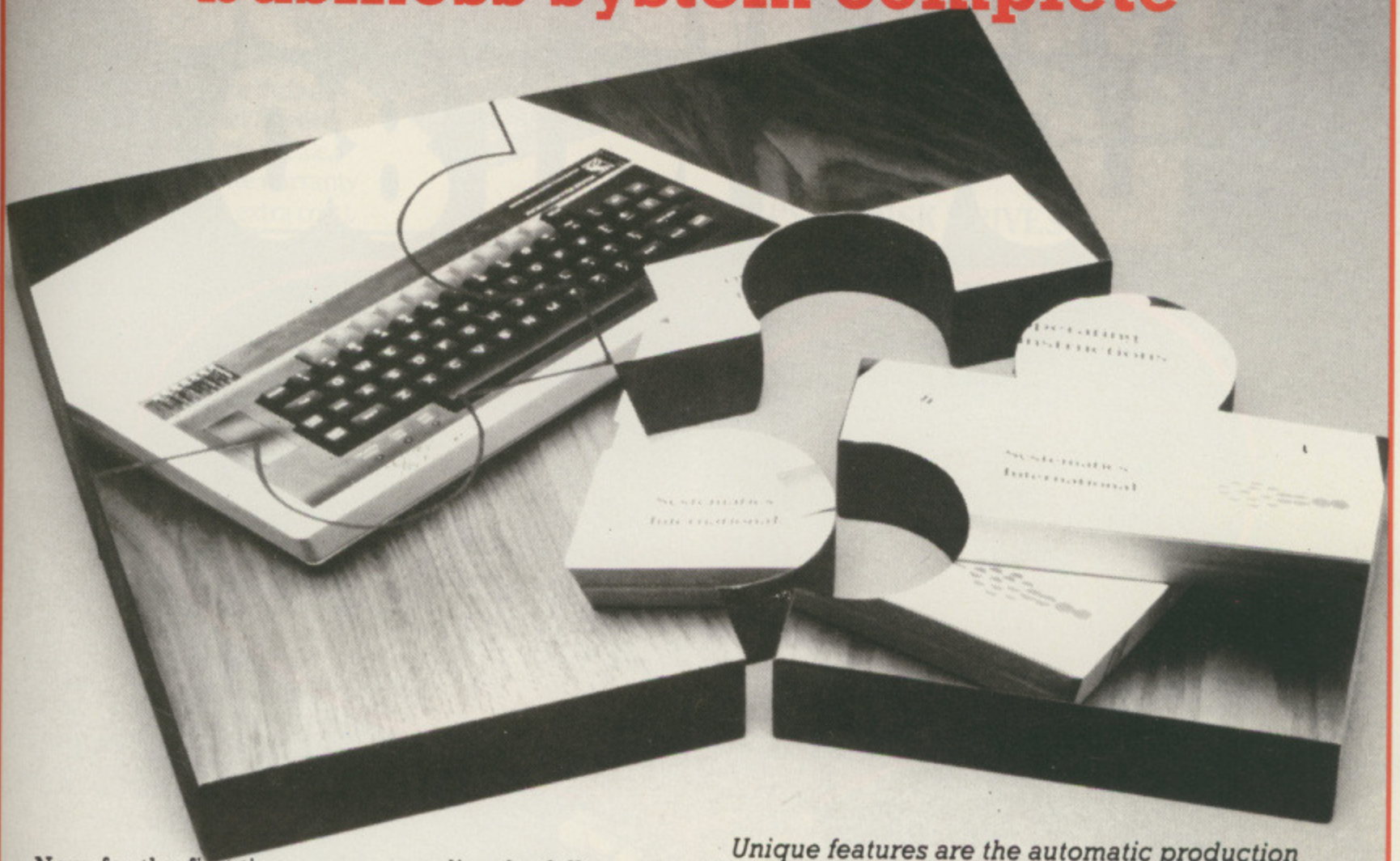

Now, for the first time, you can realise the full potential of your BBC computer as a powerful **Business Management System.**

When developing this new range of business software, our programmers had one objective foremost in their minds - to design 'no nonsense' software for the busy, growing business. We knew that it would have to be easy to understand, efficient, flexible and fast. And the result, a product that will be of immediate value to any small, expanding business - it dramatically reduces the time spent on administration, and presents printed documentation, to the highest standards.

The Sales and Purchase Ledger Duo ensures that you are always in control of cashflow by providing a comprehensive record of ingoings and outgoings, keeping accounts up-to-date and issuing statements and reports on time.

Unique features are the automatic production of V.A.T. statistics for returns and the ability to provide year end accounts for your auditors.

The Stock Control and Invoicing Duo monitors and automatically adjusts stock levels, whilst issuing purchasing recommendations. Invoices are rapidly calculated and immaculately typed.

The unique feature is a free format invoice, which allows non-standard narrations to be used, a most important detail, and previously unavailable.

The two Systematics International Business Duo's are available at only £89.00 each, from selected Systematics International stockists or direct by using the coupon below.

Order with confidence from Systematics International, our reputation as the U.K.'s leading Software House - is your guarantee of satisfaction.

Systematics International



Systematics International
Microsystems Limited,
Cleves House, Hamlet Road,
HAVERHILL, Suffolk CB9 8EE

Telephone: (0440) 61121
Telex: 99431 SIG

Please send me by return the following Systematics International Business Duo's at £89.00 each on TAPE/DISC*

Sales/Purchase Ledger Stock Control/Invoicing

I enclose a Postal Order/Cheque* made payable to Systematics International for £ _____
(add £1.50 towards carriage and insurance) OR

Please charge my Access/Barclaycard/Ammex/Diners* card number

Signature _____

Name: _____

Address: _____

_____ Post code _____ Telephone number _____

Credit card customers may use our 24 hour Telephone ordering service STD. 0440 61121

Orders normally despatched within 48 hours.

Tick this box for a leaflet and the address of your nearest S.I. Duo stockist.

MU/10/84

WHY MICROS LOVE MT80

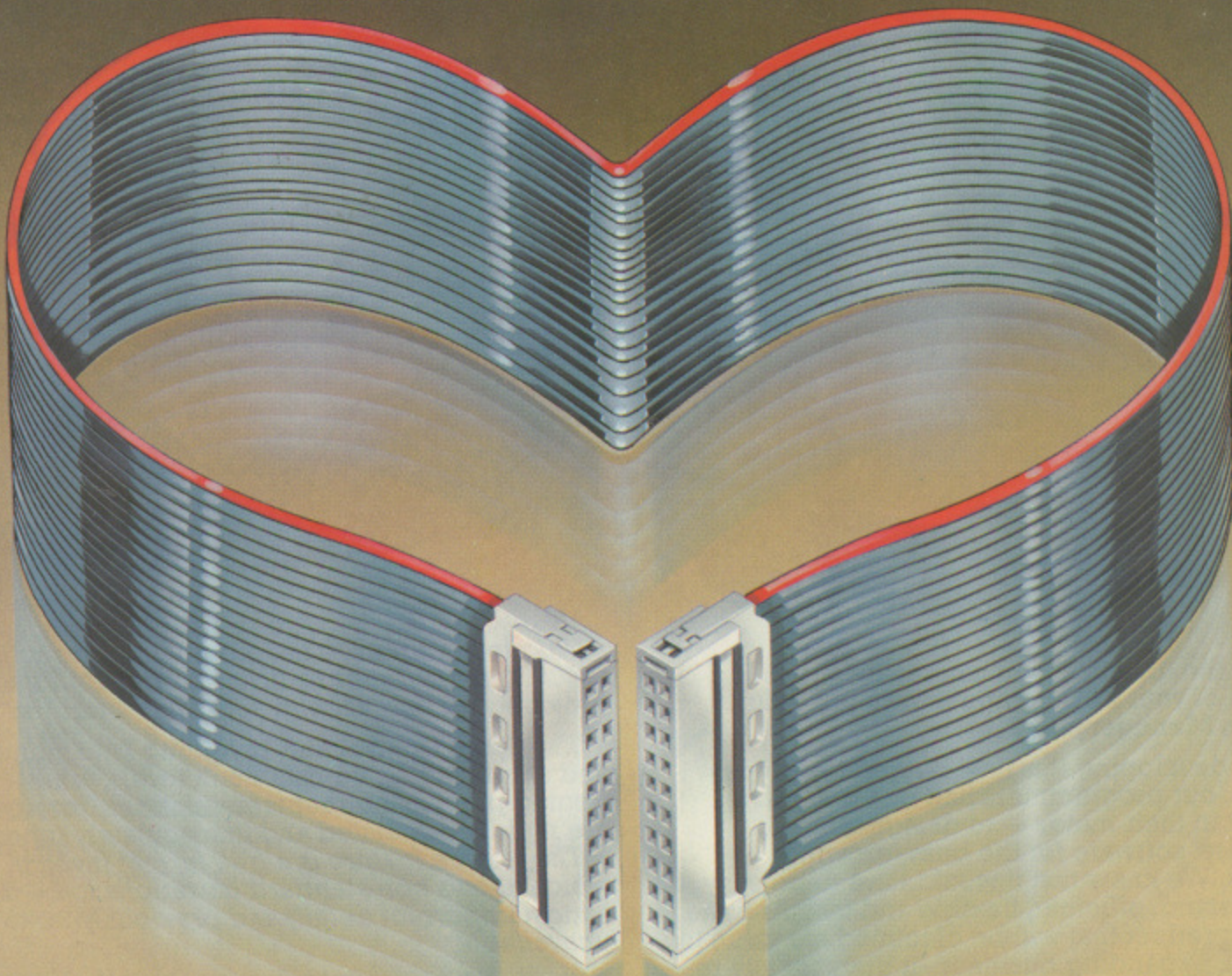

Most leading low cost Micros, eg BBC, Dragon and Sinclair QL love the MT-80 printer from Mannesmann Tally. It is fully hardware compatible and with a range of cable options, gives trouble-free straight through plug-in facilities.

You'll love it too, for its sophisticated looks, and its range of *standard features*, which include 80 col, 80 cps optimised bi-directional printing with dot addressable and line graphs, quick tear-off facility, friction and tractor feed, and easy change cassette ribbon. And all for an ex-VAT price of around £200.

Options include <55dBa sound reduction kit and 2K buffered serial interface.

The dealer who supplies you is supported by Mannesmann Tally, Europe's leading printer manufacturer. Your guarantee of continued support and assistance throughout the life of the printer.



Ask your nearest dealer for a demonstration, or phone us today for full details. Either Annie, Sali, Terry or Geoff will be only too pleased to help you.



MANNESMANN TALLY
THE FIRST NAME IN PRINTING

Mannesmann Tally, Molly Millar's Lane, Wokingham, Berkshire RG11 2QT
Telephone (0734) 791619/791533 Direct Lines or (0734) 788711 Switchboard

SYSTEM

ADVA
IBM cor
2 x 320
Perfect
Perfect
plus 12
(monito

SANY
80% IB
2 x 160
Mailme
Limited
availab
(Monito

ELEC
Include

BBC-
Include
Softwa

PRIN
Brothe
Juki D
Daisys
EPSC
EPSC
Include

OR
Pro

SE
TO
AL
MA

SYSTEMS



ADVANCE 86

IBM compatible, 128K RAM, 2 x 320K Drives. Price includes: Perfect Writer, Perfect Speller, Perfect Filer and Perfect Calc, plus 12 months on site warranty (monitor available at extra cost).

£1437

SANYO 555

80% IBM compatible, 128K RAM, 2 x 160K Drives. Price includes: Wordstar, Mailmerge, Info-Star and Calc-Star. Limited number of SAGE Accounts still available.

(Monitor available at extra cost) £1148



ELECTRON £199

Includes free software tape

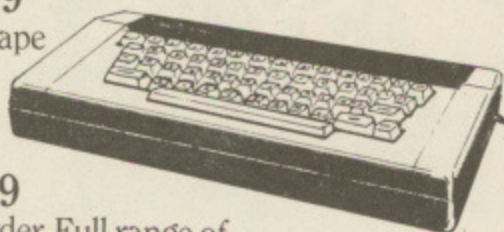

BBC-B £399

Includes free tape recorder. Full range of Software and Disk Drives available.

PRINTERS

Brother Printer HR 15 £399
Juki Daisywheel 6100 £389
Daisystep £295
EPSON RX80 FT £299
EPSON FX80 £389

Including lead for BBC.

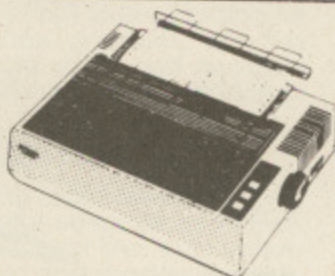

DISKETTES

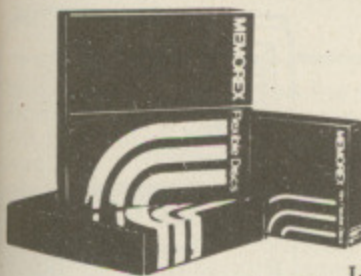

Memorex, in packs of 10
SS 40tk.....£18.00
DS 40tk.....£23.00
SS 80tk.....£26.00
DS 80tk.....£29.00

Including VAT, p&p.

Stay tuned to Microware for further discounts

EPSON DISK DRIVES

200K-400K-800K

plus new 3 1/2" range
(including manual 8 formatter)

100k single unit £139
100k dual unit £229
200k single unit £195
200k dual unit £325

400k single unit £225
400k dual unit £349
Switchable £375

UDM DDFS £95

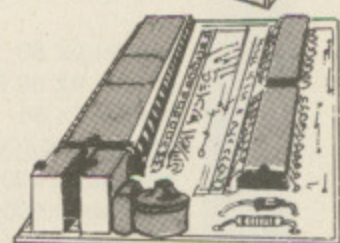
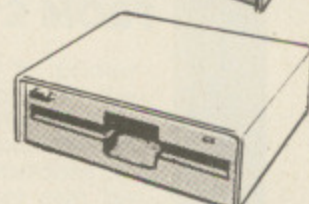
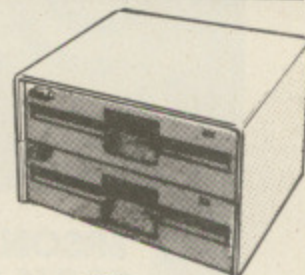

MONITORS

Microvitec colour
Normal res. £199
Medium res. £299
High res. £399
Sanyo/BMC 12" C £110

Call for our full price list.

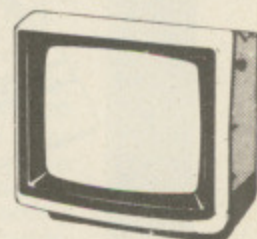

ACCESSORIES

BBC Stands.....£15.00
Dust covers.....£5.60
(for BBC Drives and Printers)

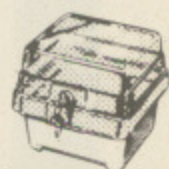

Disk storage boxes.....
£17.00 (takes 35)
Disk storage boxes.....
£25.00 (takes 80)
Prices include VAT, p&p.

ORDER FORM

Product	Price	Qty.	Total
_____	_____	_____	£ _____
_____	_____	_____	£ _____
_____	_____	_____	£ _____
_____	_____	_____	£ _____
_____	_____	_____	£ _____
_____	_____	_____	£ _____
_____	_____	_____	£ _____
_____	_____	_____	£ _____

SEND DETAILS ON _____

TOTAL SUM ENCLOSED (Cheque or credit card no.) £ _____
ALL PRODUCTS ARE BRAND NEW, BOXED AND OFFERED WITH FULL MANUFACTURERS WARRANTY. All prices include VAT & delivery

MICROWARE

14 Charles Street Hanley Stoke-on-Trent
(0782) 269 883
67 Westow St. Upper Norwood London SE19
01-771 5123
637 Holloway Road London N19 5SS
01-272 6398

I enclose my order for the above products.

Name _____

Address _____

Signed _____

SCILLUK

EPSON LOW PRICE SPECIALS FROM £199.00

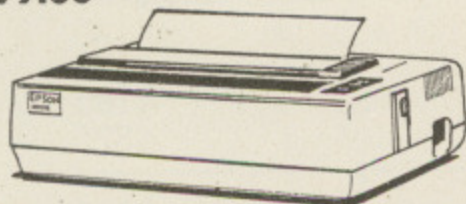

EPSON RX 80	100 cps	£249	£199.00
EPSON RX 80 FT	100 cps	£285	£229.00
EPSON FX 80	160 cps	£438	£324.00 PLUS
EPSON MX 100	100 cps	£475	£369.00 VAT
EPSON RX 100	100 cps	£450	£385.00
EPSON FX 100	160 cps	£569	£499.00

JUKI 6100 — ~~£399~~ **£349.00** + VAT

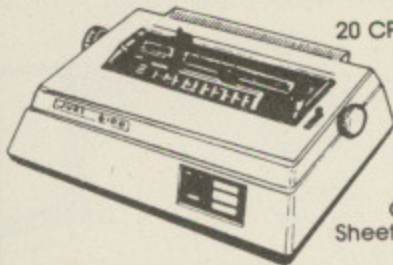

20 CPS: Bidirectional & Logic 10, 12, 15 & Proportional Spacing; Wordstar compatible; 2K Buffer; 13 inch Platen; Underline; backspace & lots more; Centronics Interface Standard. Optional RS232, Tractor and Sheet Feeder

SHINWA CP80 — ~~£299~~ **£179.00** + VAT

Friction and tractor feed as standard. 80cps. Bi-directional logic seeking 13 x 9 dot matrix giving true descenders, sub and superscripts. Italic printing and auto underlining. Condensed, emphasised, expanded and double strike (can be mixed in a line). Parallel interface fitted as standard.



ADMATE DP80 — ~~£229~~ **£169.00** + VAT

The Admate DP-80 has a large range of features and a low price. Ideal for the first time user. 80 cps; 80 column; Bi-directional logic seeking; block and dot addressable graphics; sub/superscript, auto underline, condensed, emphasised, expanded and italic print.

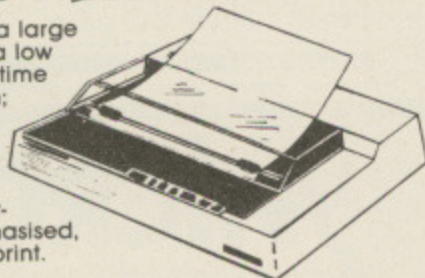

QUEN DATA — ~~£299~~ **£199.00** + VAT

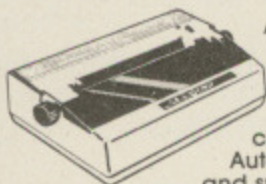

A wonderful opportunity to purchase a daisy wheel printer at a price you can afford! Features include: 16CPS; Bi-directional; Logic seeking; Proportional spacing; WordStar compatible; 13" platen — 12" print line; Autoscore; Bold and shadow printing; Sub and superscripts; QUME compatible ribbons; QUME compatible daisywheels; 4 level impression control; Prints original + 4 copies; Low noise.



CANON PW1080A
THE NEW NEAR-LETTER
QUALITY MARVEL!

£289
+ VAT

APPLE TAUGHT MACINTOSH ABOUT MAN. NOW MAN WANTS MACINTOSH.

Introducing Macintosh. Macintosh's brain is the same blindingly-fast 32 bit MC68000 micro-processor that powers the Lisa personal computer.



Its heart is the same Lisa technology of windows, pull-down menus, mouse commands 32-bit power more useful by making Macintosh far easier to use.

Now for some small talk

If the problem won't come to Macintosh, you can always take Macintosh to the problem — it weighs 9 pounds less than the most popular portable computer.

Just pick Macintosh up by its built-in handle, and carry it. A miracle of miniaturisation is Macintosh's built-in 3½" drive. Its discs store 400K — more than conventional 5¼" floppies.

Programs.

There are already plenty of remarkable programs available to keep Macintosh busy. Like MacPaint a program that, for the first time, lets a personal computer produce virtually any image that the hand can create.

CANON PW1080A
or KAGA
80 cols;
seeking;
quiet — le
user-optic
various
copy pap
KAGA TA
DAISY

high relia

There's m
Microsoft,
with Mac
Macintosh
programs
All the r
On the b
RS422 Ap
printers, r
expensive
with an e
controller
Talking a
Macintosh
of produc



Machinto
MacPaint
Microsoft

**7 DAYS
A WEEK**

*** MACINTOSH AND PRINTER DEMONSTRATIONS
DAILY AT OUR SHOWROOMS ON THE HOUR**

- * SUNDAY OPENING**
- * 24 HOUR DELIVERY SERVICE**
- * COMPREHENSIVE TECHNICAL SUPPORT**

**Phone for a Quote
0730-68521
Anytime**



**CANON
PW1080A**

or KAGA TAXAN 810 — £329 £289.00 + VAT

80 cols; High speed printing, 160 cps; bi-directional logic seeking; fantastic 27 cps near letter quality; 23 x 18 matrix; very quiet — less than 60 Db; 4, 5, 6, 8, 10, 12, 17 cpi; down loading for user-optional characters; high resolution graphics; handles various forms, roll paper, fan fold, single sheet and multipart copy paper. Also available — wide bodied Canon PW1156A or KAGA TAXAN KP910 — New low prices!

DAISY STEP 2000 — £299 £249.00 + VAT

18 cps; Bi-directional logic seeking; 10, 12, 15 cps; Wordstar compatible; 13 inch platen; 12 inch print line; auto underscore; bold and shadow printing;

subscripts and superscripts; Qume compatible daisy wheel; optional tractor and sheet feeder;

optional RS232C serial interface; low noise; low cost; high reliability.



There's more software on the way from developers like Microsoft, Lotus and Software Publishing to mention a few. And with Macintosh BASIC, Macintosh PASCAL and our own Macintosh Toolbox for writing your own mouse driven programs, you could turn a few bob in your spare time.

All the right connections

On the back of the machine, you'll find built-in RS232 and RS422 Applebus serial communication ports for connecting printers, modems, and other peripherals without adding expensive cards. If you wish to double Macintosh's storage with an external disc drive, you don't have to pay for a disc controller card — that's built in too.

Talking of extras

Macintosh has a built-in polyphonic sound generator capable of producing high-quality speech and music.



Macintosh automatically makes room for illustrations in text. MacPaint — virtually any image the human hand can create. Microsoft's Multiplan for Macintosh.

THE GRAPPLER — £148 £102.00 + VAT

Your Commodore 64 can print like a pro!

The Grappler offers a complete answer to printer interfacing, with many capabilities unique in the Commodore market place. Complete signal transmission allows many popular name brand printers to operate perfectly with the Commodore 64. Even Commodore's graphic character set can be reproduced on Epson, Star, Oki, Brother.

Prowriter and other popular printers.

Prints screen graphics without software.

Graphics screen dump routines include rotated, inversed, enhanced, and double sized graphics.

Complete emulation of the 1525 printer for printing Commodores special characters.

Text screen dump and formatting commands.

22 unique text and graphics commands.

CANON PJ 1080A — £459 £399.00

+ VAT

Seven colour printer ideal for the BBC, Sirius, Apple, etc. Seven colours print on demand ink jet printer; 70 cps bi-directional; high resolution graphics; will print on acetate sheets for overhead projection; long life ink cartridges 3.5 million characters per cartridge; eight bit parallel interface; Epson compatible; easily replaced colour cartridges; accepts single sheets; interchangeable character sets.



24 hour nationwide delivery by Securicor £9.50 + VAT Bankers orders; Building Society Cheques; Postal Orders; same day despatch. All orders covered by the Mail Order Protection Scheme.

**MANY MORE
PRINTERS AVAILABLE
1,000s OF BARGAINS
— SEND NOW FOR
THE FAMOUS SCI
(UK) CATALOGUE**



**FAST Mail Order
SCI (UK) Unit 16, Inmans Lane, Sheet,
Petersfield, Hants GU32 2AN**

**Freepost Mail Order
SCI (UK) Freepost, Petersfield,
Hants GU32 2BR.
Tel. 0730 68521.**

Telex 88626 MYNEWS G

**PERSONAL CALLERS WELCOME
AT OUR MAGNIFICENT NEW
SHOWROOMS AT
12 High Street, Petersfield,
Hants GU32 2JG.**

We wish to acknowledge the several well known trade marks used in this advertisement

**URGENT
ORDER**

SCI (UK) FREE POST,
PETERSFIELD, HANTS GU 32 2BR.

PLEASE RUSH ME _____

Name _____

Address _____

Credit Card _____

Number _____



Watford Electronics

Dept. BBC, CARDIFF ROAD, WATFORD, HERTS. ENGLAND.

Tel: Watford (0923) 40588/37774 Telex: 8956095 WAELEC

ACCESS ORDERS Tel: (0923) 50234



SPECIAL OFFER

BBC Micro (Model B) New Low Price Only: £326

Price includes a **FREE** Data Recorder PLUS five software programs worth £80. (At Watford we give you a great deal for your money)

6502 2nd PROCESSOR **£175**
Z80 2nd PROCESSOR **£262**

TORCH Z80 DISC Pack **£695**
TORCH Z80 2nd Processor **ONLY £295**

BBC Micro with ECONET **£375**
ECONET Upgrade Kit **£55**
File Server Level 1 **£85**
File Server Level 2 **£215**
Printer Server EPROM **£41**
Clock Terminators (1 pair) **£95**
10 Station Lead Set **£25**
ECONET User Guide and Cable **£10**

Dust Cover for BBC Micro

Protects your expensive Micro from foreign bodies while not in use. **£3.50**

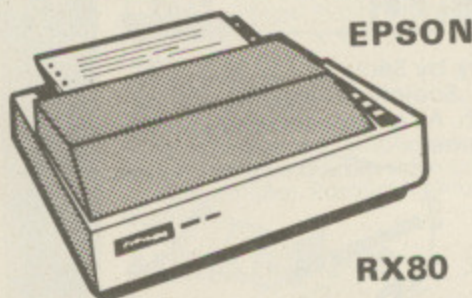

One of the classic printers: 100 CPS, 9 x 9 dot matrix, dot graphics, condensed, double width, normal and italic. 10" carriage; bi-directional logic seek. Centronics parallel interface.

ONLY £229 (£7 carr.)

EPSON RX80 F/T PRINTER

As above but with friction feed capability built in. This allows the use of plain paper sheets.

£245 (£7 carr.)

PRINTER INTERFACE BUFFER

This neatly packaged, self-contained unit is supplied complete with all leads, operating manual and power supply. Computer output to the printer is stored in the buffer so that the computer can continue with other tasks while the printer works from the stored contents in the buffer. 16K holds approximately 10 pages of A4, close to the full memory of Wordwise. The 48K model is very useful for extremely large documents that otherwise tie the computer up for hours while being printed.

Price: 16K **£115**
Price: 48K **£149**

Epson FX80 Printer

The most popular printer in the Epson range. Features include 160CPS, 11 x 9 matrix, proportional spacing, superscripts, subscripts, graphics, many character fonts, user definable character set, margins. Tractor and Friction feed built in as standard. 10" carriage width with bi-directional logic seek for maximum speed. Centronics parallel interface standard.

ONLY £316 (£7 carr.)

Type	Ribbons	Dust Covers
MX80FT	£4.75	£4.50
MX100/FX100	£10.00	£5.25
FX80	£4.75	£4.95
RX80	£4.75	£4.50
GP80	£4.50	-
GP100	£4.95	£3.95
GP250	£5.95	£3.95-
GP700	£18.50	-
KAGA KP810	£5.95	-
CANON PW1080	£5.95	-

RX & FX PRINTER INTERFACES

Epson interfaces fit inside the printer to allow connection using techniques other than Centronics.

RS232	£35	RS232 + 2K Buffer	£59
IEEE 488	£65	2K Parallel	£58

BROTHER HR-15 DAISY-WHEEL PRINTER

This is a high-quality daisy-wheel printer, for the price of a dot matrix. Daisy-wheel quality gives a professional look to your correspondence. Facilities include 18CPS, bi-directional print, 3K Buffer with clear facility, carriage skip movement, text copy switch, proportional spacing, underlining, bold, shadow, super and sub-script, printing in two colours. Impact control allows use of carbon paper. Connects directly to the BBC micro with centronics parallel interface. RS232 interface is an optional extra. Other options are a single sheet feeder that automatically feeds up to 150 single A4 sheets and a keyboard to transform the printer into a sophisticated electronic typewriter.

SPECIAL OFFER ONLY £339 (carr. £7)

Single Sheet Feeder **£195**
Electronics KEYBOARD **£135**
TRACTOR FEED Attachment **£90**

RIBBON CARTRIDGES:
Fabric **£3**; Carbon **£3**; Multistrike **£6**
DAISYWHEELS (various typefaces) **£18**

LISTING PAPER (Plain)

1,000 Sheets 9½" Fanfold Paper	£7
2,000 Sheets 9½" Fanfold Paper	£13
1,000 Sheets 15" Fanfold Paper	£9
Teleprinter Roll (Econo paper)	£4

PRINTER LABELS (On continuous fanfold backing sheet)

1,000 90 x 36mm	£5.50
1,000 90 x 49mm	£7.75
1,000 102 x 36mm	£6.25

Carriage on Printer Paper or Labels **£1.50**

NEW DPW1 120 DAISY WHEEL PRINTER

At last a low cost, high quality daisy wheel printer that everyone can afford, yet there are no compromise in facilities available - 20 CPS, bi directional, logic seeking, print 10, 12 & 15 pitch, proportional spacing, QUME Protocols, QUME Ribbon, QUME Daisywheel 96 characters, maximum characters per line: 180 at 1/15" pitch, copy capacity: 4 copies Centronics Interface, Supports all Wordstar features, paper width 13" max., Optional extras: RS232-C Interface, tractor feed attachment, single sheet feeder.

Amazing Introductory Offer: £219 (£7 carr.)

KAGA KP810



What do the press say:-

"At £269 this is an unbeatable product for what it has to offer." - Educational Computing.

"Offers excellent value for money." - Electronics & Computing.

This new Japanese printer has EPSON FX/RX compatible control codes and is functionally equivalent to an FX80 with the added advantage of its 'Near Letter Quality' mode. It is solidly built and features include: Normal, Italic, Enlarged, super/subscript, proportional spacing and user-defined character set. Extras over the FX80 included in the price are Near Letter Quality (NLQ) print ideal for correspondence, properadjustible tractor feed, half speed quiet mode and 3K buffer. The printer is bi-directional and logic seeking to give a speed of 140CPS for high throughput in conjunction with the standard 3K buffer. 8K RAM may be added to give more user-defined character sets: Centronics parallel interface + Watford's 12 month NO QUIBBLE WARRANTY.

Special Offer: ONLY £235

RS232 interface + 2K buffer to connect to other micros **£89**

KAGA KP910 PRINTER

Very similar to the KP810 but with 17" carriage for really wide print. Gives 156 columns of normal print or 256 columns in condensed mode. This printer is ideal for printing out spreadsheets and can also be used for correspondence in NLQ mode.

ONLY £349

PRINTER LEAD 36"

Centronics lead to connect BBC micro to EPSON, KAGA, SEIKOSHA, NEC, STAR, JUKI, BROTHER, SHINWA etc. printers.

STANDARD (3 foot long) **£7**
EXTRA LONG (5 foot long) **£10**

EPROM PROGRAMMER

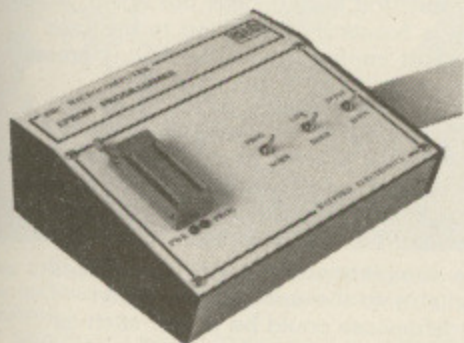

The Watford Electronics' EPROM programmer for the BBC micro is a high quality self contained package. Programs all popular EPROMs from 2K to 16K: 2716, 2516, 2532, 2564, 2764 and 27128. All manufacturers' specifications have been followed to program EPROMs at the correct speed - wrong timings could destroy your EPROMs. The unit has its own power supply so does not put heavy loads on the BBC power supply as do some other units. Connects directly to the 1MHz bus following all Acorn recommendations on addressing and bus loadings.

SOFTWARE PACKAGE

The software is supplied on an EPROM which plugs into the Micro and is instantly available with a single command (no time wasting as on Cassette/disc loading). It is a fully purpose designed and integrated package to simplify ROM development. The system is menu driven with many prompts to avoid any accidents.

Software facilities include:

Load File - Save File - Down Load EPROM - Program EPROM - Verify - Blank Check - Editing of memory contents prior to programming.

Also included is an automatic system to allow Basic programs to be put in EPROM and accessed through the *ROM filing system. More than one program may be put in an EPROM. All these facilities and more are explained in the comprehensive and clear 15 page manual.

ONLY £79 (£3 carr.)

**WATFORD - Always
a step ahead**

TEX EPROM ERASERS

EPROMs need careful treatment if they are to survive their expected lifetime. Over erasure of EPROMs very rapidly turns them into ROMs! The TEX erasers operate following the manufacturers specifications to give the maximum possible working life by not erasing too fast. We use these erasers for all our own erasing work.

- **ERASER EB** - Standard version erases up to 16 chips. £28
- **ERASER GT** - Deluxe version erases up to 28 chips. Has automatic safety cut-off to switch off the UV lamp when opened. £30
- Spare UV tubes. £9

NEW DESIGN PLASTIC LIBRARY CASES

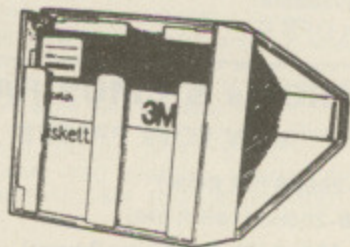

for Disc Storage 5 1/4" (holds 10) £2

DISC DRIVES

(All Drives are NEW SLIM-LINE Type)

NEW LOW PRICES

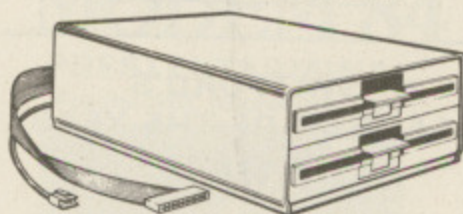

(DRIVES Cased with Cables; connects directly to your BBC Micro)

- **CLS 100** Single, TEC Single sided 40 track 100K, 5 1/4" Disc Drive £112
- **CLS200** Single Drive, Double sided 40 track, 200K, 5 1/4" £129
- **CLS400** Single, Mitsubishi Double sided 80 track 400K, 5 1/4" Disc Drive £165
- **CLS400S** Single, Mitsubishi Double sided 40/80 track Switchable, 400K, 5 1/4" Disc Drive £199
- **CLD200** TEC Single sided 40 track 200K, twin 5 1/4" Drives £225
- **CLD800** Mitsubishi Double sided 80 track 800K, 5 1/4" TWIN Drives £325
- **CLD800S** Mitsubishi Double sided 40/80 track switchable, 800K, Drives £349

P.S.

You do not require a formatting disc nor the expensive 40/80 track switchable drives if you use Watford's sophisticated Disc Filing System which has all these facilities in the ROM.

(CUMANA) DRIVES CASED WITH PSU & CABLES

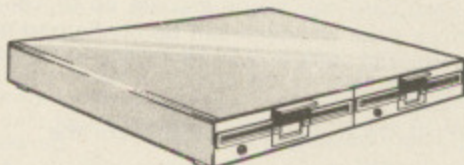
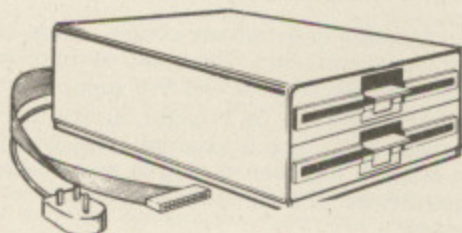

- **CS100** TEC Single sided 40 track 100K 5 1/4" Single Disc Drive £129
- **CS200** TEC Single sided 80 track 200K 5 1/4" Single Disc Drive £175
- **CS400** Mitsubishi Double sided 80 track 400K 5 1/4" Single Drive £199
- **CD200** TEC Single sided 40 track 200K 5 1/4" TWIN Disc Drives £265
- **CD400** TEC Single sided 80 track 200K 5 1/4" TWIN Disc Drives £349
- **CD800** Mitsubishi Double sided 80 track 800K 5 1/4" TWIN Drives £399
- **CD800S** Mitsubishi Double sided 40/80 track Switchable 800K TWIN Drives £425
- SPARE DRIVE CABLES, SINGLE £6; DUAL £8
- DFS Manual (comprehensive) £7.50 (No VAT)

DUST COVERS

(For our Disc Drives)

- Single (without PSU) £3.20
- Twin (without PSU) £3.85
- Single (with PSU) £3.25
- Twin (with PSU) £3.90
- Twin (side by side) £3.95

5 1/4" DISKETTES

Top quality 3M and XIDEX diskettes with a lifetime guarantee. These discs are quiet in operation and insert positively with their reinforced hub rings. Boxes of 10 supplied with disk labels and write protect tabs.

- 10 SCOTCH / 3M + labels S/S S/D £15
- 10 SCOTCH / 3M + labels S/S D/D £17
- 10 SCOTCH / 3M + labels D/S D/D £24
- 10 XIDEX + labels S/S D/D £15
- 10 XIDEX + labels D/S D/D £24

DISC ALBUMS

Attractively finished in beige leather-look vinyl, these conveniently store up to 20 discs. Each disc can easily be seen through the clear view pockets.

£4.25

LOCKABLE DISK STORAGE UNITS

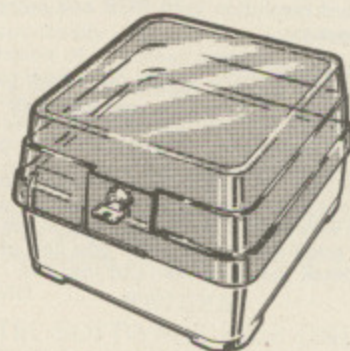

Strong plastic cases that afford real protection to your discs. The smoked top locks down. Dividers and adhesive title strips are supplied for efficient filing of discs.

M35 holds upto 40 discs £13

M85 holds upto 95 discs £18

FLOPPY HEAD CLEANER KIT

The heads in a floppy disc drive are precision made and very sensitive to dirt. Drive manufacturers recommend that you clean the heads approximately once a week. Unless your home or office is dust free one of these kits is a very sensible precaution against losing valuable data. A dirty head can destroy many disks before you realise the trouble. Very simple to use.

Only £14

BBC Micro WORD-PROCESSING PACKAGE

A complete word-processing package (which can be heavily modified to your requirements, maintaining the large discount). We supply everything you need to get a BBC micro running as a word-processor. Please call in for a demonstration.

EXAMPLE PACKAGE
BBC Model B, Watford Electronics' DFS upgrade, Twin 200k Teac drives in beige, Zenith 12" Hi-resolution monitor (Green or Amber), Brother HR15 daisywheel printer, Gemini software: BEEBCALC spreadsheet, analysis and DATABASE software on disc. 10 x 3M discs, 500 sheets fan-fold paper, 4way mains trailing socket, manuals, all leads and BBC carrying case.

ONLY £1,189 (£15 carr.)

ACCESS HOT LINE

(0923 50234)

(24 hours)

Continued

MONITORS

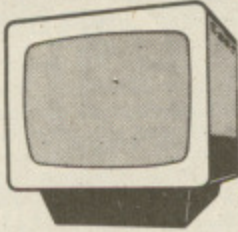

We stock a range of monitors to suit all needs. Choice of a monitor is a matter of personal taste so we recommend that whenever possible, you ask for a demonstration at our shop.

MICROVITEC

- 1431 - Medium resolution as used on the BBC television computer programme ... **£174**
- 1451 - High resolution, suitable for word processing in mode 0 ... **£295**
- 1441 - Super High res, exceeds the capabilities of the BBC micro ... **£389**

All Microvitec monitors are 14" RGB in their distinctive right angled case. They come with the connecting lead to the BBC and a mains plug.

KAGA

- Standard resolution with RGB and composite video inputs ... **£195**
 - High resolution colour ... **£259**
- Kaga monitors are 12" RGB colour with antiglare screen and user access to screen controls.

ZENITH

12" Ultra high resolution monochrome monitor. Ideal for word processing as its green or amber screen is very restful to read. The high resolution makes it good for games too - you can really see the detail that has been put into the graphics. ... **ONLY £75**

LEADS

- BNC for Zenith ... **£3**
 - RGB lead for KAGA ... **£5**
- N.B.** Carriage on Monitors **£7** (securicor)

Versatile BEEB SPEECH SYNTHESISER Unit



SIMPLY the best! - An unlimited speech synthesis system. Complete with easy-to-follow manual. Controlling software is in ROM so no Cassette Loading problems!

PHONEMES for word synthesis - That means unlimited vocabulary! No extra speech dictionary chips to buy!

BUILT-in Library of approximately 500 words to get you started.

ENGLISH accent - Utilises inflexion techniques to produce highly comprehensible speech.

EASY to use system - Just plug the software ROM into a socket, the Speech unit into the User Port, and away you go! No specialised 'dealer upgrade' required!

COMPACT unit - The whole system is built into a small case - easily tucked behind the computer. Auxillary output socket provided for direct connection to an external amplifier.

HOURS of fun! - Suitable for any application - Games, Educational Programs, Specialised Packages.

We know this all seems to good to be true but **DON'T BE LEFT SPEECHLESS!** Order your Versatile Speech Unit now!

Only £44

Best cost less at WATFORD

WATFORD'S LAUNCH OF THE YEAR APEX

The ultimate expansion system for the BBC microcomputer. It enables you to increase memory capacity to 2+ MEGABYTES including BATTERY BACKED-UP RAM.

The system consists of a mother board which fits inside the BBC and further daughter cards can be connected externally. The internal card has the following features:

- 15 ROM/RAM sockets, 11 of which can be configured as 2716, 2732, 2764, 27128 EPROMS or ROM equivalent devices or as 6264 RAMs. Any RAM is Automatically battery backed-up and it's contents preserved when the power is turned off.

- The battery is recharged every time the machine is turned on and lasts several months, depending on the number of RAMs fitted.

- There is very little extra current drain, even with a fully loaded board as only the presently active ROM is powered up. In fact the fully populated board uses only 300mA.

- The board reduces micro bus loading by up to three ROM loads, which improves reliability and performance.

- Installation is extremely simple. There is no soldering required. The board is rigidly held by two 40 pin sockets and five support posts. A ribbon cable can be brought outside the computer and up to 8 external cards added. This enables the user to plug-in up to 142 paged ROMs. The cards have following features:

- Each card can accommodate up to 16 devices each of which can be configured as 2716, 2732, 2764, 27128 ROMs or 6264 8K RAMs.

- Battery backup is provided from the internal card.

- Only the active ROM is powered up permitting many external ROMs to be added with very little current loading (100mA per card).

The system comes with controlling software in ROM. The utilities supplied are as follows:

- ★ APEX - replies with the device number currently being accessed.

- ★ APEX C - toggles between the colour and standard black and white messages.

- ★ AL - loads from any device, regardless of the data type.

- ★ AS - saves memory to any specified RAM device.

- ★ AD - prints a directory of the devices present in the system, i.e. ROMs present and files stored. This also reports on the amount of free storage space.

- ★ AF - asks for the free RAM devices.

- ★ LA - repeats the last command to paged ROMs.

Continued

★ AT - enters a memory testing routine. This will write a test pattern into the memory and read it back out again. If a fault is found, it is reported to the user. This test continues until Escape is pressed.

- RDISC - activates APEX as a filing system which then treats all free APEX RAM in the system as a continuous 'RAM-DISC'. All commands have similar format to the DFS and transfer is possible between the two systems.

The complete computer system bus is available to the user, so that other cards/devices could be added such as EPROM programmers, second processors, Winchester disc drives, clocks, etc. By racking the cards you eliminate the tangled mass of cables that usually accumulates around the micro.

A comprehensive operating manual is supplied with every APEX Board. Please write in for further details and prices.

THE ULTIMATE DFS FOR BBC MICRO

by

Watford Electronics

Highly acclaimed at The ACORN and BBC MICRO USER Shows. What do the independent press say?

Good value for money - *Beebug Aug. '83*
A very worthwhile package - *The Micro User*
You'll be buying a very powerful package - *Personal Computer News*

Superior DFS; Excellent disc sector editor - *Computer Answers*

Without a doubt, the most sophisticated DFS Software yet written for BBC Micro Computer. This powerful new DFS is fully compatible with ACORN DFS yet has much increased power due to additions, carefully designed to make life easier in normal use. It consists of over 14K of efficiently written machine code. It is entirely self contained and so does not require a utilities disc to function.

Please write in for full technical specification.

PRICES:
DFS (Disc Filing System) ROM **£29**

Complete Disc Interface Kit including DFS ROM & Fitting instructions £99

Disc Filing System Manual. Comprehensive and clearly written **£7.50** (no VAT)

P.S. We will exchange your existing ACORN DFS or PACE (AMCOM) DFS for Watford's highly sophisticated 16K DFS ROM for **£25**

Watford's DFS is exclusively available from Watford Electronics. We do NOT retail through any dealers. Every ROM carries a label with our LOGO and a serial number.

Now available:
Acorn DFS Kit **£99**

EPROMs & CMOS RAMs NEW LOW PRICES

2764-250nS (8K ROM)	£5.25
27128-250nS (16K ROM)	£19
6116-150nS (2K RAM Low Power)	£5.25
6264-150nS (8K RAM Low Power)	£28

BEEB PRINTER ROM



This utility ROM is designed to simplify using all the facilities of your printer. It has many facilities:

- ★ Selection of printer modes such as underline, font and size is by 'Single Key' operations.
 - ★ From Wordwise, a single number following OC will select a mode rather than a long and incomprehensible string of control codes. This makes using your printer with Wordwise much more convenient.
 - ★ When using Basic (or other languages) you can have control over the formatting of the output to the printer in the style of a wordprocessor. You can define page top, bottom and side margins etc. with intelligent page skip for binders an option. All supported printers will now respond to form-feed etc. commands.
 - ★ User defined characters are printed as you see them on the screen so that non-standard characters are automatically printed out correctly.
 - ★ Commands select the options for the following printers: GP100, STAR, NEC, MX/FX, KAGA, LP/VII/DMP100, DMP200.
- Operates with either parallel or serial interfaces.
- ★ Supplied with a 50 page manual that is very comprehensive and easy to follow. Please specify printer type when ordering so that we can send the correct function key strip.

Price: £24

DUMPOUT 3

A highly sophisticated screen dump ROM. This has to be the most flexible and powerful screen dump ROM yet produced for the BBC micro. It will put on paper anything you see on the screen, including all Mode 7 facilities etc. We have to admit that there is one facility that we cannot replicate - if anyone can supply flashing ink we would like to know!

The ROM also provides window setting facilities and two new OSWORD calls that allow mode 7 graphics pixels to be read and plotted using the standard graphic co-ordinate system. Two commands are used to operate the dump routines:

- *GIMAGE - This provides a full graphics dump of any Mode (including Mode 8). There are various optional parameters but you need only specify the parameters you wish to change.
- V <scale>, H <scale> - These 2 byte numbers give fine control over the size of the dump from minute to enormous. Unlike other dump ROMs the scale does not change with mode.
- R <0-3> - Print dump rotated by 0.90, 180, 270 degrees.
- I <indent> - Set gap from left edge of paper.
- X <min>, <max>, Y <min>, <max> - The whole of the screen graphics window area is dumped except when these parameters are given.
- P - Physical colour values are used for plotting, otherwise a negative scale is used (white darkest).
- T - Two tone dump for maximum resolution.
- M <mask> - 8 bit colour mask.
- E - Contrast expansion to make mode 7 text and separated graphics stand out from the background.
- C - All mode 7 graphics are printed as contiguous to improve the shading in graphic areas.

*TIMAGE <indent> - Does a fast, text only, dump of the contents of the text window in any mode.

*GWINDOW and *TWINDOW - These commands draw the graphics and text windows, respectively, on the screen and allow them to be changed with the cursor keys. N.B. GIMAGE and GWINDOW work fully in mode 7.

Designed for use with the following printers: CP80, GP80, GP100, GP250, STAR, KAGA/TAXAN, NEC, SHINWA, GEMINI, EPSON MX/RX/FX, LPVII, DMP 100/120/200/400, CANON.

Price including comprehensive manual £22

APPROVED for use with telecommunication systems run by British Telecommunications in accordance with the conditions in the instructions for use.

MODEM 84

PRESTEL TERMINAL
For the BBC Microcomputer

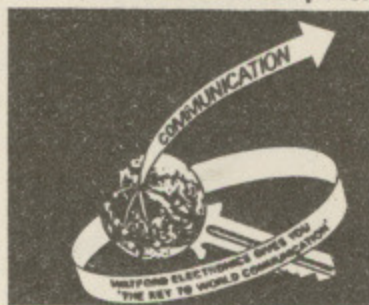

The Watford Prestel package allows B.T. approved connection to Prestel, Micronet and many other 1200/75 baud databases for about the cost of a good tape recorder. Prestel gives you access to an incomparable database covering almost every subject under the sun. There is Micronet with lots of free programs that you can download and run. Details of clubs and user groups, a diary of meetings and exhibitions, news and reviews, technical information etc. There is Homelink with online banking. And there is armchair shopping, travel information, entertainment, world news, sports news, weather information, electronic mail and lots more.

The basic Prestel subscription is only £5 per quarter and at off peak times there is no charge for access time. A local phone call facility means no long distance phone calls to Prestel (approx. phone cost is only 40p per hour).

The Watford Prestel package consists of the B.T. approved Watford MODEM 84 (1200/75 baud full duplex 1200 baud half duplex direct connect) and a very sophisticated Prestel Terminal ROM.

This totally machine code software:

- is fully compatible with not only the Modem 84 but also with the PRISM 1000 and most other modems that require a data link via an RS423/RS232 port making it a worthwhile purchase for those who already have Modems.
- supports full Prestel colour alpha and graphic characters including double height, flashing, conceal/reveal.
- called by simple *PRESTEL (*P.) command. Disc and tape configurations fully supported.
- includes a comprehensive telesoftware downloader for BBC and other programs with continuous on screen status report (an essential facility).
- has very powerful OFF LINE MAILBOX editor allowing colour flashing graphic mailboxes to be prepared without having to be on line to Prestel.
- auto logon sequence can be burnt into ROM if desired.
- a vital 'TAG' facility allows tagging and recall of interesting pages, avoids that common and annoying 'NOW WHERE WAS THAT PAGE' problem.
- includes simple page and program loading and saving functions for both disc and tape, automatically assigning frame and program directories.
- not one but TWO PRINTER DUMP ROUTINES are provided within the software allowing either full graphics dump (mode 7 to EPSON compatible printers) or ASCII characters only.
- a user function built into the software allows interface with specialist routines, (yours as well as ours).

EPSON DUMP ROM

This screen dump ROM is specifically designed for use with the Epson RX/FX printers and the Kaga KP810. It is extremely simple to use as there is only one command to remember. It will accurately dump any screen mode using multiple tones as required. Mode 7 is fully supported giving teletext graphics, double height etc. For those who like to keep life simple this EPROM is only £20.

FORTH ROM for BBC

This ROM provides a complete implementation of the FIG-FORTH standard (including editor). Supplied with a large tutorial manual at only £33

TINY PASCAL for BBC Micro £59

- All the above facilities are accessed via function keys. An overlay is provided to give comprehensive guidance to key functions.
- A 34 page comprehensive instruction/operating manual is supplied.

WATFORD'S 1200 BAUD FULLY AUTOMATIC USER TO USER SOFTWARE

Having purchased the WATFORD PRESTEL TERMINAL which includes the 1200/75 baud MODEM 84 the addition of the WATFORD user to user ROM based software enables you to discover a whole new world of data communication.

This software enables you to use the MODEM 84 very powerfully.

- Send and receive error checked programs and files (even WORDWISE files) to and from other users at 1200 baud.
- 8k file transfer in under 2.5 minutes (approx four times faster than with 300 baud modems).
- The transfer of data is totally AUTOMATIC which means that the modem is automatically switched between transmit and receive under software control.
- A chat mode is provided which also has this automatic switching for receive and transmit. (This mode is essential just before and after data transfer when both hand sets are replaced to reduce noise).
- A copy facility is provided which allows transmission of all screen output.
- A continuous on screen modem status report is included.
- The software is totally function key driven enabling easy transmission, reception, saving and loading of programs and files (Basic, Machine code or Data).
- A help menu is available from within the software as an aid to use.
- Full instructions are supplied.

PRICES

PRESTEL SOFTWARE ROM ONLY (incl. Comprehensive Manual) £20
PRESTEL PACKAGE comprising:
WATFORD MODEM 84, SOFTWARE ROM and Comprehensive Manuals £82 (carr. £2)
USER TO USER SOFTWARE ROM £14

VIEW

VIEW WORDPROCESSOR

We are supplying the new VIEW version 2.1 allowing printing of memory contents etc. . . £49

FX80 PRINTER DRIVER Watford's own TWO Sophisticated PRINTER DRIVER for VIEW

To simplify using the full facilities of the Epson FX80 or Kaga KP810 use this printer driver. Full facilities are provided for selecting between fonts etc. The disc includes examples of use and instructions. Available on 40 or 80 track disc (please state which required). £6

WATFORD ELECTRONICS VIEW PRINTER DRIVER FOR SILVER REED

We are pleased to introduce a new range of printer drivers to complement the Silver Reed range of printers and typewriters and the View wordprocessor. These drivers have been officially approved by Silver Reed, for use with their printers and typewriters. The View driver allows access to all of the features supported by the range of daisy wheel printers (EXP 700/400/500/550). These include underlining, bold, shadow, superscript, and subscript printing. Additionally, you can use proportional spacing on the EXP 700. Owners of one of the typewriters in the range EXP 55/44/43, using it as a printer, can also access underlining with these drivers. The features of each printer/typewriter are accessible from the two highlight codes, which can be redefined at any point within the text. The printer drivers also extend the facilities in View to allow the use of pad characters. The printer driver on disk with a user manual is at a special introductory price of £7.50. Please specify printer type when ordering.

WATFORD ELECTRONICS

Continued

TWO DATABASE MANAGEMENT SYSTEMS

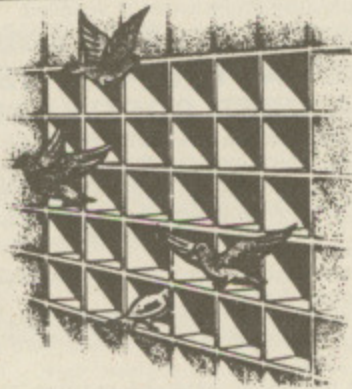

DISCDATA

Discdata is an entirely disc based database handling system. It is extremely easy to use through its comprehensive menu system. The simplicity is such that we do not feel the need to provide explanation on use in the written guidance supplied with the program. The first-time database user will rapidly become familiar with this package designed throughout to be simple and obvious. Despite the ease of use this system provides all the facilities needed for complex data handling problems. The length of database that can be handled is only limited by the total space on the disc. You can have up to 20 fields with page length records up to 254 bytes in length. Adding and deleting records, amend titles, field names and records. Sort on any field and search for any record or group of records in any field. The database may be re-formatted after creation, the system will re-write all your files for you automatically. You may add extra fields and extend the length of existing fields freely. Output formatting is very powerful. You are allowed 40, 80 or 132 column output modes going to printer or screen. Selected fields can be put in any order on the screen or printer, either across the paper or down. Output can start or stop anywhere in the file. Decimal fields are automatically totalled and records output are counted. Version 2, now on sale has improved input and amendments procedures giving full record edit as well as the 3 extra features... String searching, Calculations on numeric fields, and the ability to create sub files from your main files.

On disc at **Only £17**
(Please specify 40 or 80 track when ordering)

FILE-PLUS

The File-Plus package is even more powerful and flexible than Disc-Data. It is also largely menu driven but has its own command language for file searching. The 16K ROM contains all the normally required routines, with lesser used options supplied on the utilities disc. All input and output formatting is controlled through screen forms. A full screen editing system is used to define a form which allows tremendous flexibility in the format in which your data is displayed. It is very easy to change from form to form so that you can type in your data with one form, and examine it with others. You will typically design several forms before starting to access the database so that you can quickly and easily see the fields of each record that you want to appear in the layout you decide on. The form system is also used for output to your printer. File Plus has a unique file linking system that allows the entire on-line storage of your system to be used for one database. This can give around 1.5 Megabyte databases using dual drives and double density. The built in FQL (File-Plus Query Language) can be used for searching the database. Presented in the form of a powerful command language with looping facilities etc. this allows the most flexible access to your data possible. Full arithmetic operations are provided to allow the system to be used for statistical analysis. Operations supported are -, +, *, /, + - 9999999999.9999 and compare facilities = >, <, +, =, >=, <=, &. Many keywords are supported by the language: assign, compare, display, end, goto, iff, ift, print, read, search, spool and update. Supplied with a very detailed 70 page manual to explain all the facilities with many examples.

Only £43

(Please specify 40 or 80 tracks for the utilities disc)

BUFFER & BACKUP ROM

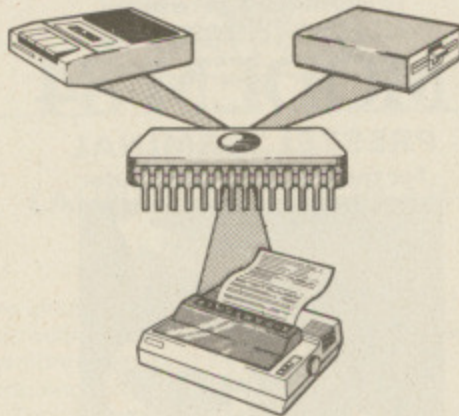

For those with sideways RAM fitted in their machines this utility ROM will make full use of this facility. By using the sideways RAM area for extra memory the following features are implemented:

- ★ 4K or 16K buffer for parallel printer.
- ★ Dumps selection of Disc files to Tape.
- ★ Makes backup copies of tapes on to tape and disc.
- ★ Displays contents of paged ROMs on screen.
- ★ Menu display of ROM filing system contents on Shift-Break.
- ★ Comprehensive manual.

Only £22

DATAGEM

Gemini's 24K ROM based DATABASE Management System
Special Introductory Offer: **£99**

WONDERFUL WATFORD

PEN PAL - VERSATILE LIGHT PEN SOFTWARE

Do you have a light pen that never gets used? Then this piece of software is for you. This package offers many useful facilities that make the light pen a useful device to own. Facilities included are:

- Pixel, Line and Character definition
- Free hand drawing
- All Colours
- Fill, Refill and stripes
- User defined "Brush strokes" plus character definer
- Grid, Scale and perspective aids 2 to 200 points palletable in one design with Circles and "rubber banding"
- Move design/character to any screen position
- Save and Load screens, User defined characters and line drawings for video titles, own programmes etc.

This program has many uses in education and at home. It is supplied with a comprehensive instruction manual. Works with Watford, RH, Acorn User, DIY and many other Light Pens.

Prices
TAPE **£10**
DISC (40 or 80) **£11**

DISC EXECUTOR

Disc Executor is a sophisticated disc utility for the transfer of your cassette programs to disc. If you have difficulties transferring your cassette software to your disc system then this is the answer. It handles 'locked' files and full length adventures (up to &&e blocks) and programs that load below &E00. It is very simple to operate with instructions supplied. It saves you time and money.

Price £10

(Please specify 40 or 80 track discs)

ADE

Complete program development package in a 16K ROM. Full assembling and debugging facilities provided.

SPECIAL OFFER ONLY £43

ROM MANAGER

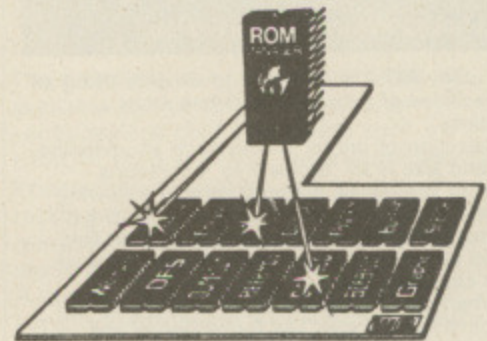

This ROM is unique in its capabilities. It allows you, the user, full control over the BBC Micro's sideways ROM paging system with simple to use commands. This ROM is essential for those with several ROMs. At a simple level ROM MANAGER can be used to remove the problem of clashing command names and allow full use of all the facilities of your ROMs. This is coupled with facilities to completely enable or disable various ROMs in the machine including ROM manager itself. ROM MANAGER can also be used to develop sideways ROMs using the machine's standard memory. This is achieved by sending sideways ROM calls to your code in RAM, saving the expense of fitting sideways RAM for ROM development purposes. ROM status reports are also given by the ROM, including ROM lengths, checksums, entry points supported and current filing system title. The ROM also provides facilities to examine ROMs, list function keys for editing, modify RAM (using a HEX/ASCII editor) and list ROM titles neatly and concisely.

The commands given in the ROM:

- **CHECKSUM** - Generates a CRC for a specified ROM (useful for testing suspected faulty ROMs).
 - **DIRECT** - Passes a command directly to a named ROM (overcomes command name clashes).
 - **EXAMINE** - Allows examination of a named ROM.
 - **EXPLAIN** - Gives detailed explanation of the first 22 *FX codes.
 - **FILE** - Passes a command directly to the current filing system (which normally receives commands after all the ROMs).
 - **FUNCTION** - Lists the contents of the function keys in a form suitable for editing.
 - **INCLUDE** - Allows the main memory to be used for ROM development.
 - **MODIFY** - Memory editing in HEX/ASCII format.
 - **NAMES** - Lists the names and socket numbers of all resident ROMs.
 - **RAM** - Sends command directly to the RAM based ROM routine.
 - **REMOVE** - Removes RAM based ROM option.
 - **SPECIFY** - Selects the default ROM.
 - **DEFAULT** - Sends commands directly to the default ROM without having to give its name.
 - **STOP and START** - Disable and enable any named ROM to completely eliminate command word clashes.
 - **STATUS** - Information about all the ROMs fitted in the machine including socket number, name, length, whether it is enabled, whether it has service or language entries etc.
 - **VALUES** - Gives ROM MANAGER status information, such as its socket number, how many ROMs have higher priority, number of default ROM and the identity of the current filing system.
 - **VECTOR** - Same as *DIRECT, just in case *DIRECT clashes with another ROM.
- All selection between particular ROMs is by the name of the ROM and this may be abbreviated for convenience. ROM numbers can also be used if required. This ROM is very simple and obvious to use. All the facilities are explained in the clear and detailed manual.

Price £22

Watford's
written by
of the f

The most p
monitor RC
all the nor
relocating
screen edit
memory, e
assembler
In use as a
a total em
urge to set
- you can
writing loc
contents. T
of sideways
easily be r
there DFS
used in tot
Beebmon
can nest B
the memor
workspace
on the 1M
zero page
BASIC) ca
How does
interpreter
in a virtua
like the RC
by your pr
in Beebmo
allows imm
level by ct
being excu
power and
clear and
for money

Discover th
OPERATING
programme
A ROM ba
the BBC m
programs t
and thus is
in assembl
disk or tap
comprehe
altered dir
and BINAF
set of labe
labels), wi
already lab
Thus DIS-
such as BF
effect as i
memory e

BEEB MON

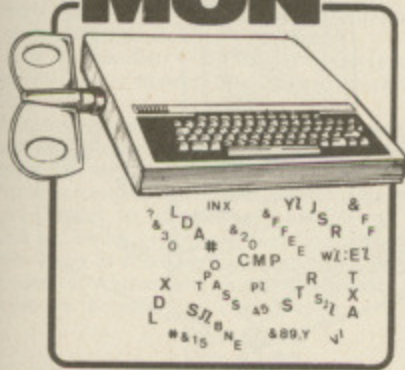

Watford's own Machine code Monitor ROM written by Andrew Bray (Cambridge), co-author of the BBC Micro Advance User Guide.

The most powerful and versatile machine code monitor ROM yet written for BBC Micro. It has all the normal memory editing, moving and relocating facilities, plus all editing is with a full screen editor allowing scrolling up and down memory, entering in Hex, ASCII or standard assembler mnemonics.

In use as a debugging tool, you run code under a total emulation system. Ever felt a desperate urge to set a break point in ROM? No problem - you can even have breakpoint on reading or writing locations in memory and on register contents. The system fully supports debugging of sideways ROMs e.g. BASIC can fully and easily be run from within Beebmon and from there DFS and other sideways ROMs can be used in total emulation mode. Beebmon can even run itself. In so doing you can nest Beebmon up to a level limited only by the memory size. Beebmon uses 256 bytes of workspace, located anywhere in memory, even on the 1MHz Bus. Beebmon effectively uses no zero page workspace, so your program (e.g. BASIC) can use any or all of the base page. How does it achieve this? By providing a 6502 interpreter all programs running under it exist in a virtual BBC, so special memory locations like the ROM latch are not actually accessed by your programs, instead they alter a location in Beebmon's workspace. Emulation also allows immediate return to Beebmon command level by ctrl-escape no matter what code is being executed at the time. All this exceptional power and flexibility is complemented by a clear and detailed manual included in a value for money price of:

£22

Disassembler Rom



Discover the hidden secrets of BASIC and the OPERATING SYSTEM with this easy to use programmers tool.

A ROM based machine code Disassembler for the BBC micro. It enables machine code programs to be listed in BASIC/DUMP format and thus is the perfect complement to the built in assembler. It allows Sideways ROMs, files on disk or tape to be listed, and also has a comprehensive editor, allowing mnemonics to be altered directly, as well as HEX, DECIMAL, ASCII and BINARY memory editing. There is also a full set of labelling facilities available (up to 3,200 labels), with the major locations and routines already labelled.

Thus DIS-ASM enables any monitor program, such as BEEBMON to be used to much greater effect as it is not necessary to disassemble memory each time the display is altered.

ONLY £18

WATFORD - Always a step ahead

COMPUTER CONCEPT'S ROMS

CARETAKER Basic Utility	£28
Graphics ROM	£28
Disc Doctor ROM	£28

Wordwise

Without doubt a very sophisticated piece of software for the BBC Micro. It has all the features of a professional word processor yet is easy to use.

SPECIAL OFFER THIS MONTH: £32

BEEBFONT ROM

BEEBFONT is a remarkable and different concept in BBC software supplied on a 16K ROM. It allows you to display text on the screen in any of the following styles:

ABCDEFGHIJKLMNPO
 abcdefghijklmnop
 ABCDEFGHIJKLMNPO

ABCDEFGHIJKLMNPO
 abcdefghijklmnop
 ABCDEFGHIJKLMNPO

ABCDEFGHIJKLMNPO
 abcdefghijklmnop
 ABCDEFGHIJKLMNPO

ABCDEFGHIJKLMNPO
 abcdefghijklmnop
 ABCDEFGHIJKLMNPO

ABCDEFGHIJKLMNPO

It works in modes 0, 1, 2 and 4 using the full colour capabilities of each mode. Characters are printed in the same way as normal. Selection between the various fonts is very easily achieved with Ctrl-V - press this followed by a font number and the output will continue in the new font. Beebfont ROM is particularly useful in display work with the characters produced at twice the normal size.

You can create your own character fonts with the editor supplied. You can also print-out pre-formatted text files using the special characters with Epson FX, RX and NEC printers. The full range of character styles can be used, controlled from within the text. The editor and spooler program are supplied with the package, on cassette or disc. The spooler allows word processor (Wordwise & View) output to be printed in the new characters.

A twenty page manual is supplied. Please state printer type and media for the editor & spooler when ordering (cassette, 40 or 80 track disc).

ONLY £39

NEW LAUNCH

32K RAM EXPANSION BOARD

Now Watford Electronics brings you the latest state-of-the-art memory expansion board for your BBC microcomputer. This compact board which fits inside the computer does not just give you 16K or even 20K of extra RAM, but a massive 32K!!!

There are many useful facilities available with this board:

- The top 20K of the expansion RAM can be used as the screen display memory, leaving all the standard BBC RAM free for programs or data storage. This allows good graphics and long programs to be combined. For instance you could have MODE 0/1/2 GRAPHICS AND 28K OF PROGRAM SPACE. The extra RAM can be used by virtually any language or utility such as BASIC, VIEW, WORDWISE, etc.

- The full 32K or the bottom 12K of the expansion RAM can be used as a buffer for the printer, sound channels, RS423, keyboard or speech synthesiser. This allows very long text files to be printed while you are using 27K of program and 20K of graphics!

- This board is the ideal complement to any word processing system. There is no need to wait for slow printers as you can type in long text in 80 column display mode while printing is going on - TWO JOBS DONE SIMULTANEOUSLY!!! (an equivalent printer buffer would cost you £115+).

- The board is compatible with a vast range of software and hardware available for the BBC microcomputer, including our ROM expansion board and double density DFS.

- The board is extremely easy to fit. It is supplied complete with a comprehensive manual and ROM based software with full *HELP messages.

SPECIAL INTRODUCTORY OFFER

Only: £69 (carr. £1)

GRAPH PAD

With this popular British Micro's Graph-pad, you can add new dimension to your computer enjoyment. It helps you to create your own application programs by the simple use of the Graphpad. Ideal for Educational use. Supplied complete with Cables, Manual and a two program cassette.

Price: £115

SURGE PROTECTOR Plug

Fitted in place of your normal mains plug, this device protects your equipment against mains surges. Nearby lightning strikes, thermostats switching and many other sources put high voltage transient spikes on to the mains. This can lead to data corruption in memory and on disc and can result in spuriously crashing machines. Suitable for computers, Hi-Fi, Fridge Freezers etc. Max. Surge current 2KAmp; max. Voltage 250. Essential for serious computer users.

Protection for only £8.50

WATFORD ELECTRONICS

Continued

DOUBLE DENSITY DISC INTERFACE

We are proud to announce the launch of the Watford Electronics Double Density Board for the BBC micro. The DDFS supplied is a new version of the popular Watford Electronics DFS re-written to make full use of the capabilities of the new double density controller.

- Storage is increased by the maximum physically possible, 80%.
 - Our system will use the whole of an 80 track drive. Inferior systems do not allow files longer than &3FFFF bytes, but with our system files can be as long as one disc side.
 - Discs may be created in either single or double density format with the built in formatter and in single density mode are fully compatible with normal Acorn format discs.
 - The density of the disc you put in is automatically sensed by the system and you are informed of the density in the catalogue display.
 - The double density system is of course faster than single density.
- Worried about compatibility with single density discs? Don't. The Watford Electronics DDFS implements an extremely comprehensive 8271 emulator so that commands passed through OSWORD &7F are correctly interpreted. Other manufacturers thought that read and write sector alone were sufficient - we decided to implement every command of the 8271 that was physically possible. We have allowed the use of all the special registers including bad tracks, allowed access to deleted data etc., etc. The emulator itself takes up around 1K of compactly written machine code. We reckon it will run the vast majority of protected discs now available. Gain all the advantages of the WE DFS together with much increased storage and compatibility with existing protected discs. The price is the same as for the standard single density system that we continue to sell so you can choose between the two options without financial worries.

NEW LAUNCH

SIDEWAYS ZIF

External sideways ROM socket

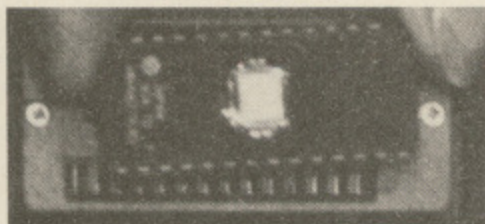

At Watford we haven't forgotten those of you with small budgets, so we've produced a ROM board which takes only one ROM! But don't stop reading - this ROM can be changed in under five seconds without taking the case apart. The SIDEWAYS ZIF eliminates the possibility of damage to your ROMs as zero insertion or extraction force is required when changing ROMs.

Included in the SIDEWAYS ZIF package is a specially designed see through storage container for your ROMs which protects them from mechanical and static damage when not in use. Consider the features:

- Very simple to install, no soldering or modifications to the BBC Micro are required.
- Uses a professional ZERO INSERTION FORCE SOCKET (ZIF) so no force is required changing a ROM.
- No further expense, ROMs are used as supplied without expensive specialised cartridges. The storage box included stores up to 12 ROMs in perfect safety.
- Fits neatly into the existing cartridge slot on the lefthand side of the BBC Micro keyboard.
- The low profile design of the socket gives unrestricted access to the keyboard, unlike other cartridge systems.
- Allows easy installation and changing of Sideways ROMs, all without dismantling your BBC Micro. Once locked in position in the ZIF socket the ROM behaves as a normal sideways ROM.
- No more problems of running out of socket space, simply unplug the ROM and plug a different one in!

A REAL MUST FOR PROFESSIONALS AND HOBBYISTS ALIKE
ONLY £16

BOOKS (No VAT on Books)

30 Programs - BBC Micro	£3.25
30 Hour BASIC (BBC Micro)	£6.95
35 Education Programs for BBC	£6.95
36 Challenging Games for BBC	£5.95
40 Educational Programs for BBC	£5.95
100 Programs for BBC Micro	£6.95
Cassette version of above	£10.00
6502 Application Book	£11.95
6502 Assembly Language Program ..	£13.95
6502 Assembly Language Subroutines	£14.25
6502 Machine Code for Beginners	£5.95
6502 Software Design	£10.50
A young persons guide to BBC Basic ...	£4.50
Advanced Machine Code Technique for BBC	£7.95
Advanced User Guide for BBC Micro	£11.95
Advanced Graphics with BBC	£9.95
Advanced 6502 Interfacing	£10.95
Advanced 6502 Programming	£12.45
Assembly Language Programming on BBC Micro	£7.95
Advanced Programming Techniques for the BBC Micro	£7.95
BBC Basic	£7.95
Assembly Lang. Prog. on BBC	£7.40
BBC BASIC	£5.95
BBC Basic for Beginners	£6.95
BBC DIY Robotics & Sensors	£6.95
BBC Forth	£7.50
BBC Lisp	£7.50
BBC Micro An Expert Guide	£6.95
BBC Micro Book BASIC Sound & Graphics	£7.95
BBC Micro Graphics and Sound	£6.95
BBC Micro Programs in Basic	£5.95
BBC Micro ROM PAGING System Explained	£2.00
BBC Micro Revealed	£6.95
BBC Micro Assembly Lang. Prog.	£7.95
BBC Micro Disc Companion	£7.95
BBC Micro in Education	£6.50
Basic Programming on BBC Micro	£5.95
Best of PCW Software (BBC)	£5.95
CP/M Users Guide	£13.95
Creating Adventure Programs on BBC Micros	£6.95
Creative Graphics Cassette (Acornsoft). Has 36 graphics programs	£8.95
Creative graphics on BBC Micro	£7.50
Complete Programmer for BBC	£5.95
DISC FILING SYSTEM (DFS) Operating Manual for BBC	£6.95
Discover BBC Machine Code	£6.95
Discover FORTH	£13.95
DIY Robotics & Sensors with BBC	£6.95
Further Prog. for BBC Micro	£5.95
FORTH Programming	£14.40
Functional Forth for the BBC Micro	£5.95
Games on your BBC Micro	£2.95
Games BBC Computer Can Play	£6.95
Graphs & Charts on BBC Micro	£7.50
Graphic Art for BBC Computer	£5.95
Graphs and Charts (Cassette)	£7.50
Graphics on BBC Micro	£6.95
Hobbit (Book and Cassette)	£14.95
Introducing the BBC Micro	£5.95
Introduction to FORTH	£9.30
Intro to Micro Beginners Book (3 Ed.)	£9.90
Let your BBC teach u to program	£6.45
LISP	£9.25
Logo Programming	£8.95
Mastering VISICALC	£12.45
Mastering CP/M	£13.65
Micros in the Classroom	£4.90
Programming the 6502	£11.95
Programming & Interfacing 6502	£16.00
Programming the BBC Micro	£6.95
PASCAL	£9.25
Programming for Education on BBC ..	£5.95
Structured Prog. with BBC BASIC	£6.50
The Complete FORTH	£6.95
The BBC Micro Book, BASIC, SOUND & GRAPHICS	£7.40
Using Floppy Discs with BBC Micro	£5.95
Using BBC Basic	£6.95
Using 6502 Ass. Language	£14.50
Wordstar & CP/M made easy	£6.95

PLINTHS FOR BBC MICRO AND PRINTERS

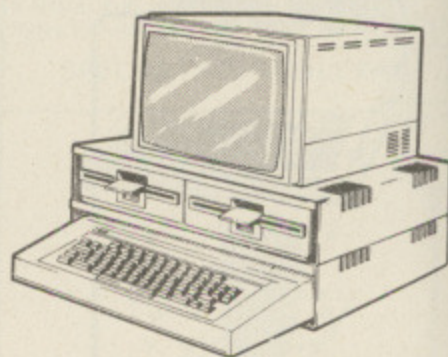

Protect your computer from the weight and heat of your monitor. BBC micro plinths have slots for maximum ventilation. Single height version is suitable for BBC and monitor. Double height version allows the disc drives to be used in the centre section or stationary, etc. The computer slides easily in to place, allowing easy access to remove the lid. The printer plinth is equally sturdy but without the cooling slots. This allows the paper to be stacked under the plinth with the printer on top - a very convenient way to work as it does not require the usual very deep table.

SINGLE BBC PLINTH	£11 (carr. £1.50)
DOUBLE BBC PLINTH	£20 (carr. £2.00)
PRINTER PLINTH	10 (carr. £1.50)

4 WAY MAINS DISTRIBUTION SOCKET

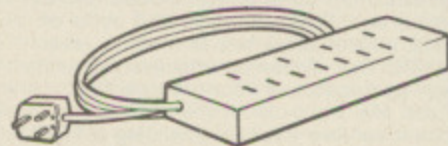

4 way top quality mains trailing sockets. Supplied wired up with mains plug ready for use. Can be screwed to floor or wall if required. Very useful for tidying up all the mains leads from your peripherals. Allows the whole system to be switched on from one plug.

£9.50

ASSORTED CONNECTING LEADS

(All ready made and tested)

CASSETTE LEADS 7 pin DIN Plug to 5 pin DIN Plug + 1 Jack Plug	£2.00
to 3 pin DIN Plug + 1 Jack Plug	£2.00
to 7 pin DIN Plug	£2.50
to 3 Jack Plugs	£2.00
6 pin DIN to 6 pin DIN Plug (RGB)	£2.50
MONITORLEADS	
Microvitec RGB leads 6 pin DIN to 6 pin DIN for colourmonitors	£2.50
KAGA/SANYO Colour Monitor Leads	£5.00
Monochrome monitor leads BNCToPhono	£3.00
DISC DRIVE POWER LEADS	
Supply from BBC power supply to standard Disc Drive connector.	
Single	£3.00
Dual	£3.75

MISCELLANEOUS CONNECTORS

	Plugs	Sockets
RGB (6 PIN DIN)	30p	45p
RS423 (5 pin Domino)	40p	50p
Cassette (7 pin DIN)	25p	65p
ECONET (5 pin DIN)	20p	30p
Paddles (15 pin 'D')	110p	215p
BBC Power Plug 6 way	80p	-
Disc Drive Plug 4 way	75p	-

ATTACHE CARRYING CASE for BBC Micro

The Attache carrying case is attractively finished in mottled antique brown leatherette. The case is made of tough plywood, providing a very solid and safe way to carry your BBC micro. There is room provided to fit all the leads necessary behind the computer and manuals in the front. Locks supplied with two keys. Price £12 (£2 carr.)

VOLTMACE DELTA 14 JOYSTICK SYSTEM

The Voltmace system provides full facilities for connecting the Delta 14 handset.
Delta 14 handset - On its own makes a high quality centre sprung analogue joystick with fire buttons **£12.50**
Adaptor Module allows use of two joysticks and provides hardware to access all the keys on the keypad of the joystick **£12.55**
Transfer program allows use of the keypad keys and joystick to simulate any key on the keyboard. This works by creating a machine code patch that stays in memory while another program is loaded in. Allows any game to be used with joysticks. Supplied on disc or tape.

Tape **£5.10**
Disc **£7.95**

STANDARD JOYSTICKS

These are standard analogue type with a fire button on each joystick. Twin joysticks go to a single moulded plug, long leads provided.

Single Player version **£7.00**
Two Players version **£12.00**

GAMES SOFTWARE

ADVENTURE QUEST (L.9)	£8.50
COLOSSAL ADVENTURE (L.9)	£8.65
CHESS	£6.95
CHUCKIE EGG	£7.90
CRAWLER (WESOFT)	£5.00
CROACKER	£6.95
DUNGEON ADVENTURE (L.9)	£8.50
Escape from MOONBASE ALPHA	£6.95
FELIX in the FACTORY	£6.95
GALACTIC COMMANDER	£6.95
KILLER GORILLA	£6.95
MUNCHYMAN	£5.95
MOONRAIDER	£6.95
MUSIC SYNTHESISER	£8.25
PENGO (Watford)	£5.95
SNOWBALL (L.9)	£8.50
SWOOP	£6.95
Twin Kingdom Valley	£8.25
747 FLIGHT SIMULATOR	£7.75

CRAWLER

A new challenge for your reflexes from Watford Electronics. Crawler is the best yet implementation on the BBC micro of the arcade game 'Centipede'. Blast the voracious caterpillar before it eats you, while avoiding the wandering spiders. Passing scorpions poison the mushrooms causing the caterpillar to fall straight on to you. Falling fleas also induce massive mushroom growth. This game is fast and fluent to play, suitable for all skill levels. The control system is cleverly arranged to give high speed movement AND precise control of position.

A SUPERB GAME FOR ONLY **£5**

LEVEL 9 ADVENTURES

Level 9 have the highest reputation for their adventure range. Each one is in itself a challenge that could take you months to crack. All feature the ability to save your current position on tape. These adventures understand many words and have vast numbers of rooms.

COLOSSAL ADVENTURE - The classic adventure as provided on most mainframe computers. Has all the original puzzles with 70 extrarooms. **£8.65**

ADVENTURE QUEST - Through forest, mountains, desert, caves, water, fire, moorland and swamp fight an epic quest against tyranny. **£8.50**

DUNGEON ADVENTURE - Cover 100 puzzles in the Demon Lord's dungeon. **£8.50**

SNOWBALL - Science Fiction adventure set in 2302 AD. Save a colony starship full of frozen people. 7,000 locations must make this the biggest adventure on the BBC micro. Has robots, flashing control panels, etc. etc. Really good fun! **£8.50**

SPECIAL OFFER

HITACHI EPROMs for BBC

2764(8K) **£4.95**
27128 (16K) **£19**

HITACHI RAMs for BBC

6116L(2K) **£4.25**
6264L (8K) **£26**

MK 2 13 ROM SOCKET EXPANSION BOARD

Now all lines fully buffered - On board battery back-up facility - will now accept EPROMs 2716, 2732, 2764 & 27128 and ROMs 6116 & 6264.

Simply plugs into one of the four ROM sockets currently available in BBC Micro. There are only 5 solder connections to be made. Full

instructions are supplied. This board has been ergonomically designed to enable the user, easy further expansion inside the Micro, e.g. Double Density Board, Torch Board, etc. (At Watford, we think ahead.)

Our Mk2 13 ROM Socket Board enables the User to increase the sideways ROM capacity from the basic 4 sockets upto full 16 capable of being supported by current operating systems. In addition the board is designed with the facility to hold upto 16K RAM, which when switched into operation is automatically selected by any WRITE signal to the Sideways ROM area. This gives the User the ability to write a utility or language and upon pressing break have the utility or language up and running (new ROM software can be developed and tested in situ.)

The Board gives the User, plenty of freedom to explore the possibilities of the new paged ROMs due in the coming months and offers them the chance to develop their own.

All lines are fully buffered and the Board meets or exceeds all timings for operation in the BBC Microcomputer. When fully populated, the ROM Board consumes less than half the recommended maximum current limit.

Supplied ready-built and tested complete with fitting instructions.

ONLY **£32.50** (carr. £1)

THE INVESTIGATOR

A utility program provided on disc to make security backup copies of all your valuable discs.

Makes full use of all 8271 facilities to discover the precise format of your protected disc so that an exact copy can be produced. Supplied with detailed instructions. Please specify 40 or 80 track disc when ordering.

Price **£25**

LIGHT PEN

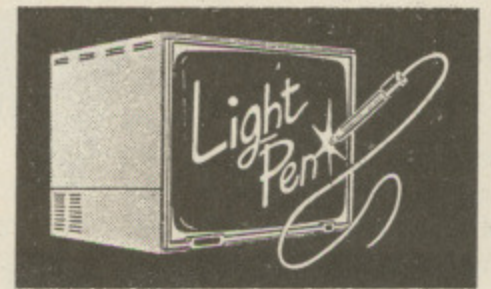

This Light Pen for the BBC micro is packaged in a neat pen shape with built in switch. Supplied complete with our sophisticated Pen-Pal software on cassette (see elsewhere in this ad).

Only **£20**

(For software on disc please add £2)

DATA RECORDER AND ACCESSORIES

Top quality slimline portable cassette recorder designed specifically for use with home computers. Mains/Battery operated with tape counter.

£24

DATA CABLE to connect recorder to BBC

£2.50

DATA CASSETTES - Top grade tested C12 Data cassettes supplied in library cases **35p**

MISCELLANEOUS

28 pin DIN PLUG	
Solder type	£1.85
IDC Crimp type	£2.90
28 pin ZIP SOCKET (Textool)	£7.50
34 way Ribbon Cable	£0.60/foot
8 way DIP SWITCH	£0.87

ANTI GLARE MONITOR SAFETY SCREEN



HEADACHES? TIRED EYES? Don't take pills - Use a Watford Electronics anti-glare filter! Considerable research into the possible health problems associated with monitor screens has shown that eye strain, blurred vision, watering, itching eyes and headaches can result after prolonged use. The problems are caused by extraneous reflections which force the eye to continuously re-focus to try to ignore them. The answer is our contrast enhancement, anti-glare filter which is similar to those which have been previously available on business systems, but at the low cost that you would expect for your personal computer. You will soon find the reduction in eye strain well worth your investment.

- Features:
- Simple fitting with sticky Velcro pads.
 - Easily removed for cleaning.
 - Tinting improves colour quality and contrast.
 - Works on monochrome or colour monitors.
 - Curved instead of usual flat screen reduces edge distortion.
 - Made in Britain by a long established glass maker.
- Available in 12" or 14" versions - please specify when ordering.

Introductory offer price: **£14.95** (carr. £1)

Prices subject to change without notice and availability.

MAIL ORDER AND RETAIL SHOP. TRADE AND EXPORT INQUIRIES WELCOME. GOVERNMENT AND EDUCATIONAL ESTABLISHMENTS OFFICIAL ORDERS ACCEPTED. CARRIAGE: Unless stated otherwise, please add 75p to all cash orders.

VAT: UK customers please add 15% VAT to the total cost incl. Carriage.

SHOP HOURS: 9.00am to 6.00pm. Monday to Saturday. (Ample Free Car Parking Spaces) ACCESS ORDERS: Simply phone: Watford (0923) 50234. (24 Hours)

Watford Electronics

Dept. BBC, Cardiff Road, Watford, Herts, England.
Telephone: 0923 40588/37774. Telex: 8956095

We've MOVED

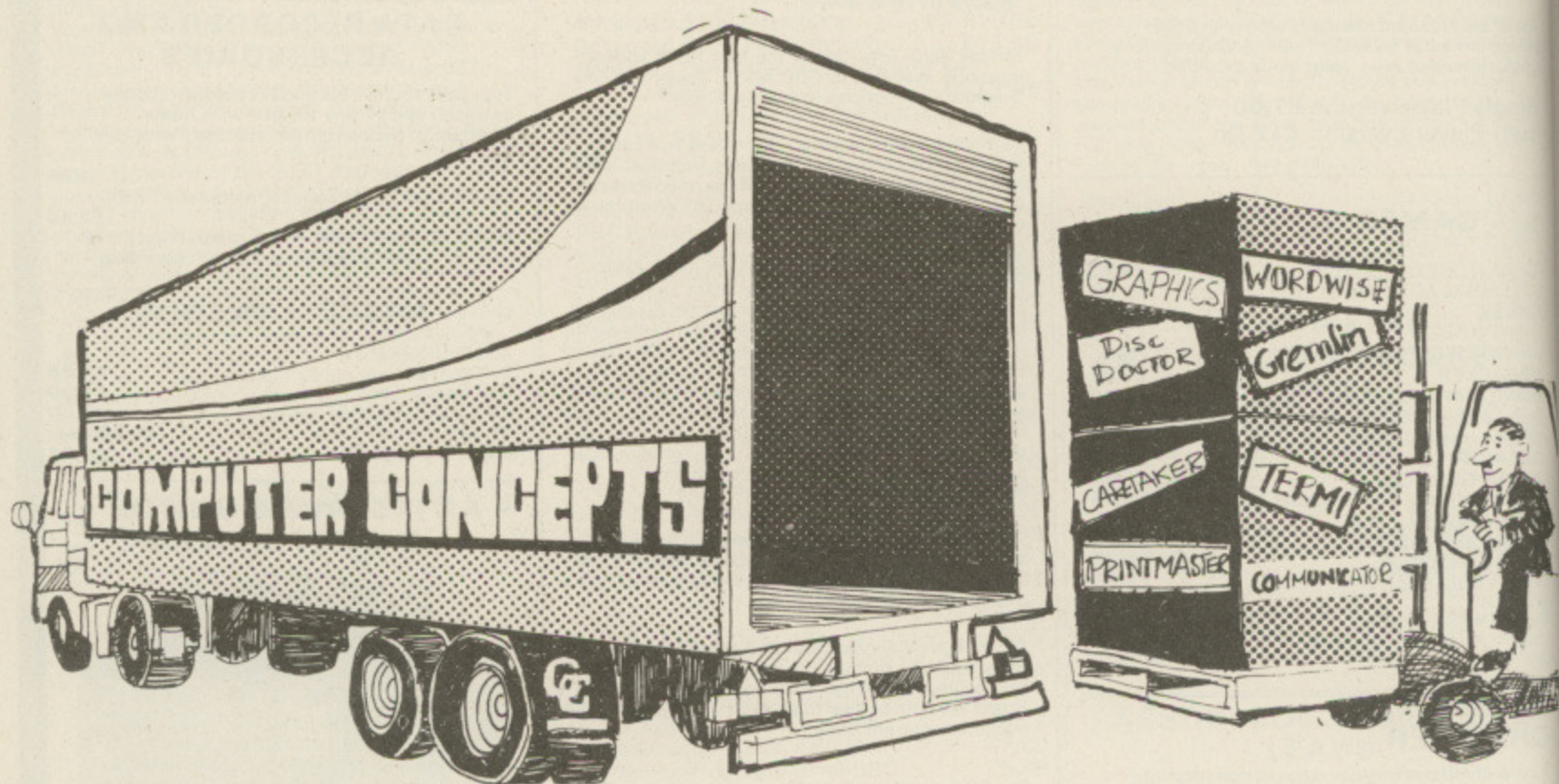

To Gaddesden Place, Hemel Hempstead, Herts HP2 6EX
Telephone: (0442) 63933
On the 1st August 1984

*Computer Concepts are still expanding and require more machine code
programmers with experience of Z80/6502 processors.*

For further details of vacancies write to:

*The Manager
Computer Concepts
Gaddesden Place
Hemel Hempstead
HERTS HP2 6EX*

Use your head... let DATA take the pain out of programming



SO far in this series we've looked at two ways to get information, or data, into programs.

We can use the brute force approach of assigning data directly to variables, as in:

```
10 number% = 5
```

Another way we've looked at is to teach the micro the information we want using INPUT or GET\$. Here's one example:

```
10 INPUT "How many", number%
```

Let's consider a real case. Suppose we wanted to write a calendar program. We'd want the program to "know" the days of the week:

```
10 REM PROGRAM I
20 MODE 6
30 DIM day$(7)
40 FOR loop%=1 TO 7
50 INPUT "Day of week", day$(loop%)
60 NEXT loop%
70 PRINT "The days of the week
are : - "
80 FOR loop% = 1 TO 7
90 PRINT day$(loop%)
100 NEXT loop%
```

Program I shows how we do this via our "teaching" method, inputting the data into the array *day\$*().

As you'll see when you run it, this is mind-achingly boring. And it's irritating to have to tell the program the days of the week every time you switch on.

```
10 REM PROGRAM II
20 MODE 6
30 DIM day$(7)
40 day$(1) = "Sunday"
50 day$(2) = "Monday"
60 day$(3) = "Tuesday"
70 day$(4) = "Wednesday"
80 day$(5) = "Thursday"
90 day$(6) = "Friday"
100 day$(7) = "Saturday"
110 PRINT "The days of the week
are : - "
120 FOR loop% = 1 TO 7
130 PRINT day$(loop%)
140 NEXT loop%
```

Program II uses the brute force approach. Lines 40 to 100 assign each one of the variables directly.

It's a pain to type in though, isn't it?

Notice, however, that Programs I and II do exactly the same thing, though in different ways.

In programming you'll generally find there are several possible solutions to a problem. As in life, it pays to consider them all rather than rush out on the first one that occurs to you.

Take, for example, the simple assignment of variables for the day of the week.

You might, with some logic, have decided on:

```
sunday$ = "Sunday"
```

```
monday$ = "Monday"
```

and so on.

The days of the week are ordered, so a subscripted variable seems appropriate. It also makes the program more easily adaptable – *maintainable* is the jargon – if we suddenly go onto an eight day week.

A more realistic advantage of the choice of subscripted variables is that we can use it to solve our "getting data into programs" problem more elegantly.

```
10 REM PROGRAM III
20 MODE 6
30 DIM day$(7)
40 FOR loop%=1 TO 7
50 READ day$(loop%)
60 NEXT loop%
70 PRINT "The days of the week
are : - "
80 FOR loop% = 1 TO 7
90 PRINT day$(loop%)
100 NEXT loop%
110 DATA Sunday, Monday, Tuesday,
Wednesday, Thursday, Friday, Saturday
```

Take a look at Program III. Again it does exactly what the two previous programs did, but its way of getting data into the array *day\$* is far subtler.

Lines 50 and 110 do the trick.

Let's look at line 110 in detail:

```
110 DATA Sunday, Monday, Tuesday,
Wednesday, Thursday, Friday, Saturday
```

This contains the data we want to teach the program. More technically, line 110 contains the data we want to

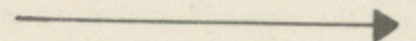

From Page 47

assign to the elements of the array *day\$*.

So, not inappropriately, the line starts with the keyword DATA followed by the data we want, separated by commas.

What happens is that as soon as we run a program, the micro looks through it and makes a list of every item of data to be found in the DATA statements.

This list is maintained in strict order, the first item encountered being the first in the list, and so on.

So far, so good, but how does the data get into the array?

Well, lines 40 to 60 do this. Line 50 is in a loop, with *loop%* being the loop variable. So when the micro first encounters line 50 it is told to:

```
READ day$(1)
```

READ tells the micro to get an item from the list of data it has made, and assign it to the following variable.

The item of data it picks is the first one on the list that hasn't been read already.

So the first time through the loop, on encountering line 50, *day\$(1)* will have *Sunday* read into it.

Next time through the loop, *loop%* will have the value 2, so *day\$(2)* will have *Monday* read into it. Remember, the micro picks the first *unread* item of data.

It's not hard to see that this will continue until all the seven days have been read in. I think you'll agree, it's a much neater solution to our problem.

Lines 70 to 100 then print out the days of the week for us and the program ends.

You're perhaps thinking that line 110 might play some part when the program drops through into it from line 100.

However, it's already had its day, being read at the beginning of the program, and so plays no further part.

When you think about it, this means that the DATA statements can appear anywhere in a program.

Try deleting line 110 and re-entering it as another line – say line 35. As you'll see, the position of the DATA statement in the program makes no difference. Careful use of the Copy key will save a lot of work here.

While you're at it, try leaving, say, Saturday off the DATA statement so that when the program tries to read *day\$(7)*, it has no data in the list for it. Observe and take note of the resultant

error message.

When the micro's busy making up its list it ignores any spaces in front or behind items of data.

If you want a word to be preceded by, say, three spaces, you can force the micro to accept the spaces by putting the item, including spaces, in quotes. For example:

```
1000 DATA " word", " space"
```

The micro will omit the quotes when it's making up its list of data, in much the same way that it omits them in:

```
A$ = "Test"  
PRINT A$
```

The above results in the word Test appearing on the screen, not "Test".

```
10 REM PROGRAM IV  
20 MODE 6  
30 FOR loop% = 1 TO 9  
40 READ data$  
50 PRINT data$  
60 NEXT loop%  
70 DATA first,second,third  
80 DATA first, second, third  
90 DATA " first", " second",  
third"
```

Running Program IV and thinking about the results should make things clearer.

Items in DATA statements don't have to be strings, though. They can just as easily be numbers. You must, however, make sure that numbers are read into numeric variables, and strings into string variables.

The fact that we separate items in data strings with commas can make life a little awkward, especially with numbers. 100,000 may mean one hundred thousand to us, but in a DATA statement it's two separate items, 100 and 000.

If you really insist on those commas, you have to put the thing in quotes, and treat it as a string.

You may be wondering how the micro keeps track of the next item of data to be read.

It does this by keeping a pointer – its own sort of variable.

One way to think of it is that the pointer holds the number of the item in the list that is the next to be read.

Once that data item has been read, it then increases the pointer by one, so that it points to the next free item on the list. Of course, at the beginning of the

program, the pointer would be pointing to the first piece of data.

Now you can fiddle with this pointer and, by making it point to various parts of the list, the micro can read items of data it has already read. This means you can read more items of data than you've got.

The important keyword here is RESTORE. In Program V line 80 holds the magic word.

Whenever the micro encounters RESTORE, it changes the pointer so that it points to the beginning of the list of data items.

The effect is that the micro will begin reading from the head of the list again. Sometimes this comes in handy – especially when it saves you typing in lists of data twice.

The main part of Program V is an infinite REPEAT...UNTIL loop.

First time through, line 50 reads *over* into *data\$(1)* and *and* into *data\$(2)*. Notice, you can READ more than one item at a time, by separating the receiving variables with commas.

Lines 60 and 70 then print them out. Line 80 RESTORES the data pointer to the beginning of the data list.

This means that when we are forced to do the loop again by line 90, line 60 has some data to read – *over* and *and* once again.

Thus the program will continue to print out *over* and *over* and *over*.

```
10 REM PROGRAM V  
20 MODE 6  
30 DIM data$(2)  
40 REPEAT  
50 READ data$(1),data$(2)  
60 PRINT data$(1)  
70 PRINT data$(2)  
80 RESTORE  
90 UNTIL FALSE  
100 DATA over,and
```

Incidentally, RESTORE makes the micro start at the beginning of the data list whether it has reached the end of the list or not. To prove this, change line 100 to:

```
100 DATA over,and,extra
```

As you'll find, *extra* is never read.

That's all for this month. Next month it's random numbers and how procedures can help you write better programs.

M I C R O P O W E R M I C R O P O W E R M I C R O P O W E R



GET ON THE RIGHT TRACK WITH MICRO POWER

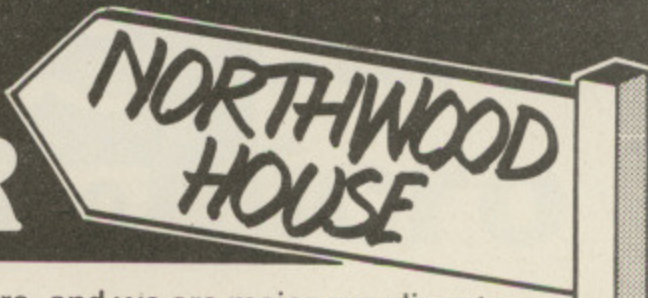

Micro Power are an official service and information centre, and we are major suppliers to Government and educational establishments. We stock the complete range of Acornsoft and Micro Power software as well as a wide range of B.B.C. Micro and general computing books. Our expert staff are always on hand to provide advice and assistance in the relaxed atmosphere of our showroom.

COMPUTERS

SUMMER SPECIALS	
B.B.C. Micro + Cassette Recorder AND Five Micro Power or selected Acornsoft Tapes	399.00
B.B.C. Model B plus DFS + 4 tapes	469.00
B.B.C. Model B plus Econet + 4 tapes	446.00
B.B.C. Model B plus DFS and Econet	516.00
Acorn Electron + Cassette Recorder OR Five Micro Power Tapes	199.00

MONITORS

Kaga 12" Green Screen	123.05
Ferguson TX Monitor/TV	335.95
Sanyo DM2112 12" Green Screen	74.95
Microvitec 14" RGB/PAL and audio output	258.75
Microvitec monitor (plastic)	286.85
Microvitec monitor (metal)	228.85
Plinth for above	5.75

DISK DRIVES

Pace 40 track 100K	156.40
Pace 40 track double sided 200K	220.80
Pace 40/80 track double sided 200/400K	241.50
Pace 40 track dual drive 200K	310.50
Pace 40 track double sided dual drive 400K	434.70
Mitsubishi 40/80 track double sided dual drive 400/800K	567.85
Torch Z80 Disk Pack 80 track double sided dual drive (including Perfect software)	803.85
AMS HFD 3055 3" 100K	199.00

ALL PRICES INCLUSIVE OF V.A.T.
We provide free fitting for all firmware.

PRINTERS

Epson FX80	416.40
Epson RX80 F/T	268.90
Juki 6100 Daisywheel	375.00
Smith Corona TP-I daisywheel	270.20
Cannon PW1080	332.58

ACCESSORIES

Acorn B.B.C. cassette recorder (inc. leads)	35.00
Morwood B.B.C. cassette recorder (inc. leads)	29.95
Sureshot self-centering arcade joystick	18.22
Micro Power potentiometer joystick	12.95
Acorn Disk Interface (Free 1.2 ROM if req.)	97.00
1.2 ROM upgrade	11.50
Speech synthesiser plus cartridge socket (Free 1.2 ROM if required)	55.00
View wordprocessor ROM	59.80
Wordwise wordprocessor ROM	45.42
Electron Plus 1 printer/joystick interface	59.90
First Byte Electron joystick interface (including cassette)	24.95
ATPL sideways RAM board	45.00
Teletext adapter (Free 1.2 ROM if req.)	225.00
Softlight EPROM programmer	75.90
Printer cables (parallel or serial)	15.50
System Sac (B.B.C. canvas carrying case)	19.95
3M unlabelled disks (ten)	15.00
Scotch D/S D/D disks (Box of ten)	32.50
Maxell 3" disk	4.95
Disk storage case	19.95
Vinyl dust cover for computers, disk drives, monitors and printers	4.50
Stack light pen	28.75
Tutor Mate Monitor stands	10.50

Wide selection of computer leads and printer ribbons in stock.

ALL ROADS LEAD TO MICRO POWER!

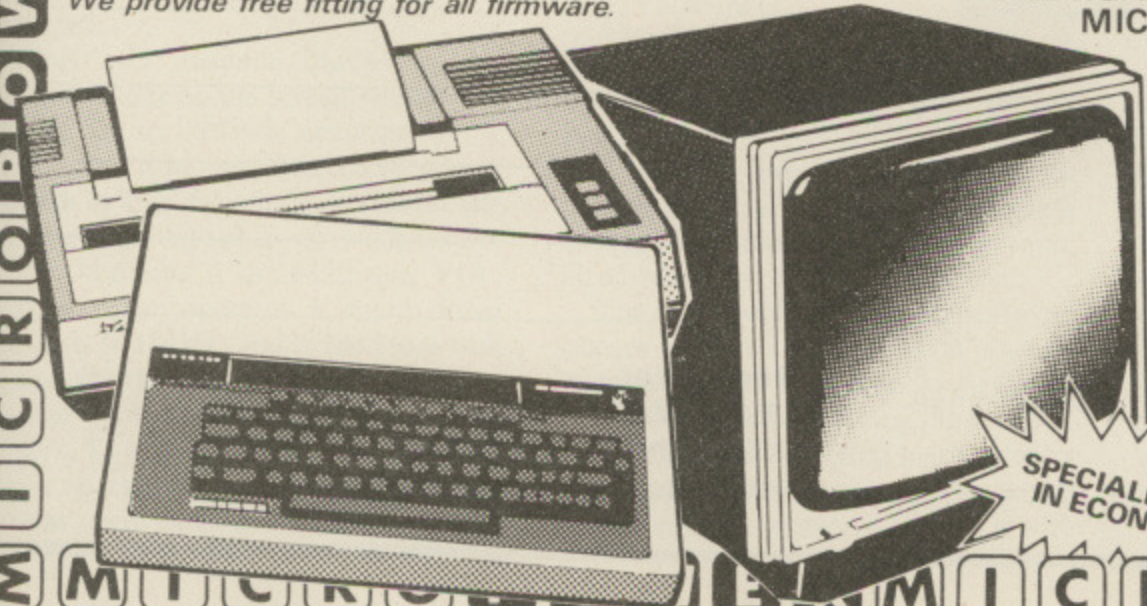

*HP facilities available. Please contact us for further details.

*Free parking. All prices correct at time of going to press.

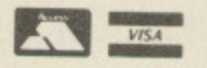

Showroom: MICRO POWER LTD., Northwood House, North Street, Leeds LS7 2AA; Tel: (0532) 458800
Mail Order: MICRO POWER LTD., Dept. MU9, Sheepscar House, Sheepscar Street South, Leeds LS7 1AD; Tel: (0532) 434006

Send an SAE for our complete listing of hardware, software and books.

CARRIAGE FREE for ALL hardware
Books and software only 55p per order
U.K. Mainland Only

SPECIALISTS IN ECONET

M I C R O P O W E R M I C R O P O W E R M I C R O P O W E R

GSL

COMPUTING

SPECIAL PRICES

DISK DRIVES

3" Mini Floppy 100K Disk Drive
(Cased with Leads and Utilities Disk)

Price Ex-VAT
£130.00

5 1/4" TEC 100K Disc Drive

£130.00

PRINTER

NEC 8023 80 Dot Matrix Printer

£250.00

MICROCOMPUTER

Acorn Electron

£173.04

MONITOR

DECCA 1231 Colour Monitor

£190.00

GSL's Product Range Includes:

Winchester Hard Disk System · Cartridge Drives for backup · 64K
Printer Buffer · Low Speed Logic Analyser · Real Time Calender
Clock · Analogue Signal Analyser · Alternative Keyboard Display
Rack Mounting System

I would like to order:
(Please tick)



- 3" 100K DISK DRIVE
- 5 1/4" 100K DISC DRIVE
- NEC PRINTER
- ACORN ELECTRON
- DECCA MONITOR
- Send me information on your product range

(Cheques made payable to G.S.C.L.)
Or Phone LEA WYATT ON ANDOVER (0264) 59633

NAME _____

COMPANY _____

ADDRESS _____

Tel: No. _____

Return to:
LEA WYATT GSCL
WEST PORTWAY, ANDOVER,
HANTS SP10 3SG

MU10

THE BB
resolution
use of tw
Each c
the eight
counting
VDU 19
colours a
one time
When
VDU19
system u
soon as
This c
display if
and over
There
Every fi
displaye
refreshed
If the
for the n
screen d
would ne
would o
The p
of the st
program
since the
fiftieth o
come to
waiting
Howe
colour r
the scre
advanta
several
"same"
In Pr
eight ba
in Mod
The
know w
when to
Now
by inte
Once th
must b
interrup
which
change
This
chosen
timing
As t
refresh
only t
accurat
This
process
suited f
The
timers,
as its o
We

THE BBC Micro in Mode 0 offers high resolution graphics but only allows the use of two colours.

Each colour can be changed to one of the eight available on the BBC – not counting flashing colours – by using the VDU 19 command, but still only two colours are allowed on the screen at any one time.

When a colour is changed, using the VDU19 command, the operating system updates the colour register as soon as the command is issued.

This can produce a rather flickering display if the command is repeated over and over again in close succession.

There are ways around this, however. Every fiftieth of a second the picture displayed on the screen is updated, or refreshed.

If the operating system itself waited for the next "vertical sync" – when the screen display is refreshed – the display would not flicker since the colour swop would occur at the changeover.

The problem with doing this as part of the standard OS is that the speed of program execution would be slowed, since the display is refreshed only every fiftieth of a second. The program would come to a stop at every VDU 19, waiting for the next sync.

However if you could change the colour registers at regular intervals as the screen is updated you have the advantage of being able to display several colours on the screen at the "same" time, even in a two colour mode.

In Program I, we set out to display eight bands of colour across the screen in Mode 0.

The main problem with this is to know when the vertical sync occurs and when to change the colour register.

Now the vertical sync can be trapped by intercepting event number four. Once this event has occurred a timer must be set up which will cause an interrupt at regular intervals, during which the colour register can be changed.

This will produce blocks of the chosen colour on the screen, though the timing has to be fairly accurate.

As the time between each screen refresh is one fiftieth of a second the only timer capable of such short accurate timing is the 6522 user VIA.

This timer operates a count down process at 1MHz, and is therefore well suited for the problem.

The VIA actually consists of two timers, T1 and T2. We shall be using T2 as its operation is easier to understand.

We must enter a start time into T2

Extra colours for your BBC Micro

and then trap the interrupt generated when the counter has decremented to zero. At this moment we change the colour being displayed and then initiate the next timed countdown until the eight colours we require have been displayed.

T2 consists of a low and high order counter. When the high order counter is loaded the timer begins to decrement at 1MHz.

Before the timer can be used we must

By
KEVIN EDWARDS

select the timed interrupt mode and enable T2 to generate interrupts when it times out.

After this we just load in the low and high order counter and on doing so the timer will begin decrementing. When the eight colour blocks have been displayed we must disable any further T2 interrupts.

The interrupt generated by T2 passes through IRQ2V at locations &206 and &207. To check that the interrupt generated is by T2, we must check that bit five of location &FE6D is set. This bit is set only when T2 has timed out.

To do this, we change IRQ2V to point to a short routine which checks if this is true. Next we allow the interrupt to be handled back to the operating system.

The vertical sync is trapped by altering the event vector and enabling event four, which occurs at each vertical sync.

When this event has occurred we initiate the timer to generate interrupts at regular intervals, producing equal sized bars of colour on the screen.

The only problem is that vertical sync occurs when the electron beam is on its re-trace period. Therefore the first part of the timing is done during the re-trace, resulting in the top band being smaller than the others.

The colour register, or palette, is a 64

bit RAM located in the video ULA. This defines the relationship between the logical and actual colours displayed on the screen.

By altering this palette we can change the colours displayed on the screen. The palette is located at location &FE21 and consists of two nibbles.

The most significant nibble is the logical colour register and the lower nibble is the actual colour register. By altering these in the correct order we can reprogram any of the colours displayed on the screen.

Changing the colour register in any of the two and four coloured modes is rather complex. After changing one logical colour, the other logical colours must also be reprogrammed to their previous "actual" colour.

Program I shows all this in practice. When run, the eight colour blocks will be displayed on the screen. The *FX14,4 command at the end of the program enables event number four.

To disable event four, you enter *FX13,4. Entering VDU20 will then restore the colours to normal. The same effect is produced in any mode other than Mode 7 – try it and see!

The colour bars appear to shift slightly. This is owing to higher priority interrupt passing through IRQV1 being serviced first. It means that the routine has to wait until the more important interrupt has been serviced before it can update the colour register.

A word of warning. The program alters the interrupt vector. Therefore running it twice without restoring the old vector's value will cause the computer to crash.

For this reason you can see it is advisable to save the program before running it in case anything has been entered incorrectly.

The original vector table can be restored simply by pressing Break then typing OLD to retrieve the program.

PROGRAMMERS' WORKSHOP

From Page 51

```

10 REM EXTRA COLOURS
20 REM Requires 6522 User VIA
30 REM By Kevin Edwards
40 REM (c) Micro User
50 FORL=0T02STEP2:P%=&900
60 [OPTL
70 .Change_irq2v_vector SEI\ Disa
ble interrupts while changing vector
80 LDA&206:STA&70:LDA&207:STA&71\
Save old vector address
90 LDA#Interruptoccurs MOD 256:STA
&206\ Change vector to point to new
routine
100 LDA#Interruptoccurs DIV 256:STA
&207
110 CLI:RTS\ Enable interrupts and
return back to BASIC
120 .Interruptoccurs PHA:TXA:PHA\
Save A and X on stack
130 LDA&FE6D:AND#32:BEQExit\ Check
if T2 has caused interrupt
140 .Label1 DEC&74:LDA&74:AND#7:STA

```

```

&72\ If so then update colour regist
er
150 LDA#0:STA&73:CLC:ADC&72:STA&FE2
1
160 LDX#7
170 .Label2 LDA&73:CLC:ADC#16:STA&7
3:ADC&72:STA&FE21\ Change colour reg
ister
180 DEX:BNELLabel2
190 LDA&74:BEQExit\ Check to see i
f all 8 blocks have been displayed
200 JSRSetup_6522:JMPExit1\ If not
then set up timer for next block
210 .Exit LDA#&20:STA&FE6E\ If all
blocks have been displayed disable T
2 interrupts
220 .Exit1 PLA:TAX:PLA:JMP(&70)\ R
estore A and X and jump back via old
interrupt vector
230 .Setup_6522 LDA#&DF:AND&FE6B:ST
A&FE6B\ Select timed interrupts for
T2
240 LDA#&A0:STA&FE6E\ Enable T2 in
terrupts
250 LDA#0:STA&FE6B:LDA#7:STA&FE69:R

```

```

TS\ Load countdown time into T2 coun
ters, low then high order
260 .If_an_event_occurs CMP#4:BNEEn
d\ Check to see that event is a vert
ical sync
270 JSRSetup_6522:LDA#8:STA&74\ If
it is then set up timer and set numb
er of blocks to be displayed to 8
280 .End RTS\ Return back to event
handling routine
290 JNEXT
300 CALLChange_irq2v_vector
310 ?&220=If_an_event_occurs MOD256
320 ?&221=If_an_event_occurs DIV256
330 ?&74=0
340 MODE0:FORL%=1T030STEP3:VDU31,10
,LX:PRINT"This is in mode 0 .....
." :NEXT
350 *FX14,4
360 END

```

This listing is included in this month's cassette tape offer. See order form on Page 217.



BBC



ELECTRON

LEAVE REALITY BEHIND YOU WITH...

MP ADVENTURE GAMES

A new range of REAL-TIME ADVENTURES we believe the most advanced available for the BBC & Electron: intelligent characters that will move around independently, multiple command statements, advanced text compression methods allow even more detail.

*****NEW*** SADIM CASTLE** It is said that those who enter the haunted estate of Sadim Castle do not return! Long ago tragedy struck here and since then many people have died in mysterious circumstances. Can you uncover the secret and break a terrible curse!!

*****NEW*** VALLEY OF THE KINGS** Far away across the desert lie the lost pyramids of Kaculud, rumoured to contain fabulous treasure and a legendary golden mask. The pyramids may now have been discovered although strange happenings have caused the archaeologists to abandon their camp. Your task is to find the golden mask.

Further titles coming shortly: CROWN OF MARDAN, THE FALLEN EAGLE.

Our original and popular text adventures are also available: FIRIENWOOD, WOODLAND TERROR, BLUE DRAGON, SURVIVOR. Please send for full details.

Text Adventure Prices: £7.50 (Cass) £10.50 (Disc) including VAT & postage with UK. State which machine when ordering. Dealer enquiries welcome.

MP SOFTWARE LTD.

165 Spital Road, Bromborough, Merseyside L62 2AE.
Tel: 051-334 3472



THE PRINTED WORD

LOW PRICES

TOP SERVICE

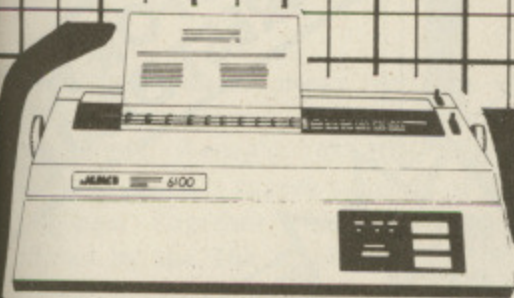

JUKI 6100

One Year Warranty
 20 CPS : BiDirectional & Logic Seeking
 10, 12, 15 & Proportional Spacing
 Wordstar Compatible
 2K Buffer : 13 Inch Platen
 Underline : Backspace + Lots more
 Centronics Interface Standard
 RS 232 Interface £54.00 + VAT Extra
 Tractor Feed £99.00 + VAT Extra
 Single Sheet Feeder £238.00 + VAT Extra

JUKI 6100 £330.43 + VAT = £380.00

BBC/ORIC or DRAGON Package
JUKI 6100 + CJE PRINTER PACKAGE
£400 Inc. VAT

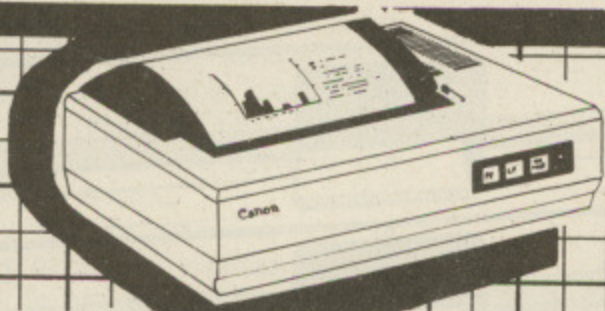

CANON PW-1080A

Near letter Quality Printer

NLQ Mode 23 x 18 Matrix: 27 cps
 Draft Mode 11 x 9 Matrix : 160 cps
 Full range of Epson FX 80 Print Codes
 Friction & Tractor Feed
 Centronics Interface Standard
 CANON PW-1156A (Accepts 15" Paper) Available

CANON PW-1080A £278.26 + VAT = £320

CANON PW-1156A £360.00 + VAT = £414.00

PACKAGE PRICE for BBC MICRO/DRAGON/ORIC
CANON PW-1080A C.J.E. PRINTER PACKAGE £345 Inc. VAT
CANON PW-1156A C.J.E. PRINTER PACKAGE £439 Inc. VAT

Special RS 232 Printer Bargain
STAR DP8480 (8" Printing) £187.00 Inc VAT
 Ideal for BBC/Newbrain/HX20 & Spectrum Int. 1
 Phone for full specification

C.J.E. Micro's BBC Printer Packs

For Star, Canon & Juki Printers include:

1. The Printer
 2. Delivery by Securicor
 3. Cable to the BBC 1.3 Metres
 4. Screen Dump Program (M/C Source)
 5. Text Dump Program
 6. Function Key set up Program. For use with WORDWISE
 7. Function Key Label Printing Program. For use with above.
 8. VIEW Printer Driver
 9. 100 Sheets of Paper
 10. Mains Plug with 3 Amp Fuse
 11. Booklet giving details of using the printer with a BBC.
 12. Character Defining Program for Downloadable-character-set
- C.J.E. Printer Packs for other micro's include:-
 Printer, Cable, Paper, Mains Plug & Delivery

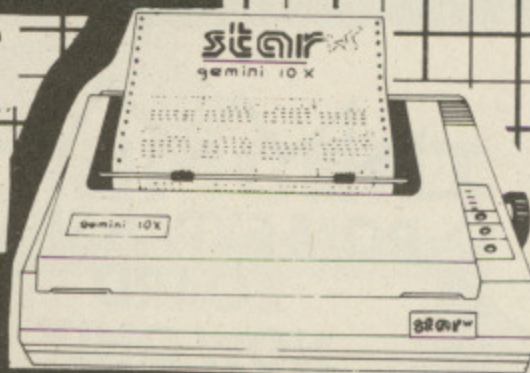

STAR GEMINI 10X

One Year Warranty
 True Descenders 9 x 9 Matrix
 120 CPS Bidirectional & Logic Seeking
 40, 48, 68, 80, 96, 136 cpl
 Italics, Emphasized, Double strike,
 Super & Sub Scripts
 Downloadable Character Set
 Hi-Resolution & Block Graphics
 Friction or Tractor Feed
 10 X 10" Carriage, 15 X 15" Carriage
 Centronics Interface Standard
 RS232 Int. £52.00 + VAT Extra

Gemini 10X £235.00 Inc VAT
Package for BBC/DRAGON/ORIC
GEMINI 10X + CJE Printer Pack £255 Inc. VAT
Star Gemini 15X £380 Inc. VAT

STAR DELTA 10
SPEC. AS FOR 10X PLUS:-
160CPS: 8K BUFFER
CENTRONICS + RS232 INT'S STD
£311.30 + VAT = £358.00

BBC MICROMODEL B £399.00 Electron £199.00

BBC Micro Model B with Disc Int. £469.00

Large Range of Accessories including Disc Drives, Printers, Monitors always in stock.

Printer Cables

BBC to 36 Way Centronics Type Connector £15.00
 Dragon to 36 Way Centronics Type Connector £15.00
 Oric to 36 Way Centronics Type Connector £15.00
 Torch to 36 Way Centronics Type Connector £20.00

Serial Printer Cables

BBC to 25 way D type £9.50
 EPSON HX20 to 25 way D type £9.50
 NEWBRAIN to 25 Way D Type £12.00
 25 way D type to 25 way D type £15.00

Blank C15/C30 Cassettes Ten for £4.50 ANY MIX
 Send SAE for Full Price List

VAT INCLUDED WHERE APPLICABLE
PHONE/CREDIT CARD ORDERS WELCOME
 Postage 50p per order or as stated
 24 Hr Securicor Delivery
 for Printers/Disk Drives £8.00
 (SHOP/WORKSHOP CLOSED MONDAYS)

C.J.E. Microcomputers

Dept (MU), 78 Brighton Road, Worthing
 W. Sussex BN11 2EN (0903) 213900

EXPORT ORDERS WELCOME

RING FOR SAMPLE PRINTOUT, FULL SPECIFICATIONS & LATEST PRICES
BEST PRICES & BACKUP ON THE STAR JUKI & CANON PRINTERS

PHONE FOR YOUR
NEAREST DEALER

ROM EXPANSION
BOARD
NOW ONLY
£45

DOUBLE
DENSITY
CONTROLLER
FROM £95

EPSON
DISK DRIVES
FROM £199 RRP

ADD-ONS TO HELP YOUR BUSINESS TAKE OFF.

If you are thinking of upgrading your BBC Micro, it makes sense to get add-ons that not only bear a reputable name but also have been designed specifically to be used in conjunction.

EPSON, manufacturers of the world's best printers, now bring you the world's best drives, including the industry standard 3½ inch and 5¼ inch 40 and 80 track units.

These units are assembled in Britain by UDM for distribution through a dealer network.

All prices plus VAT

The Double Density Controller has been developed and manufactured by UDM specifically for the EPSON Disk Drives effectively doubling their capacity whilst maintaining compatibility with

- second processors
- teletext
- OSWORD 7F.

Additionally, a sideways ROM expansion board has been developed that is fully compatible with the above.

Send for full details of range available and prices or ring for your nearest dealer

EPSON & UNITED DISK MEMORIES

Stanhope House Fairbridge Road London N19

01-263 5026

IN comparison to many versions of Basic having around 50 or so available commands, Acorn's 16k BBC Basic ROM presents a superb superset of the language. Together with the facilities offered by the 16k machine operating system, the BBC Micro certainly has an extensive command set.

In all there are about 120 keywords in BBC Basic plus around a dozen operating system *commands (with a possible 18 more if a DFS is installed), 31 VDU codes, three indirection operators and 156 other *FX CALLS.

Why on earth should anyone want even more programming commands?

When developing programs in Basic the writer is often in need of information at different stages of the program concerning memory usage, variables used and their contents, states of the function keys, character definitions, filing systems in use, and so on.

The programmer may also want easily to edit parts of the program, altering lines or variable names and subsequently removing much of the spaces and comments used in the developmental stages.

It may also be necessary to join separate programs or routines together or try out the program at various places in memory.

Furthermore the current status of buffers, sideways ROMs or peripheral devices and invoked OS calls may need to be assessed without getting involved in machine code.

This review therefore concerns a number of chips which are primarily collections of Basic programming aids for the BBC Micro. Some also have additional features such as extended graphic commands or machine code monitors. The major facilities are listed in Table I and explained below, followed by a few comments on each chip.

Memory usage: A very useful facility which should provide information on the current status of memory, for example program length, memory used by variables, amount of free memory and reserved memory and the location of PAGE, LOMEM, HIMEM, TOP, VARTOP.

I use this sort of facility regularly during program development and was surprised to see it available on only four of the chips.

This feature was almost fully implemented on ToolkitB, Caretaker and ToolkitD and poor on Addcomm, though the latter did give its limited information in both decimal and

THE MAGNIFICENT

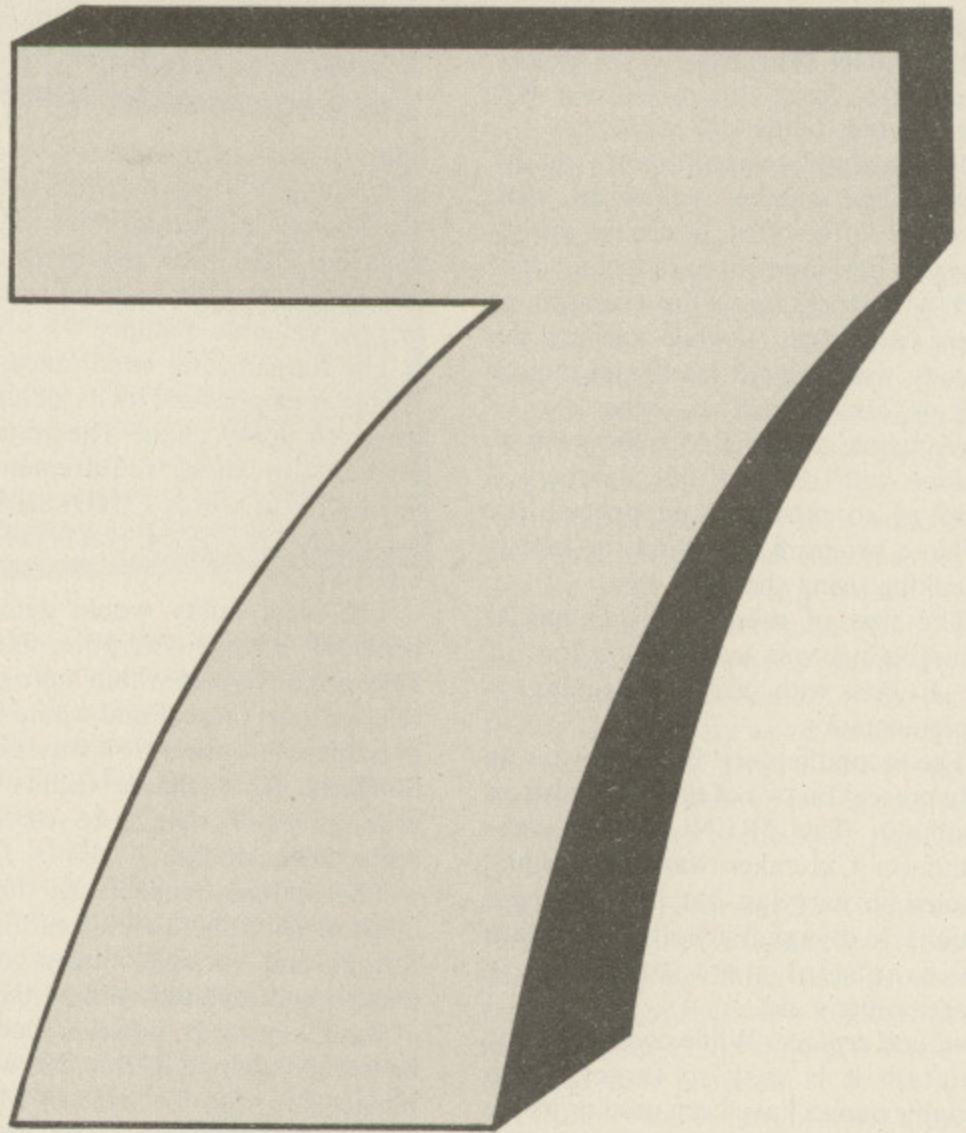

Seven Toolkit ROMs for the BBC Micro compared by MIKE MAHON

hexadecimal and gave the space used by variables without the user having to resort to subsequent calculations.

ToolkitD included the range occupied by the program, variables, free RAM and also any space reserved by the user. (Note that the space reserved for variables is only known by any of these chips after a program has been run.)

Without doubt the best feature in this area was *HELP INFO on ToolkitB. This offered the above type of information as with *FREE but additional information on the current status of @%, LISTO, WIDTH, error messages and more than half a dozen of the low value *FX commands – an extremely thoughtful facility.

Function keys editor: Although programming the user definable function

keys on the BBC is relatively easy, displaying their contents and editing them is cumbersome.

A utility to display their contents, or the contents of a selected key, to edit them, clear them and also indicate how much room is left in their area in PAGE & B00 would be useful. An optional preset function key set of commonly used routines would also be welcome.

Again, only four of the ROMs supplied function key commands, and these were rather limited allowing only visualisation and editing of their contents. Caretaker was unique and useful in allowing for the direct saving and loading of function key definitions, but unfortunately had none of the other facilities mentioned above.

Renumber/move lines: BBC Basic

From Page 55

already has a renumber command – not present in most other Basics – which allows whole programs to be renumbered after specifying a starting line number and the desired increment.

This facility intelligently sorts out the GOTO line number values as well. However it is often desirable during program development to renumber only part of a program – for example, to insert extra lines – while keeping the already well ordered remainder intact.

It is also sometimes necessary to move whole sections of a program to regions with different line numbers – such as to move whole procedures within a program – without the labour of editing using the copy key.

The first of these facilities, partial renumbering, was available on four of the ROMs with varying degrees of implementation.

The second feature, block move, was only present on two of these and also on ToolkitD. The *RENUMBER command on Caretaker was fully implemented in carrying out both of these actions. In my opinion both facilities are an essential part of a Basic programmer's aid.

Find and replace: While coding a Basic program it is easy to forget which variable names have been used or where they appear within a program. The programmer, or user trying to follow someone else's program, may wish to seek out all occurrences of, or lines containing, a particular string or Basic keyword.

Furthermore, when debugging a program it is often found that variations in the spelling of a variable or procedure name are the cause of much trouble and need to be readily amended. Also the

Toolkit (Beebugsoft)

*This is an excellent Basic programming aid with easy to use, and easy to remember, commands and good documentation. Its best feature without doubt is its very informative *H.INFO command, though its menu of "find" utilities was also very good. There are some areas for improvement, especially in its cross-reference and variable dump features.*

Other useful utilities offered on this chip are a memory dump, screen save and Commodore style screen editor.

Addcomm (Vine Micros)

This was not really up to the mark as a first division toolkit chip. A number of features were either missing or poorly implemented. However its forte was the wide range

of new graphics commands and Logo like statements included on a chip, along with programming aids.

Overall, this chip still represents good value for money. (See more detailed review on Page 140.)

final versions of programs – are there such things? – may require variable names or certain strings to be altered or replaced. This latter requirement may help in reducing the length of a program to save valuable memory.

The fundamental importance of this facility is emphasised by its inclusion on all seven utility chips. The commands relevant to these requirements are related to the words FIND, SEARCH, REPLACE, EXCHANGE and CHANGE.

The ideal utility would detect any type of string, variable name or keyword anywhere within a program or selected part thereof and would include a wildcard option for misspellings. Similarly, the exchange facility should also offer a selective or global replacement option.

The options available on the seven chips reviewed here varied enormously. Strings and variable names could be located and replaced with all the chips. Basic keywords, however, could also be located with all ROMs, but were not replaceable with Toolstar or Molitool. In addition, locating Basic keywords with Caretaker and Aids II was fussy as the numeric tokens or complex codes were needed.

On Addcomm, Toolstar, Molitool and ToolkitD you simply type in the Basic keyword. On ToolkitB it is preceded by the £ character.

All the chips except Molitool and ToolkitD offered a wildcard facility in the search string, and this was particularly extensive on Caretaker.

When searched strings, etc, had been located, the utilities responded either by listing the respective line number only (Molitool, Caretaker), by listing the lines and contents (ToolkitD, Caretaker) or by listing the lines and highlighting the particular string (ToolkitB, Addcomm, Toolstar, Aids II) – the latter option being the most useful.

The utilities also varied somewhat in specifying the amount of the program which could be searched or replaced from global to selective range or individual lines or a mixture of each.

The replace feature was most versatile roughly in the order Addcomm, Aids II, Caretaker and

Toolstar, where individual lines could be viewed before deciding whether to replace or not. The latter option was not readily available on the other three chips.

Cross reference and variable dumps: A completely implemented cross reference utility would list against every variable and every keyword and every reference to a line number within a program, the line number at which they occurred.

None of the chips had such a utility, though Molitool was nearest with its *VLIST command which cross refer-

Caretaker (Computer Concepts)

Another excellent example of a Basic toolkit ROM, certainly first division stuff. A number of features are better implemented than on Beebugsoft's Toolkit though they are slightly more difficult to use and remember. Reference to the well written manual, however, leaves no problems in getting the commands to work.

This chip also has facilities for switching the cursor on or off, setting tabstops and single key entry of keywords (an Electron emulator!). I still wonder why there is no verify command though.

enced all variables within a program, thus saving repetitive use of the FIND utility.

ToolkitB made a slight indent in this way with its commands for listing the lines at which functions and procedures occurred and Caretaker was able to show which procedures had been used.

One of the essential needs while debugging a program is to know the current contents of variables used. Thus one would expect any programmer's aid worth its salt to have a variable dump utility for this purpose.

Ideally it should be possible to select all or any type of variable – real, integer, string or array – and list its contents following a full or partial program run.

Molitool certainly came out best with this facility, as it was the only utility capable of listing the contents of arrays rather than just their dimensions. Its

only limitation was the requirement to dump each type of variable separately. There was no "dump all variables" command.

This limitation was also present on ToolkitB, though it did, like Caretaker, produce the numeric variables contents in both decimal and hexadecimal format. Caretaker, however, allowed for the dump of all variables or a selected type.

In contrast, only the "dump all variables" option was available on Aids II. The variable dump was most limited on Addcomm, which merely listed the variables currently used and not their contents.

I would not buy any chip solely as a Basic programming aid unless it had a decent variable dump.

Shorten program: Free memory in the BBC Micro is usually scarce. Programs are often required to be as short as possible just to fit in the space available, let alone run.

Furthermore, it may be necessary to reduce the length of a program which worked in a cassette-based machine in order to run it on one fitted with a memory-gobbling upgrade such as disc, econet or teletext. Another reason for reducing program length is to make it run more quickly.

Editing out each unwanted space or REM statement and creating multistatement lines is tedious. Therefore a shorten program facility is definitely in the class "every toolkit should have one".

Four of the seven toolkits tested were able to remove unnecessary spaces and/or REM statements. In addition, Addcomm could remove just REM statements.

Only Addcomm, however, allowed selection of the range to be compacted. Unfortunately two chips, ToolkitB and Addcomm, were careless in removing REM lines referenced by GOTO statements.

Only Addcomm and Caretaker had the extra facility of creating multistatement lines to save memory.

Undoubted Caretaker was the most complete program shortener. It is just a pity it doesn't tell you how much memory has been saved when it has done its job.

Lengthen program: Having gone to all the trouble to shorten a program in order to save on memory, the program may have become rather unreadable – especially if many multistatement lines are present. A facility to add extra

Toolstar (Pace)

Both Basic and machine code programming aids are implemented on this chip. Unfortunately with regard to this review the latter far outweigh the former in capabilities. As a Basic utility chip it is not adequate.

*It did, however, have a useful *RESET command and some disc editing/formatting features. Also *CONV allows conversion between decimal, hexadecimal and binary.*

I cannot leave this one without mentioning the manual. It is long (127 pages), comprehensive and full of useful information. The most annoying feature of this utility was that blinking purple star!

spaces and disarticulate multistatement lines is therefore quite helpful, particularly for listings.

All the chips except ToolkitB had some facility for improving legibility. Caretaker, Aids II and ToolkitD allowed whole or selected parts of a program to be listed on screen or to the printer with multistatement lines taken apart, and, in the case of the latter two, with extra screen colours and indents to highlight features.

This process was limited to a specific line on Addcomm, though it could be combined with the find utility to list a whole program in this way.

Molito did not break multistatement lines, but did add spaces to give extra clarity in listings. Toolstar's *FLIST added useful information to the listing for machine code programmers in putting line memory locations in the display.

Aids II and ToolkitD were slightly

Aids II (Softsmith)

A different approach to the others, as most commands are menu-driven. Although many of the Basic programming aids are implemented, and often quite well, too many of the really useful options, such as memory information, function key editor, program shorten and verify, are missing.

These deficiencies and the difficulty to use manual put this in my second division class.

Like Toolstar, this chip does offer the machine code programmer a memory dump and disassembler. Aids II also has the option to set each key to bleep when pressed.

more adventurous with this facility than Caretaker, though the latter was slightly easier to use.

Verify a saved program: BBC Basic is unusual in not having a verify command to check that a saved program will load properly and is a perfect replica of the original still in memory. However only three of the toolkits have rectified this omission.

ToolkitD's version was the weakest and merely responded with "verified" or "verification failure". ToolkitB either "file verified" or "failed at... (hexadecimal address)" following which the program could be checked using the memory editor.

If a file did not verify then Addcomm gave the most useful information in listing the offending Basic line, highlighting the corrupted code and showing the memory location in decimal and hexadecimal. There was a feeling of insecurity using Addcomm as no message was given if the program verified successfully, leaving the user wondering if any checking had been done at all.

Repair a bad program: Surely there can be no user of the BBC Micro who hasn't cursed at the inevitable "Bad program" error message following loading, altering, OLDing or rerunning a Basic or machine code program.

Certainly the writers of these toolkits must have suffered this problem frequently, as a utility to repair a bad program was included on all the chips tested.

All worked adequately though it was difficult to test every possible program corruption against each chip.

Move a program: The ability to move the whole of a Basic program to a new position in memory and reset PAGE is available on five of the toolkits.

This facility is most useful when a program requiring lots of memory has been loaded from disc or telesoft and needs to be downloaded to &E00 in order to run.

All the five toolkits were able to move a Basic program up or down in memory, reset PAGE and facilitate a run without further modifications.

Toolstar's *MCOPY was the most difficult to use as it required knowledge of the program's start and end addresses in hexadecimal.

The *BSHIFT command of ToolkitD was the most flexible as whole Basic programs or specified chunks of

A little bit of magic from MERLIN COMPUTER PRODUCTS

AN UNBEATABLE COMBINATION! A WORD PROCESSOR
AND DATABASE WHICH CAN BE INTEGRATED.

MERLIN SCRIBE

The first professional
word processor
for the BBC
disc system.

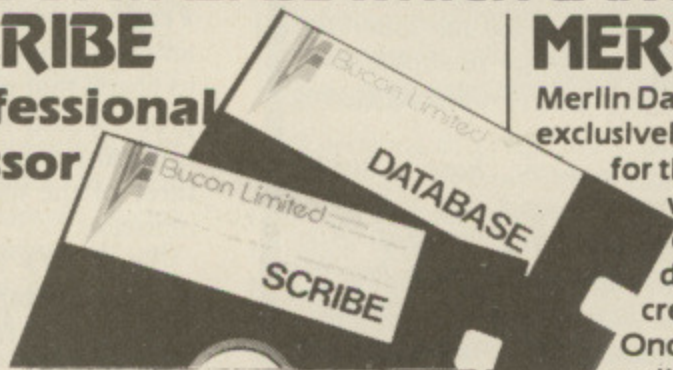

Scribe is a screen-oriented, integrated word processing system specifically designed for non-technical personnel. Text and command functions are fully prompted.

The program comes in a chip with five minute fitting instructions, a 5 1/4" floppy disc containing the printer driver and a comprehensive instruction manual.

Among the many features available are:

- Create up to 255 pages in a single document.
- Screen user selectable 40 or 80 column with choice of background and text colours.
- Insert text at any page on the document whether currently in memory or not.
- Powerful editing commands:
Move, copy and delete with affected text displayed in reverse video. Will move or copy within a page or to any other page in the document.
- Word search and replace — item by item or globally throughout the document.
- "Go to page" — next and previous using up and down cursor keys or go directly to page numbers
- On screen underlining.
- Format line controls document width and allows setting of right and left margins.
- Tabs set on format line as required.
- Automatic centre and decimal tab.
- Text reformatting.
- Split page and dynamic page break display.
- Word count and display of cursor position by column & line number.
- Will use disc surfaces 0 to 3 as allowed by the BBC system.
- All disc filing operations menu driven, eg. re-name, copy, delete document, compact and catalogue disc, etc. No knowledge of the disc system required.
- Exec document — allows conversion of BASIC programs for editing by word processor and then re-conversion back to either text or program files.
- File merge — one or more documents or other text files may be merged in sequence from any disc drive between 0 and 3.
- Automatic page numbering with page number insertion at any point on the page.
- Headers and footers.
- Total facility print module including selection of serial or parallel output, global printer control codes, page numbering offset, print from page to page, repeat print, etc.
- Selection of up to nine user definable keys for insertion of printer control codes into text, with up to five codes allocated to each key.
- Control number of page display lines for scroll speed increase.

The program comes attractively packaged in a simulated leather grain wallet which contains the manual, disc, chip & function key legend strip.

MERLIN DATABASE

COMING SOON

Merlin Database is a database system designed exclusively for the BBC disc based computer. It provides for the structural input of text and numerical data which is stored permanently as a record on the computer. A group of records constitutes a database. Any number of databases may be created using Merlin Database.

Once created there are sophisticated facilities available for searching, selecting and drawing off information from the database by means of defining the search characteristics. This information can then be formatted for producing printed reports, lists etc.

Performance

- Maximum records per database 4000
- Maximum record size 1800 characters
- Maximum no. of fields 32
- Maximum no. of characters for any single field 900
- Find any record in 2 seconds via key field access
- Search every character in a 100 kb database in 29 secs

Field Types

- Numeric — up to 9 digits
- Date
- Sub fields for economic disc usage i.e. specify average & maximum field size

Data Search

- Search results directory held with database on disc
- Data can be passed to mail merge and report writer
- 16 level conditional search
- Search conditions include 'not', '>', '<', '='.
- Wild card
- Database automatically sorted by key field
- Database can be set to re-sort to any alternative set of key fields

Report Writing

- Database will integrate with Merlin Scribe word processor
- Format printer output with simple forms editor
- High powered forms layout & editing using Scribe (alls. rt. justify)
- Arithmetic calculations & accumulators
- Conditional report writing
- Semi programming facility for forms & report generation

Other Facilities

- Mail merge using Scribe
- Conditional mail merge
- Automatic reformatting of lines
- Capable of conditional transfer of information between databases.

Database comes in chip with manual, simple fitting instructions & systems disc. Also planned is the production of Database integrated with the Merlin Scribe word processor in a single chip although the database is designed to integrate easily with Scribe in a separate chip.

MERLIN DATABASE £49.00
MERLIN SCRIBE £59.95
MERLIN SCRIBE/DATABASE £95.00

Prices include VAT. Price and specification subject to change without prior notice.

Credit card orders accepted. Special discounts for educational establishments and dealers.

MERLIN COMPUTER PRODUCTS (BUCON LTD)
35/36 SINGLETON STREET, SWANSEA SA1 3QN
Tel: (0792) 467980 (3 lines)



Now you need not pay through the nose for a good face!

TAXAN

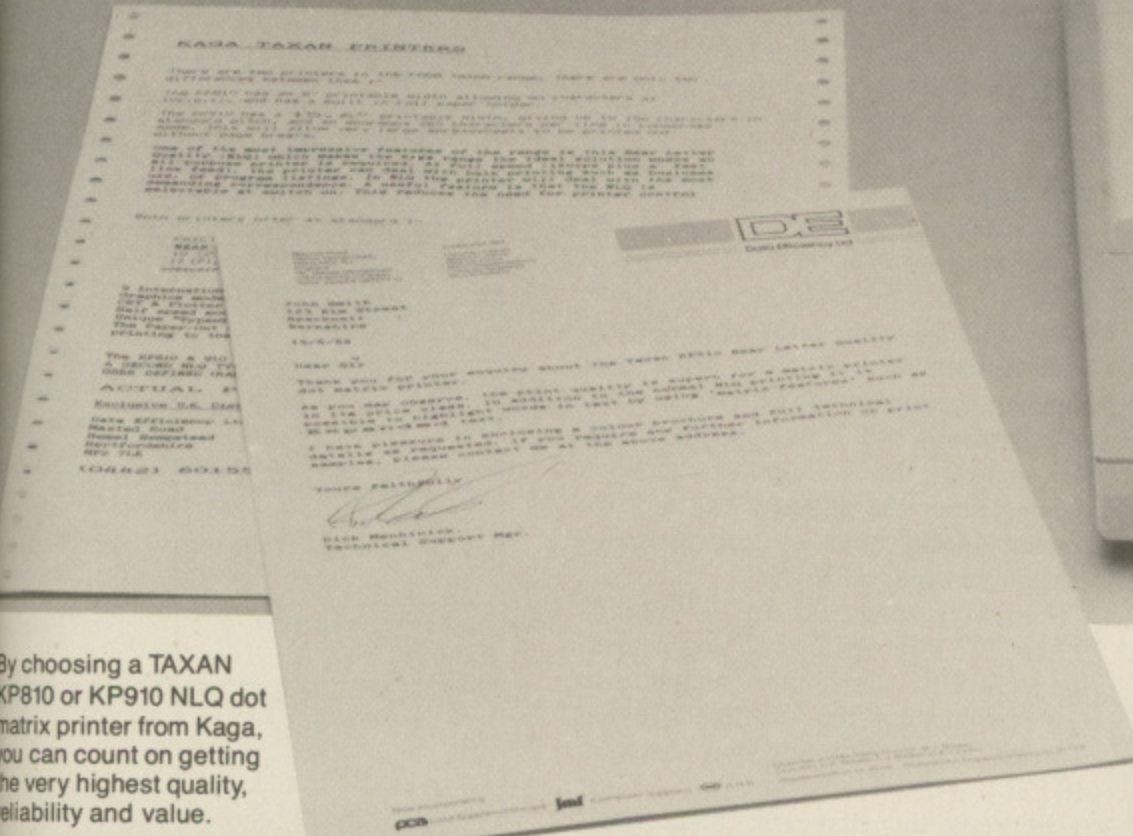

By choosing a TAXAN KP810 or KP910 NLQ dot matrix printer from Kaga, you can count on getting the very highest quality, reliability and value.

PRINT QUALITY

Both printers offer all the standard features found in dot matrix graphics printers. But really excel when it comes to Near Letter Quality (NLQ) printing, producing output that equals or exceeds the quality of printers costing considerably more.

FEATURES

The KP810 and KP910 share some very impressive features: ■ 160 cps print performance. ■ NLQ double pass printing – selectable at switch on. ■ Unique incremental printing mode. ■ Friction feed and tractor feed. ■ Standard Centronics interface (serial option available). ■ Fully compatible with all popular

software packages, including Lotus 1-2-3, Applewriter, Wordwise etc. The KP810 has a built in roll paper holder. The KP910 will accept extra wide paper (up to 17") – printing 156 char/line normal print.

VALUE

With all these features you might expect to pay more. But at around £299 for the KP810 and £399 for the KP910, these printers give excellent value for money.

All prices ex-VAT and correct at time of going to press.

TRADE AND OEM ENQUIRIES WELCOME.

AVAILABLE FROM W. H. SMITH AND OTHER PROFESSIONAL DEALERS NATIONWIDE.

EXCLUSIVE UK DISTRIBUTOR. TAXAN IS THE NEW BRAND NAME FOR PRODUCTS MANUFACTURED BY KAGA ELECTRONICS CO. LTD.



Data Efficiency Ltd

Whatever your system... insist on KAGA TAXAN

Computer Peripherals Division, Maxted Road, Hemel Hempstead, Herts. HP2 7LE Tel: (0442) 60155 (20 lines) Telex: 825554 DATEFF G



64K RAM buffer, expandable to 256K, capable of controlling two separate printers at one time... and more.

RING 0442 60155 FOR DETAILS

Firmware Review

From Page 57

machine code could be moved around in memory.

Merge programs: Finally, in the main list of facilities compared, is an alternative to BBC Basic's *SPOOL command for putting program parts together.

In practice this facility is mostly used to append already saved procedures to a

Molitoool (Molimerx)

Compared to the others this chip seems rather expensive in view of its sparse command set and the poor implementation of some of them.

Even so it is almost worth having just for the brilliant, though not perfect, variable dump and cross referencer. Certainly the other toolkit writers should take good note of the standard to attain in this area.

*Molitoool also offers a useful screen display of all the current character definitions (*CHAR), another facility that could become standard on toolkits.*

Molitoool's manual was the only one deviating from the now usual A5 format. There is also room for improvement in the clarity of the documentation.

program in memory. This feature was poorly implemented on Aids II and was for appending one program already in memory to another.

On ToolkitB *MERGE did the job adequately and informed the user when similarly numbered lines had been overwritten. The same command on Caretaker and ToolkitD was even more unfriendly as these ROMs did the overwriting or even subsequent renumbering without telling the user.

The latter two, however, did have the added bonus of being able to insert

Toolkit (Dataware)

A novel, but eventually annoying, feature of this chip is its security aspect. From switch on, between the beep and the bop sound Toolkit asks for a password. If you get it wrong after three tries the owner's name and address appears on the screen, the keyboard is locked and an alarm sounds. (Fortunately you can buy this chip without the security feature.)

After getting through this I found Dataware offered a rather unusual

appended programs from a file into the main program even if line numbers were similar. The new program could then be renumbered.

Conclusions

A variety of useful and often well thought out facilities are available on the seven ROMs tested.

Overall, the range and implementation of commands on Beebugsoft's Toolkit and Computer Concept's Caretaker probably makes them the best of the bunch.

These chips seem to provide no incompatibility problems when used alongside various other ROMs, including the Watford DFS.

Their use of prefixes - B for Beebugsoft, C for Computer Concepts and also T for Molitoool - help to discourage command clashes, but it may have been even safer to provide a function to shut off unwanted ROMs from the toolkit.

Further improvement, particularly in the areas of a full HELP (error checking) facility, a complete cross referencer, and full variable and array dumps is desirable.

None of the chips offer much information on the status of peripheral devices such as disc drives, printers or speech processors, nor on visualisation of extraneous end of line spaces. I look forward very much to updated versions which rectify the deficiencies, improve implementation and also provide complete tube compatibility.

Finally, what about a decent TRACE/STEP facility to supplement the awful BBC version, bringing it up to the standard of the Commodore Pet Toolkit which had this way back in 1979?

Perhaps the first 16k Basic (plus machine code?) programmer's toolkit for the BBC may achieve all this first time around!

choice of commands for a Basic programming aid. Not present were function key editing, variable dumps, cross referencer and clever renumbering, but included were keyboard lockouts, CRC checks and an archival disc to tape and vice versa loader.

One facility implemented on this chip which every other should have had was the proper error reporting aid which marks the character(s) at fault. In addition the documentation was quite good.

ROM	Toolkit	Ad
Version	1.21	
Code length	8k	
Supplier	Beebugsoft	Vin
Cost	£27	
Signature presence	-	
Memory used	-	256
Documentation	32 pages	72
Prefix	B	
Commands	27	21
Memory usage	*FREE *H.INFO ++++	M
Function keys editor	-	F
Renumber lines	*RENUM +++	
Move lines	*UTIL3 ++	
Find	*UTIL1 r ++++	FIND ++
Replace	*UTIL2 r ++(+)	GREP SREP ++
Cross reference	*UTIL4 +	
Variable dump	*UTIL5,6 ++(+)	LVAR +
Shorten	*PACK S ++	OMPA ILLRE ++
Lengthen/ clear read	- -	- LIST r ++(+)
Verify program	*CHECK ++	ERIFY +++
Repair program	*RECOV +++	OODP +++
Move program	*MOVE +++	
Merge programs	*MERGE ++	
Other commands	*MEMOR *CLEAR *EDIT *NEW *OLD *ON/OFF *REPORT *ONF *SCREEN	DCOM AR WIN/V OTO FOR/C T GO c raphic

Toolkit	Addcomm	Caretaker	Toolstar	Aids II	Molitoool	Toolkit D
1.21 8k Beebugso £27 - 32 pages B 27	1.00 8k Vine Micros £28 - 256 bytes 72 pages - 21 (40)	1.00 8k Computer Concepts £33.35 yes - 30 pages C 18	1.77 6.5k Pace £34 yes - 127 pages - 12 (23)	2.10 8k Softsmith £25 - - 24 pages - 11	0.21 8k Molimerx £33.35 - - 9 pages T 11	1.02 8k Dataware £22 yes - 30 pages - 20
*FREE *H.INFO ++++	MEM +	*STATUS +++	-	-	-	*BMEM +++
-	FKEYS +	*KEYSAVE *KEYLOAD +	*FKEYn ++	-	*FNKEY ++	-
*RENUMB +++ *UTIL3 ++	- -	*RENUMBER ++++	*OPEN + -	*LREN +++ *LMOVE +++	- -	*BMOVE ++
*UTIL1 ran ++++ *UTIL2 ran ++(+)	FIND range ++++ GREPL range SREPL range ++++	*EXCHANGE +++(+)	*FIND +++ *REPLACE ++	*AIDS S +++	*FIND ++ *CHANGE range +	*BFIND range ++(+) *BSR range +(+)
*UTIL4 + *UTIL5,6,7 ++(+)	- LVAR range +	*LVAR P + *LVAR F.I.S.A ++(+)	- -	*AIDS V ++(+)	*VLIST range +++(+) *VAL %, \$, () +++(+)	- -
*PACK S,R ++	COMPACT range KILLREM range ++	*SQUASH S,R,M +++	-	-	*STRIP R.S. ++	*BPACK 1,2,3 ++
- -	LLIST range +(+)	*EXPAND range +++	*FLIST +	*AIDS L *LLIST +++(+)	*PAD - +	- *BLIST range *BLIM +++
*CHECK ++	VERIFY +++	-	-	-	-	*BVERIFY +
*RECOVER +++	GOODPROG +++	*RETRIEVE +++	*FIX +++	(*AIDS S) +++	*MEND *MEND+ +++	*BMEND +++
*MOVE +++	-	*MOVE +++	*MCOPI ++	-	*MOVE +++	*BSHIFT ++++
*MERGE ++	-	*MERGE *INSERT ++(+)	-	*LMERGE +	-	*BMERGE *BOVERLAY ++(+)
*MEMORY *CLEAR *EDIT *NEW *OLD *ON/OFF *REPORT *ONF *SCREEN	DCOMM AR TWIN/WIN OTO PFOR/GOS/REP RT OGO commands graphic commands	*CURSOR *PARTSAVE *TABSTOPS *NO TAB *SINGLEKEY *NORMALKEY	*CONV *RESET *MDUMP *MROM *MCRC *EXTEND 4 disc commands 6 machine code commands	*AIDS D *AIDS M *AIDS B *AIDS P	*CHARS	*ARCHIVE *RETRIEVE *BCRC *BEQUIV *LOCK *UNLOCK *BREPORT *BROFF

A 'B' or 'D' suffix has been added to Toolkit throughout the text and in the table to distinguish the two chips. Facilities are scored as + (poor), ++ (satisfactory), +++ (good) or ++++ (very good). () indicate half marks. - indicates not available.

KAY-ESS

COMPUTER PRODUCTS

PROFESSIONAL PROGRAMS FOR THE MODEL B AND ELECTRON

EACH TAPE ONLY £5.95 (Except H.O.H.)

HOUSE OF HORRORS (B)(E) £6.95

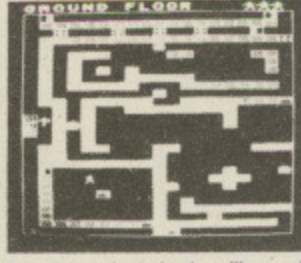
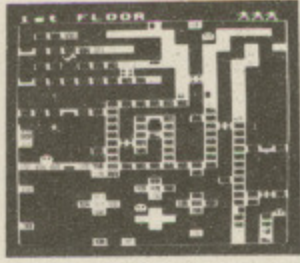
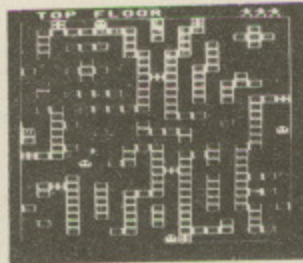
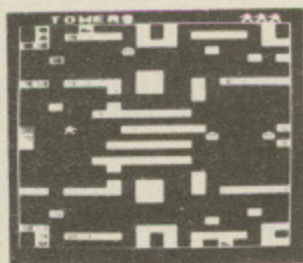

Turn off the lights and gather around for the most creepy game of the year. How you laughed at those superstitious fools in the village when they warned you not to go near the old house. The climb up the rocky path under the afternoon sun was swift and within an hour you had passed through the outer gates of this once great house. The dust and cobwebs hadn't bothered you as you climbed the old stairs to the towers on the top level. Did you notice how low the sun had fallen before the sounds of locks clicking reached your startled ears? How can the moon be out already and what's that moving towards you??? This all action game will have you ducking and diving from the GHOSTS and ZOMBIES, and matching wits with a MUMMY, WEREWOLF, and VAMPIRE. 5 floors full of odd CORRIDORS, BROKEN FLOORBOARDS, and riddled with SECRET PASSAGES await you. Superb sound effects and graphics. Can be played using either keyboard or joysticks. Top table. Pause option.

EARLY YEARS (B)(E) For children between 3-6 years of age. These two packages give an adult or older child a means to take a younger child through a series of simple game type tasks to enforce ideas. The emphasis is on learning through fun. Topics covered include subtraction, addition, recognition, colour, shapes, sizes, sounds/notes, co-ordination, distances, estimates, directions.

EARLY YEARS 1

- A) MICKEY THE MONKEY and his apple tree make subtraction fun.
- B) COLOUR BLOCKS bring sizes and colour into perspective.
- C) MERRY MUSIC turns the keyboard into a musical keyboard.
- D) FUNNY FACES presents a line up, which one is the suspect?
- E) FRED THE FROG needs co-ordinated help to get across the pond.

EARLY YEARS 2

- A) THE POND seems very active today
- B) SPEED is required to keep the cake on the conveyor belt.
- C) DIRECTIONS seem to be needed by everyone in Orion village.
- D) ORDER the blocks.
- E) SID THE SPIDER needs some help to get out of the maze.

Watch out for HOUSE OF HORRORS at local dealers. Dealer enquiries welcome.

All prices are FULLY inclusive for UK orders. Please add £1 per tape for non-UK addresses. Cheques/P.O.'s should be made payable to KAY-ESS Computer Products.

When ordering please state BBC or Electron.



Joystick Compatible

Available for:
(E) Electron (B) BBC Model B
FREE with all orders (Except H.O.H.)
our 3 level version of
NOUGHTS AND CROSSES!!!

ALSO AVAILABLE:

- STAR HAWKS (B) (E) - DESIGN (B) (E)
- HANGMAN (B) (E) - SPACE TRAFFIC CONTROLLER (B) (E) - HORSES (B) (E)
- SPACE TANK (B)

KAY-ESS Computer Products,
11 Buttercup Close,
Romleighs Park,
Harold Wood,
Essex RM3 0XF.

99% OF ALL BBC SOFTWARE CAN NOW BE PLAYED ON JOYSTICK

Wizard Development have brought out two simple-to-use accessories for your BBC Micro that will enable you to not only make the most of your machine's capabilities, but enjoy for the first time full joystick control over almost the entire range of BBC Software.

£17.50
Plus P&P*

JOY ROM

Converts keyboard only games to full joystick control, can be used with any existing BBC joysticks. No software required, simply insert the JOY ROM

£14.95
Plus P&P*

JOYSTICK INTERFACE

Now use any Atari type joysticks on your machine (two joystick sockets) Also available Quickshot II joystick at only £9.95 plus P&P*



SPECIAL MAIL ORDER OFFER. THE ROM AND INTERFACE FOR CHEQUES MADE PAYABLE TO WIZARD DEVELOPMENT.

£29.95
Plus P&P*

*Post & packaging 60p single items, £1.00 special offer.

AVAILABLE FROM ALL GOOD COMPUTER DEALERS OR DIRECT AT OFFER PRICE FROM WIZARD DEVELOPMENT, 22 CARVER STREET, SHEFFIELD S1 4F. Dealer and distributor enquiries welcome. Telephone (0742) 752732

Half a box is better than one?

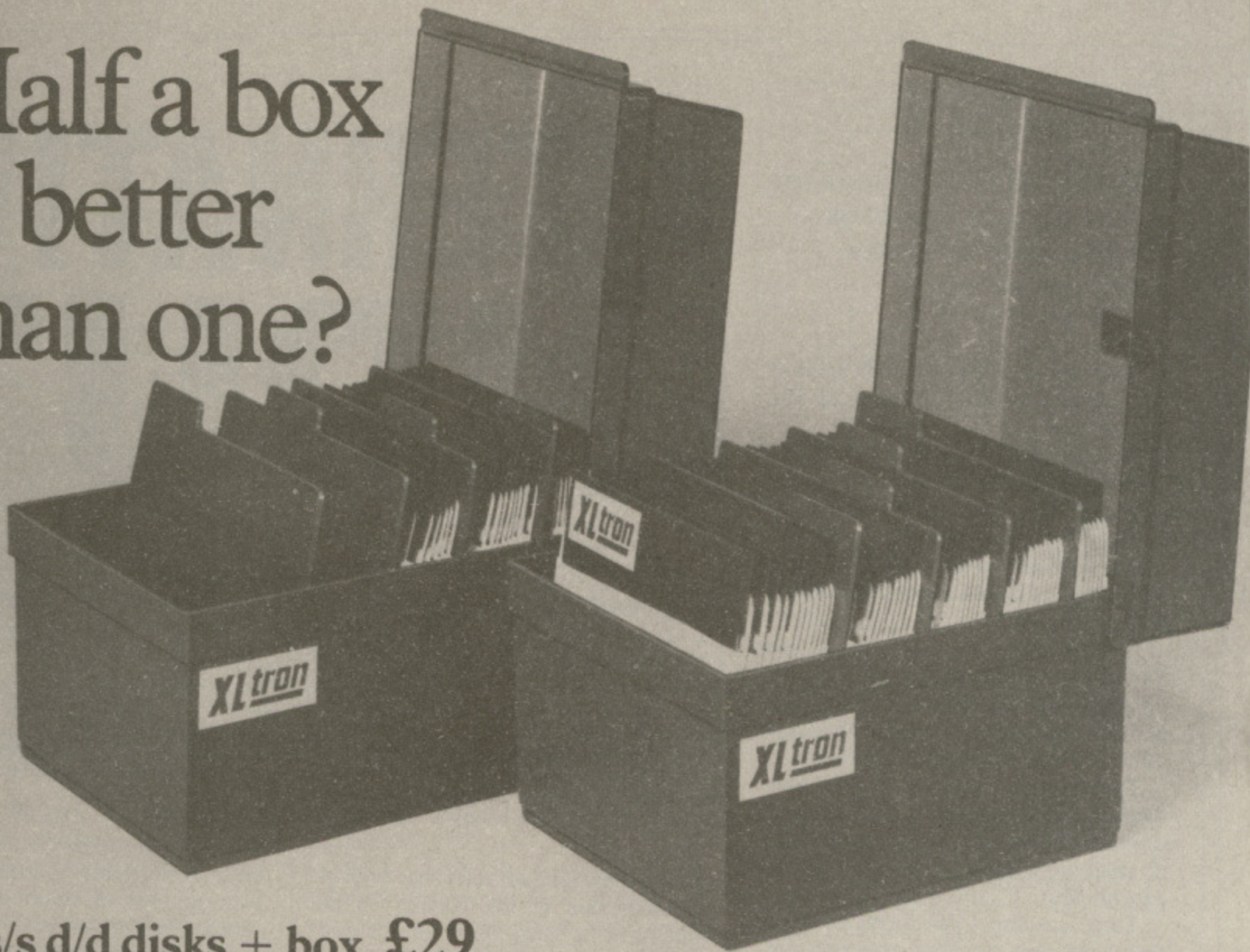

25 s/s d/d disks + box £29
plus VAT and P + P

25 d/s d/d disks + box £39
plus VAT and P + P

50 s/s d/d disks + box £50
plus VAT and P + P

50 d/s d/d disks + box £75
plus VAT and P + P

We ran the advertisement opposite to move some stock left from a cancelled order. And move them it certainly did. We're still selling around 30 boxes a day, that's over 30,000 disks a month. So we bought some more, and are going to continue selling at the same price.

We also got a lot of people on the phone asking if we could supply slightly fewer disks, and as you see, we're now offering boxes in 25's as well.

Every order of 25 or 50 comes packed in the same rigid plastic storage box with four dividers, we've kept the same high specification and all disks carry our two for one guarantee.

To order, just clip the coupon below. Personal callers welcome.

We accept orders from all government bodies, schools, universities, libraries, armed forces etc. We despatch on receipt of an official purchase order. If you can't raise a cheque without an invoice please post or telephone your order and we'll send you a proforma by return.

Disco Technology Limited, Lex House, 3/6 Alfred Place, London WC1, England. Telephone 01-631 0255,

Please rush me

- ___ (qty) storage box(es) filled with 50 s/sided disks at £59.50 each.
- ___ (qty) storage box(es) filled with 50 d/sided disks at £87.25 each.
- ___ (qty) storage box(es) filled with 25 s/sided disks at £33.65 each.
- ___ (qty) storage box(es) filled with 25 d/sided disks at £47.15 each.
- ___ (qty) empty storage box(es) at £11.

Prices include VAT and P + P. I enclose cheque for _____

or debit my Access card no. _____

Name _____ Signature _____

Address _____

Postcode _____ Telephone _____

To: Disco Technology Ltd, Lex House, 3/6 Alfred Place, London WC1.

Take Advantage of us!

50 s/s d/d disks + box - £50 plus VAT + p&p
50 d/s d/d disks + box - £75 plus VAT + p&p

Discount with disks and accessories, we'll sell them to practically anyone, anywhere. So when we get a telephone order for a lot of storage boxes and disks we don't waste any time and stock up. Then the order was cancelled. So we're having to let them go at cost, in fact, less than cost.

For just £59 we can supply a rigid, high impact plastic storage box, with four dividers packed with 50 single-sided, double-density disks. The same storage box filled with 50 double-sided, double density disks will cost just £75. And all carrying our five year guarantee - if a disk is faulty send it back for free replacement.

To order just clip the coupon below

To Disco Technology Ltd,
3/6 Alfred Place,
London WC1E 7ED

Please rush me _____ (qty) storage boxes filled with 50 single-sided _____ (E2 already added for p&p and insurance) I enclose a cheque for £ _____

Name _____ Address _____ Telephone _____

Signature _____

To Disco Technology Ltd,
3/6 Alfred Place,
London WC1E 7ED

DISCO-TEK

© Certain Advertising Ltd 01-930 1612



MU-10

ROBIN NIXON discusses ways to help disabled people communicate with the micro

MANY readers will be typing in some of the listings printed in this issue of *The Micro User*.

Disregarding typing mistakes, this is the simplest, quickest and most effective means of accessing a micro we have yet invented.

The keyboard is so standard to most people that if it were not there it would be sorely missed.

It may seem that I am stating the obvious, but there is a group of people for whom the keyboard is and will be – perhaps forever – a closed door. I am talking about the severely disabled.

There are alternative inputs now available that can be used by some disabled people, notably the mouse that is used to control Apple's Lisa and Macintosh.

There are also some forms of input that have been designed especially for the disabled which, due to their simplicity, can also be useful to able bodied people.

In attempting to overcome the communication difficulties of disabled people – many of whom are severely speech impaired – it is necessary to start by going back to the micro's natural language, binary.

Having only two states (on or off), it is ideal for someone who may have control over only one muscle and therefore can only use one switch.

There is really only one workable system for a one switch user, and that is a scanning matrix display as shown in Figure I.

On pressing and holding down one switch a cursor scans across the display at a pre-selected rate. Each column in turn will be highlighted. When the column containing the desired character is reached the switch is released.

Pressing the switch a second time and

A	B	C	D	E	F	G
H	I	J	K	L	M	N
O	P	Q	R	S	T	U
V	W	X	Y	Z	£	sp
0	1	2	3	4	,	del
5	6	7	8	9	.	ret

Sp : Space del : Delete ret : Return

Figure 1: Alphanumeric scanning matrix display

ALTERNATIVE INPUT

Switch 1	Switch 2	Binary	Decimal
OFF	OFF	00	0
OFF	ON	01	1
ON	OFF	10	2
ON	ON	11	3

Figure II: The four possible states available from two switches.

again holding it down will cause each of the characters in the column to be highlighted in turn. When the chosen character is reached the switch is released and the character entered into memory.

As might be expected, with each extra switch added more bits of information can be input. Using two switches you get four bits to play with. (See Figure II.)

However you normally only have two bits, rather than four, as the "all off" state, where neither switch is pressed, cannot easily be used and many two switch users can only press one switch at a time.

With many severely disabled people two is the maximum number of switches that can be used. With two switches scanning the matrix becomes easier.

The first can be used to scan across, the second to scan down and the first, pressed a second time, to "enter" the chosen character. Listing I is just such a program.

This program can be used to replace most inputs. However, in cases where other characters than those in the matrix are required, you could use the £ sign as a toggle switch between this matrix and one of your own choice.

For example, replace lines 100 and 260 and add lines 350 and 360 as shown in Listing II.

The program will now alternate between an upper and lower case matrix each time £ is selected.

Using alternative displays is a useful feature for disabled people as it means

they do not have to scan through a huge number of characters of a full comprehensive matrix.

Selecting @ is the equivalent of pressing Return.

There are many small adaptations that can be made to some programs that are useful to both keyboard and switch users.

For example, many programs offer the user a menu of some sort. Using a procedure such as the one described above you could replace the Input command.

But a simpler means of selection between items in a menu is to highlight

```

10 T$="":#FX11,50
20 #FX12,50
30 MODE7:PRINTT$:PROCINPUT(0,
TO30
100 DEFPROCINPUT(PX,QX):PROCSC3
":VDU31,PX,QX
110 PROCSC3:IF B%=13 THENPRINT
ROC
120 IFB%=127ANDT$<>" THENT$=LE
$,LEN(T$)-1):PRINTB$;:GOTO110:EL
Z=127THEN110
130 T$=T$+B$:PRINTB$;:GOTO110
140 DEFPROCSC1:FORVX=14TO24STE
U31,10,VX,131:NEXT:FORXX=0TO6:F
=0TO2:VDU31,11+XX*2,14+YY*2,XX
7*YY:NEXTYY,XX:VDU31,11,20
150 PRINT"V W X Y Z £ ";CHR$25
31,11,22:PRINT"0 1 2 3 4 , [":VD

```

Listing I

PROCEDURES

- PROCINPUT** Called with two parameters which tell the procedure where to print the line to be input – as with PRINT TAB(X,Y).
- PROCSC1** Displays the matrix on the screen.
- PROCSC2** Used when scanning to place alpha blue characters in front of the characters being scanned, and alpha green after them – to keep the rest of the display the same colour.
- PROCSC3** Calls PROCADV L to determine which of the two buttons is pressed (if any) and then either calls PROCSC2 to show the current column or character being scanned, or returns to PROCINPUT with a selected character.
- PROCADV L** Waits until a switch is pressed and returns with AD% equal to either one or two. For people who do not have access to paddle or joystick inputs, PROCADV L will accept the keys "Z" and "X" as switches one and two. Although the BBC Micro is capable of interfacing in many ways, we chose the ADVAL (Analogue to Digital VALue) port as this seems the simplest to use. As in Figure II, ADVAL(0) AND 3 will return a value between 0 and 3.

*							*
*							*
*			*				*
*	*	*	*	*	*	*	*
*	*	*	*	*	*	*	*
*			*				
*			*				
*							

Carriage return

	*	*					
*			*				
*	*	*	*				
*			*				*
*			*	*		*	*
			*		*		*
			*				*
			*				*

Alternative menu

Figure III: Control symbols for a scanning matrix display

each of them in turn. This could be accessed by two switches – one to scan and one to select – or by the arrow keys and Return.

This also avoids the need to check whether or not an input is valid.

Programs that require the user to input the same word many times, such as adventure games, could include the most commonly used words – if not all – on the screen so that they can be quickly selected by scanning.

Mode 7 is the simplest mode to use for scanning because it is only necessary to insert one control character before the character or line to be highlighted, and sometimes a highlight cancel character afterwards. However the

graphics modes can offer more flexibility.

Modes 2 and 5, having only 20 columns of text, are more suitable for people with visual impairment. In all Modes except Mode 7, user defined characters can be displayed.

This would enable us to replace the @ and £ signs for chosen carriage return and alternative menu symbols.

See Figure III.

Drawing is something you may consider inaccessible to a two switch user, but this is not the case.

Using Logo or another Turtle based language, it is possible to move forwards, left, right, pick the pen up and put it down with only one keystroke,

providing the angle of turn and distance have been pre-set.

In fact, with a little ingenuity, nearly all programs could allow for two switch input. Programs that have been written with an alternative input in mind are always easier to use for everyone.

I would be pleased to hear from anyone interested in writing or adapting programs for alternative input or from any disabled people who would like the catalogue of our program library.

The address to write to is: *Robin Nixon, Advisor on Computer Aids for the Disabled, COMPAID, Seven Springs Cheshire Home, Pembury Road, Tunbridge Wells, Kent TN2 4NB.*

```

124:PRINT"5 6 7 8 9 . @";:ENDPROC
160 DEFPROCSC2:NNX=&7BBB+40*16+DPX*
FORFFX=F61XTOF62XSTEP2:?(40*FFX+NNX
)=CCX:?(40*FFX+NNX+1)=131:NEXT:ENDP
OC
170 DEFPROCSC3
180 F61X=0:F62X=10:DPX=0
190 CCX=132:PROCSC2:PROCADV L:IFADX=
GOTO220
200 CCX=131:PROCSC2:DPX=DPX+1:IFDPX
7:DPX=0
210 GOTO190
220 CCX=131:PROCSC2:VDPX=0
230 CCX=132:F61X=VDPX:F62X=VDPX:PRO
SC2:PROCADV L:IFADX=1 GOTO260
240 CCX=131:PROCSC2:VDPX=VDPX+2:IFV
DPX=12 PROCADV L:VDPX=0:IFADX=1 GOTO18
250 GOTO230
260 BX=? (NNX+40*VDPX):IFBX=ASC"[" B
X=127 ELSE IFBX=ASC"@" BX=13 ELSE IFB
X=255 BX=32 ELSE IF BX=35 BX=96
270 B$=CHR$BX:CCX=131:PROCSC2:ENDPR
OC
280 DEFPROCADV L:QTZ=0:*FX15,1
290 ADX=ADV AL(0)AND3:IKX=INKEY(0):I
F(ADX=0 OR ADX=3) AND IKX=-1 PNTX=0:G
OTO290
300 IFPNTX=0 PNTX=1:GOTO330
310 Z1X=0:REPEATZ1X=Z1X+1:IF(ADV AL(
0)AND3)=0 PNTX=0:Z1X=200:QTZ=1
320 UNTILZ1X=200:IFQTZ=1 GOTO290
330 IFIKX=90 ADX=1 ELSE IF IKX=88 A
DX=2 ELSE IFIKX<>-1 GOTO290
340 ENDPROC

```

```

100 DEFPROCINPUT(PX,QX):TGLX=0:PROC
SC1:T$="":VDU31,PX,QX
260 BX=? (NNX+40*VDPX):IFBX=ASC"[" B
X=127 ELSE IFBX=ASC"@" BX=13 ELSE IFB
X=255 BX=32 ELSE IF BX=35 TGLX=TGLX+1
:IFTGLX=1 PROCALTERNATIVE_MATRIX:VDU3
1,PX,QX:PRINTT$:;B%=0 ELSE IFBX=35 TG
LX=0:PROCSC1:VDU31,PX,QX:PRINTT$:;B%=
0
350 DEFPROCALTERNATIVE_MATRIX:FORVZ
=14TO24STEP2:VDU31,10,VZ,131:NEXT:FOR
XXZ=0TO6:FORYYZ=0TO2:VDU31,11+XXZ*2,1
4+YYZ*2,XXZ+97+7*YYZ:NEXTYYZ,XXZ
360 VDU31,11,20:PRINT"v w x y z £ "
;CHR$255:VDU31,11,22:PRINT"! "" # $ %
;[" :VDU31,11,24:PRINT"& ' ( ) ? : @
";:ENDPROC

```

Listing II

Challenging games

**Brainteasers for the BBC and
Electron Computers**

By Genevieve Ludinski
(Phoenix Publishing Associates)

spark off ideas



THE subtitle of Brainteasers for the BBC and Electron Computers is Programs to Puzzle and Amuse, and this just about sums it up.

This book is a collection of 29 puzzling listings, each one an interesting and amusing challenge.

I must admit it made a nice change to come across a collection of games that didn't rely too heavily on my reflexes. There were no hordes of alien nasties whizzing across the screen. Just gentle, intriguing challenges.

The programs cover mazes and safe cracking to mathematical sequences and pattern sorting. I particularly liked the idea of Close Encounters of the Fourth Kind, an intergalactic game of Simon.

With 29 listings to choose from there must be something to satisfy every taste. Most of these listings aren't long, which encourages you to type them in.

At first sight they looked jumbled and

cluttered but I had little difficulty entering them.

Well, no more than usual. And the games were well worth the effort of typing them in.

A nice feature is that each listing has a few paragraphs of program hints. These greatly add to the book's value.

They give explanations of techniques used in the programs and hints on how to make them easier or more difficult. I'd love to know who wants them to be harder!

Another aspect of the book is that it acts as a stimulant for your own ideas. I've never written a brainteaser game

but the book sparked off lots of ideas, and it also showed me ways of writing them.

There's only one thing that I'd complain about. One of the programs I ran gave me an IQ rating. It must be wrong, I'm far more intelligent than that!

Despite that, it's an enjoyable book, far from the usual run of the mill set of games listings. If you like puzzles and you've got a BBC Micro then you'll like this book.

Trevor Roberts

The basics of Basic made friendly

I MUST admit when I first saw the Friendly Computer Book and read the blurb on the back, I reacted unfavourably.

I was convinced it would be one of those computer books which confuses being simple with being simplistic, and explaining in easily understood terms with talking down to people. The fact that it had cartoons in it didn't help my prejudices, either.

Happily, though, when I actually got down to reading the book as opposed to reacting to it I got a very pleasant surprise. I found that it really was the friendly and simple introduction to Basic programming.

The book starts with a general introduction to the world of computing and explains some of the jargon. Nowhere does it go into things too deeply.

But what it has to say is thorough and makes sense. It gives the answers to the sort of questions that beginners have but feel might be too daft to ask.

The Friendly Computer Book

By Jonathan Inglis (BBC Publications)

It then goes on to cover keyboard skills and in the third chapter starts on programming. The remaining ten chapters deal with Basic programming in simple, clear terms.

New concepts are introduced gradually and logically and thoroughly explored in some delightful little programs.

The novice is painlessly lead through the early keywords (LIST, RUN and so on) through loops, decision making, arrays and simple data handling, onto simple sound, graphics and animation.

The presentation of the book is excellent. The listings are clear, and the cartoons amusing and helpful.

The "Chip's Workshop" at the end of each chapter adds a nice, friendly and educational touch to the main text. Each chapter also carries a summary of what

it contains.

The only reservation that I have about the book is that as it's written to cover three micros (the BBC Micro, the RML380Z, and the Spectrum) the programs don't make much use of the more advanced structures of BBC Basic.

Still, in what is meant to be a very elementary beginners book, I can't see that that's any real fault. In fact considering it covers three micros, each with different commands, the book is amazingly easy to follow, a tribute to whoever designed it.

So, all in all, an excellent little book that I would recommend to those who find the more traditional type of textbook too daunting.

It may be a little too simple for some tastes but it's certainly one to bear in mind when buying beginners books.

It is a very friendly guide to the basics of Basic and a gentle introduction to micros for the young.

Trevor Roberts

You'd have to spend over £3000 to beat our £199 Second Processor.

The BBC Micro is already one of the fastest and most powerful micros around.

But with the addition of the 6502 Second Processor, it becomes the fastest micro in its price range.

(To be fair to the opposition, their £3000+ package includes a disc drive. But a similar BBC Micro set-up with the 6502 Second Processor will cost you less than a third!)

The 6502 greatly expands the Micro's usable memory. Its 64K of RAM combines with the BBC Micro's 32K, for a total of 96K.

It is supplied with its own special version of BBC BASIC, called Hi-BASIC, which allows the maximum amount of this memory to be used for BASIC programs and variables. Other languages allow some or all of this memory to be used for programs, and many will automatically adjust themselves to make maximum use of available space.

What's more, the 6502 uses the same microprocessor as the BBC Micro, but at a much higher speed. Which means programs can run up to 50% faster.

The 6502's extra power enables it to run more powerful software, such as that provided with the Acorn Bitstick, which turns the BBC Micro into a versatile computer graphics station. In fact, it has a variety of features usually found only on much larger systems.

It can also exploit the full potential of local area networking through the Econet system, with Level 2-File Serving.

So to get the most from your BBC Micro, get the 6502 Second Processor.

The 6502 Second Processor is available from your BBC stockist. For the address of

your nearest supplier, ring 01-200 0200.

If you wish to order by credit card, phone 0993 79300 during office hours.



6502 Development Programs (available seperately)

MASM: A 6502 macro-assembler. A full range of macro facilities are provided, including looping recursive calls and conditional assembly.

XREF: A cross-referencer to be used in conjunction with MASM.

ViewEdit: A full screen editor based on the VIEW word processor.

TRACE: A 6502 trace package for de-bugging all types of program.

PRINT: A program to produce formatted assembly listings without using MASM.

The package is provided with a 250-page manual describing all the facilities provided by the system.

Technical Specifications

The Second Processor operates at a clock rate of 3MHz. A version 1.2 MOS will need to be fitted into the BBC Micro before operating the 6502.

Integral power supply

Measurements: 205mm x 345mm

Weight: 2.1 kg

Colour: BBC Computer cream

Construction: Moulded top and bottom to match BBC Computer profile. ABS injection moulded plastic.

Power in: 240v, 50Hz, 3w.

The BBC Microcomputer System.

Designed, produced and distributed by Acorn Computers Limited.

Available at selected Boots,
Laskys, Spectrum (UK) and other leading
computer outlets.



**MAKE THE BBC
AN EXPERT AT
COMMUNICATIONS.**



The BBC Micro is unbeatable when it comes to holding your attention. But when it comes to talking to the rest of the outside world it's virtually speechless.

Until, that is, you speak to us.

In which case you and your BBC could soon be accessing viewdata systems throughout the country.

By simply linking your BBC into our purpose-designed communications and viewdata system you dramatically increase the capability of your micro. Allowing you to keep in touch with your friends. And to get answers within minutes to electronically mailed letters. You can even try your hand at the latest adventure games on Micronet 800 (as well as looking at the news, reviews, prices and best-buy information).

In addition to all this, you will also be able to access Prestel. A vast database of news and information. Helping you to book tickets for your favourite concerts. Plan your road and rail trips. And even check the weather forecast before you go.

Our communications and viewdata systems open up the world to you and your micro. And at a down-to-earth price - with systems starting from under £90.

So, if you're keen to contact the outside world... simply contact us.

APPROVED for use with telecommunication systems run by British Telecommunications in accordance with the conditions in the instructions for use.

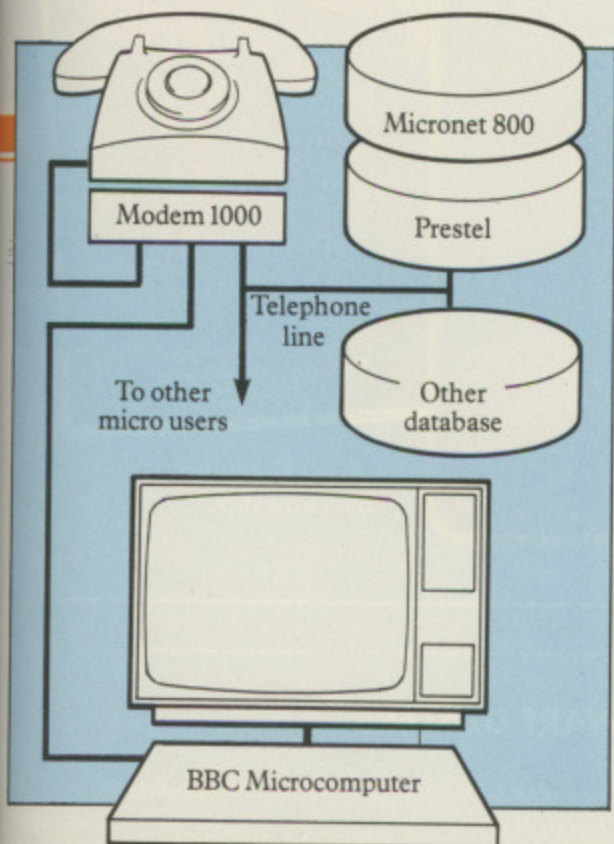

Prism Business Systems Ltd.
Prism House, 18-29 Mora Street
City Road, London EC1V 8BT
Tel: 01-253 2277



Please send me further details of the Prism communications and viewdata system for the BBC Micro.

Name _____

Address _____

Tel: _____

BMU10



TEACH YOUR COMPUTER SOME NEW TRICKS

Transform your computer into a letter writer, a chess master, a design aid – with these high-quality programs from BBC Publications.

Word Mover

An easy-to-use text editor offering many of the facilities of a word processor – but none of the complications. It gives you a wide choice of display, editing and printing options.

£9.95 Cassette/booklet

For Model B or Electron

Game Core

This intriguing package shows you how to write your own computer board games. It includes three ready-made games, and a fourth one that is explained in detail as a tutorial model.

£10.95 Cassette/booklet

Astronomy

Vivid graphical demonstrations which bring astronomical subjects to life. The programs include phases of the moon, solar eclipses, planetary motion – even the chance to pilot your own spacecraft!

£13.80 Disc/booklet

£9.20 Cassette/booklet

Drawstick

This friendly program can produce elaborate high resolution pictures and patterns in four colours. It enables children to create pictures, charts, maps and diagrams, and can be used as a Computer Aided Design tool. It includes a fast 'save' routine.

£9.95 Cassette/booklet

White Knight Mark 11

This powerful chess program is now available for the Electron. It outclasses and outplays several well-known chess programs, and compels even experienced players to treat it with respect!

Cassette/booklet

Model B version £11.50

Electron version £9.95

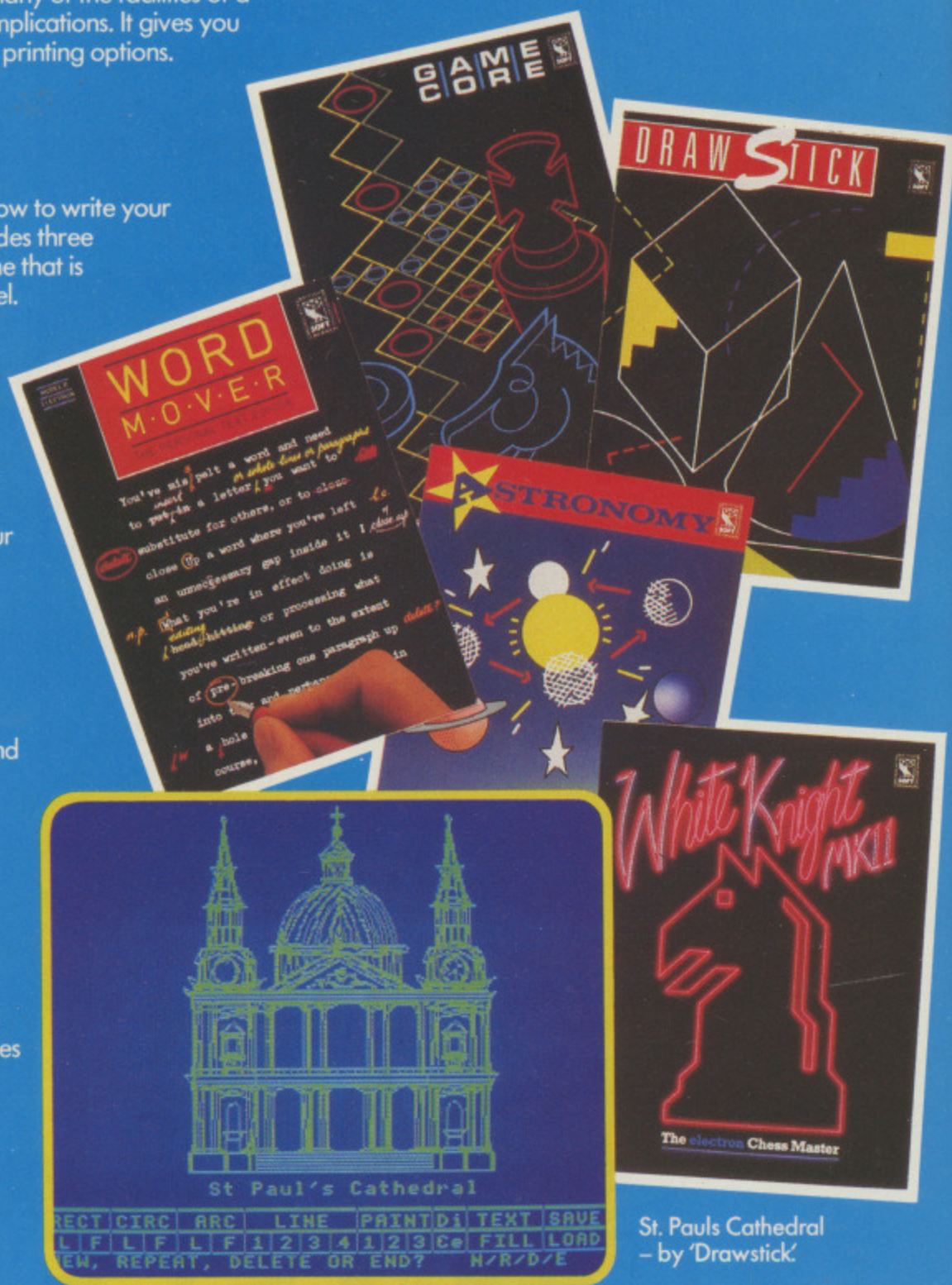

St. Pauls Cathedral – by 'Drawstick'



Word Mover will run on your Electron. An Electron version of White Knight is now available

FROM BOOKSELLERS AND SOFTWARE DEALERS

All software is for the British Broadcasting Corporation Model B Microcomputer except where indicated. Every pack includes full documentation. Prices include VAT.

I RE
Micro
At th
told t
pack
track
drives
tracks
softwa
I w
how
softwa
Micro
discs.
It s
who
drives
out as
don't
discs.
My
obviov
anyth
ROMs
When
it is us
(Z80)
Wh
issued
PAGE
of the
DFS n
This
that th
the de
why w
machin
Z80 in
the 650
Also
worksp
of the 6
Z80 ha
St Hel
● You
and 80
commar
able on
DFS R
The c
and yo
tracks b
It is no
the Aca
The

MIKE COOK'S PROBLEM PAGE



From 40 to 80 tracks – using software commands

I RECENTLY bought a BBC Micro and a Torch disc pack. At the time of purchase I was told that the drives in the disc pack could read both 40 and 80 track discs just like switchable drives, only the number of tracks could be changed by software instead of switches.

I would dearly love to know how to do this as almost all software available for the BBC Micro is supplied on 40 track discs.

It seems to me that people who have bought 80 track drives have in some way lost out as software producers just don't want to know 80 track discs.

My second problem may seem obvious to those who know anything about sideways ROMs, but it has me baffled. When the computer is turned on it is using the second processor (Z80) and running CP/N.

When the Basic command is issued and Break is pressed, PAGE drops to &2800 instead of the more usual &1900 as on DFS machines.

This could be due to the fact that there is a CP/N ROM in the default ROM socket, but why would a ROM with a machine code written for the Z80 in it need workspace when the 6502 is running?

Also, if it does need some workspace, why not use some of the 64k of memory which the Z80 has with it? – R.C. Swain, St Helens.

● You can switch between 40 and 80 tracks with a software command, but this is only available on certain non-standard DFS ROMs.

The one I use is by Watford and you can change to 40 tracks by typing *FX110,0,255. It is not possible to do this on the Acorn DFS.

The CP/N ROM contains

code written in 6502 machine code to enable the BBC to be used as a CP/N input/output device. It doesn't contain Z80 machine code – that is stored on a ROM on the second processor board itself.

Upon power up, the operating system asks each ROM if it wants to reserve any space. The CP/N ROM says "Yes please" as it does not know you don't want to use it.

Try making this ROM not the default ROM and then reset the value of PAGE.

Invasion hold up

I HAVE keyed in Alien Invasion by Tom Blackburn from the February issue of *The Micro User*, but have run into a problem which I hope you can help me with. Needless to say I have checked and double checked the input but can not find any error.

When the program is run I get ERROR LINE 20 – HIMEM NOT SPECIFIED. To remedy this I inserted a value for HIMEM=31744 at line 6.

This has allowed the program to be run to some extent until the base is hit. Then the score and high score numbers change to undecypherable cyan sym-

bols and the high score words change colour to cyan too.

This in turn causes another error in the Hall of Fame, where the score is not recognised by the computer. – S. Ebrahimi.

● Take your computer immediately to the dealer as this error message indicates it is about to explode!

PS: Acorn have never heard of this one either.

'twas not to be . . .

BEING an avid reader of *The Micro User* and wanting a ready made map of Europe, last January's issue was a godsend.

The mere triviality that my computer was a 32k Model B, Basic I, OS1.2 seemed (at the time) unimportant.

I realise the program was written for the Electron, but as there were no indirect imperatives involved I wasn't too worried as I thought at least the plotted data would be useful.

Alas poor Brian, 'twas not to be (I never did trust those DIM(1%) anyway).

If I promise never to use Electron software (even typed) on my Beeb could you let me have some idea of how to

amend the listing.

Looking forward to a decent night's sleep. – B. Tomlinson, Sutton-in-Ash, Notts.

● I am stuck here. The program works OK on my machine, although I have to confess that I did not type it in but used that issue's tape. Can any reader help?

Joystick warning

I RECENTLY bought a £20 set of joysticks with the intention of using them with a BBC Micro. Unfortunately they turned out to be little more than a few on/off switches operated by a stick and were totally unsuitable for my purposes.

I have always been under the impression that a joystick is an analogue device and not, as these were, digital. On this basis I returned to the shop and requested a refund which was flatly refused.

I then wrote to the shop to request a refund, and received no reply. I telephoned, getting another refusal but an offer of a credit note enabling me to buy something that I didn't want.

I feel it would be wise to warn other micro users not to make the same mistakes. Before buying any accessory check that:

● The dealer offers a reasonable service and has a fair policy on the return of goods.

● The accessory is clearly

You've got a problem with your micro and you just can't sort it out on your own? Then write to MIKE COOK. If he can't help then probably no one can . . .

From Page 71

described on the packaging or receipt and that the description suits the purchaser's requirements.

● If there is any doubt, insist on a demonstration before parting with your money. — *S.W. Maxwell, Southsea, Hampshire.*

● A joystick can be either analogue or digital — this was explained in my article in the May 1983 issue of *The Micro User*. Therefore you have not been misled by the company, and they were perfectly right to sell you what they did.

To make sure you get the analogue type of joystick you must specify that it is a proportional joystick you want.

Still waiting . . .

IN the first edition of *BBC Micro User* dated March 1983 there appears on Page 50 an article headed Beeb Body Building Course.

In it there is a "... sneak preview of what is coming up" including "a way of connecting a TV video camera to your BBC computer".

I have bought every issue of *The Micro User*, but have been unable to find any trace of this item in subsequent issues.

Could you please tell me in which issue the item appeared, or, if it is still awaiting publication, in which issue it is scheduled to appear? — *Nic Small, Brighton.*

● It is something I want to do, honest. It is just that I have not had the time so far to tackle the project.

I'll try to fit it in as soon as I can.

Think it into submission!

I HAVE a BBC Model B with OS1.2, Watford DFS (fitted by myself) and 100k Pace disc drive.

There's a small problem with the disc drive which Watford and Pace have not been able to help me with, but on taking the

drive to my local dealer it works perfectly.

Although the drive operates and has been doing so for six months, on putting the disc in the slot the motor starts to run but the indicator light remains out, and it only stops running when the lever is down.

Open the lever and the motor remains off until the disc is removed, when the motor starts again, runs for a few seconds and then turns off on its own.

Can you solve this problem as I fear it may eventually damage my discs. — *D. Ryder, St Helens.*

● This is the well known case of "it works when a dealer is looking at it but not when I do it". You have to be positive and think the drive into submission, let it know who is the boss, and then it will start to behave.

Alternatively you could check that all the leads are correctly seated at both ends of the disc cable and that none of the chips in the disc drive interface have a leg bent underneath them.

Using the Atom RAM

I RECALL reading somewhere that no significant benefit could be gained from linking the BBC Micro to an Atom.

This is a great shame, since the humble Atom is not the easiest creature to dispose of. On the other hand, it does have certain features which I am sure could be of some use to the BBC Micro user.

The most obvious of these is

I HAVE attempted to build for my son the graphics digitiser as detailed by you in the June 1983 issue of *Micro User*.

I am unable to calibrate it as described and I wonder if you could suggest what may be wrong.

I have checked the wiring thoroughly and can assure you it is correct.

It was suggested by one of the representatives on the Technical Advice stand at the recent Electron & BBC Micro User

IF you have a technical query for this page, send it to Mike Cook, *The Micro User*, Europa House, 68 Chester Road, Hazel Grove, Stockport SK7 5NY.

Letters on other subjects should be sent, as usual, to Micromail, which this month starts on Page 177.

the 12k of RAM. With this in mind I wonder if it would be possible to use the Atom as an extended printer buffer?

I have no technical knowledge whatsoever, which is probably why the idea sounds so promising. Perhaps you would like to give it some thought. — *Nick Kiey, Plaistow, London.*

● Thanks for the suggestion, it would be a good idea to use an Atom in this way.

Unfortunately I have not right now got the time to do this, but would consider printing an article from anyone who has!

A TV into a monitor

I HAVE a Grundig B3404 TV and I wonder if any reader knows how to convert this to a monitor/TV, or indeed of any dealer who would carry out this conversion.

I have been taking *The Micro User* since I bought my BBC Micro and I think it is the best magazine on the market. Keep up the good work. — *T. Franklin, Northampton.*

● Without knowing all about the inside of this type of TV let me say what you will be required to do.

First of all you need to fit an isolating transformer to the set. Then you need to tap into the video driver circuits with the RGB signals.

As the resolution of the tubes used for a TV set are generally

lower than that used on monitors the result will be of inferior quality and I do not think it is worth the expense.

Try Irvine Developments on 0294 72431. They carry out this type of work on ex-rental TVs.

Changing mode

IN reply to Mr Layton's letter about how to change mode in a procedure, you use VDU 22,2 to change to Mode 2. The number after the comma is the mode number.

Please could you tell me which pins to use on my user port to use a home made light pen that fits into the analogue port on the BBC Micro?

Lastly, can you tell me where to get an SD 4324-002 Sweet-spot light detector for the light pen which is featured in the Beeb Body Building Course Part 6? — *Ian K. Levy, aged 11, Leeds.*

● Yes, this will work, but use it with caution as some of your variables can be overwritten. It is usual to come down in modes, that is change from Mode 2 to Mode 7, but not the other way round.

A light pen cannot be fitted into the user port as there is no connection to the CRT controller chip from that socket.

You can get the Sweetspot from the *Micro User*, along with all the other bits — or see my Problem Page in the July 1984 issue.

Pots of problems...

Show that I may have logarithmic pots.

This I have checked with the supplier, who assures me that they are wirewound linear pots and the correct value.

The pots have a travel of approximately 270 degrees. At one extreme I am able to calibrate below 1023 but I hit zero after travelling back approximately 150 degrees. I have identical results on both pot A and pot B.

I realise it is difficult to give

advice without seeing what I have done, but perhaps it is obvious to you from my description what is wrong. — *H. Martin, Edinburgh.*

● The problem might be insufficient adjustment on the preset pots Ps1 to Ps4. To remedy this you could insert a series resistor with one or more of these pots.

Try using a 10k one, as this will give you adjustment that starts where it previously left off.

The Aries File

CRUSHED BETWEEN AN IRRESISTIBLE FORCE AND AN IMMOVABLE OBJECT?

If your high-resolution screen is squeezing you from one side, and your operating system from the other, isn't it time you tried the ARIES solution? ARIES-B20 is the board which banishes forever the conflict between screen graphics and program memory. "bad mode" and "No room" become nightmares of the past when your Beeb possesses this unique expansion.

Unlike "sideways-RAM" systems, ARIES-B20 offers you *transparent* access to 20K of extra memory, replacing the RAM swallowed up by the high-resolution graphics modes. The extra RAM is switched in completely automatically, meaning that your existing software can make use of it *without modification*.

This means that if you're a programmer, you have up to 28K RAM available for BASIC, FORTH, LISP, BCPL, LOGO and COMAL programs in *ANY SCREEN MODE*. If you're a business user, the extra memory is used by

VIEW, VIEWSHEET, WORDWISE and many other applications. And if you're a scientific type, you can get access to a massive 47K of data storage using the Acorn-approved ARIES ★FX call.

COMPATIBILITY ASSURED

With the huge range of Beeb add-ons that are becoming available, compatibility has become a real headache. Every extra you buy your computer might lock you out from a host of others, even if it works with those you already possess.

ARIES-B20, designed by BBC Micro experts, offers you true upgradeability. In addition to the rest of the ARIES family (the ARIES-B12 ROM expansion board and the ARIES-B488 IEEE-488 interface unit), ARIES-B20 is compatible with double-density disc controllers, second processors, ECONET, hard discs, EPROM programmers and

much more. Several major companies now test all their products with ARIES-B20 to ensure compatibility.

PROFESSIONAL QUALITY

The ARIES range is designed to work with *all* BBC Micros, not just some of them. This means it has a sensible regard for the capacity of the power supply and the natural variations in critical timings between machines. All new ARIES products are subjected to brutal testing in extreme conditions before they are released on the market.

In quality of construction, the ARIES range sets a standard against which others are judged. Custom-made connectors eliminate the damage to the BBC machine caused by inferior products. Units are electronically tested before, during and after manufacture. And all this is backed up by the ARIES 1 year no quibble guarantee.

WHAT THE PRESS SAID

"the most exciting add-on"
- Times Educational Supplement, March 1984

"a very professional product"
- A & B Computing, March/April 1984

"an attractive solution to the lack of sufficient memory on the Beeb"
- Beebug, March 1984

"this is an impressive piece of equipment in its own right and deserves to be taken seriously"
- Acorn User, April 1984

"the trouble with a paged RAM system is that the software has to be aware that it is there. The Aries RAM board gets round this limitation brilliantly"
- The Micro User, June 1984

NOW AVAILABLE THROUGH DEALERS

To cope with the continuing growth of demand, the unique ARIES-B20 RAM expansion has now been made available through selected dealers. Although ARIES-B20 can be fitted by a complete layman in a matter of minutes, a fitting service is offered by approved dealers to those customers unwilling to delve inside the case of their BBC Micro.

The recommended retail price of ARIES-B20 is just £115 (inc VAT) for the B20 board, operating system extension ROM and detailed manual. Enquire at your local dealer or order direct by post from the Manufacturers (see below).

(Machine requirements: Model 'B', MOS 1.2. Hardware plugs into CPU socket, software uses one sideways ROM socket)

How to order:

Send cheque or postal order made payable to:
Aries Computers
and forward to:

Aries Computers
Science Park, Milton Road,
Cambridge CB4 4BH
Telephone Cambridge (0223) 862614

Please send me (Qty.) ARIES-B20(s) at £79.95
(incl. P.P. & VAT)

I enclose a cheque/postal order made payable to

Aries Computers for £.

Signed

Name (block letters)

Address

Post Code

SYSTEM SOFTWARE

•ROMs FOR THE BBC MICROCOMPUTER•

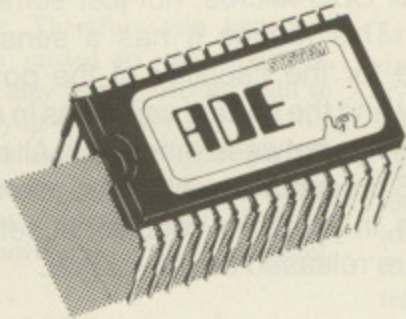

The complete program development package for assembly language programmers. ADE is the de facto industry standard for professional software writers using the BBC microcomputer. The 16k ROM contains a full 6502 MACRO assembler; a dynamic text editor; a front panel debugging monitor and disassembler. ADE comes complete with a 160 page comprehensive reference manual and a utility/macro library disc. ADE can also be used with tape based machines.

The ASSEMBLER features macros with library facilities; nestable conditional assembly; flexible listing options (with or without macro expansion); hex, decimal, binary and ASCII data formats; dummy section; full range of arithmetic and logical operators; symbol table sort and dump; file chaining and 29 powerful pseudo ops. Source and object files are kept on disc so there is no limit on program size or location.

The EDITOR is designed with the programmer in mind for writing both programs and documentation. The editor includes a very powerful command language (including macros) that enables much editing to be done on a semi-automatic basis. It features full screen editing and deferred edit modes; no limit to document size; edit with backup facilities and a versatile text formatter.

The DEBUGGER is instantly accessible for inspecting, modifying and disassembling machine code programs. Features include full 64 byte display in hex, ASCII and disassembled format; registers; stack; single step; breakpoints; memory search and much more.

Price £60 inc vat. Please specify 40 or 80T utility disc.

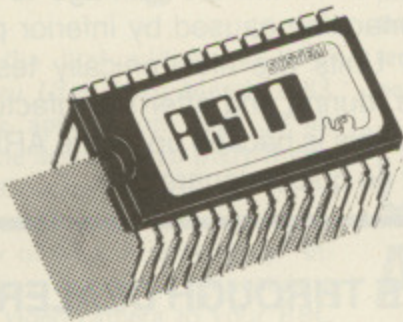

ASM provides all the superb features of the ADE macro assembler on its own ROM.

The program source file may be written using any editor (even Wordwise or View!). Complete with reference manual and utility/macro library disc. Use the assembler that professional software writers use.

Price £35 inc vat. Please specify 40 or 80T utility disc.

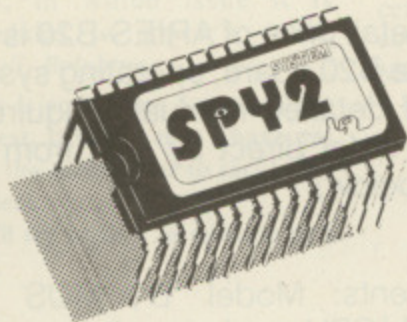

SPY2 is a front panel debugging monitor, disassembler and disc utility ROM. SPY2 is instantly accessible to the programmer for inspecting, modifying, debugging and disassembling machine code programs. SPY2 also features a relocater and program trace facilities. SPY2 will access any ROM either in the sideways ROM sockets or on an extension board. ROM memory may be displayed, single-stepped through or disassembled.

SPY2 includes a set of powerful disc recovery commands for interrogating, editing and retrieving data stored on a floppy disc. SPY2 also includes a disc formatter as well as a non-destructive single track reformatter.

In all SPY2 has a comprehensive set of 23 utility commands. These are supported by an excellent Reference Manual.

The SPY2 front panel encompasses all the superb, easy-to-use facilities of the renowned SPY debugging monitor PLUS additional commands for toggling and finding breakpoints; relocating machine code programs; single stepping through subroutines in one go and facilities for accessing the front panel from programs in RAM or ROM with breakpoints, OSBYTE or CTR-F.

SPY2 features a versatile disassembler with hex dump, full and intelligent disassembly. This identifies data areas in the program; these being displayed as a hex/ASCII dump. Operating system calls are labelled creating very readable code. The powerful trace facilities enable program instructions and register contents to be traced to printer whilst the program is running. Indispensable for graphics programs as they can be stepped through whilst observing the effects on the screen.

SPY2 features a disc sector editor displaying the contents of a whole sector; disc search facilities for finding byte patterns or strings and free disc space. Files may be recovered by creating a directory entry with all the data concerning the deleted file. Directory entries can be easily amended using the *AMEND command. The *FORMAT command formats discs with any number of tracks. A verify command checks discs. The *REFORMAT command is extremely useful for recovering information from a bad track, reformatting it and restoring the data. Commands are included for loading files at 81900 and automatically downloading (and running) them.

The most comprehensive of all debugging/disc utility ROMs.

Price £30 inc vat.

SYSTEM

Dept. B 12 Collegiate Crescent, Sheffield S10 2BA



HOW
enviro
now a
write e
But yo
progra
out ag
How
acquir
"page
add ex
RAM
cheap
This
easily
which
that is
dozen
use a
routin
Side
memo
just b
that
&BFF
adres
Th
micro
some
the n
data t
is usu
that
adre
to the
Thi
of the
may l
Un
RAM
neces
given
WI
opera
turn,
the m
in fro
of the
page
It
sidew
is itse
hand
short
easy
Th
whet
more
recog
begin
absen

GOING ON THE

RAM PAGE

By **TONY PHILLIP**

HOW many BBC owners have gazed enviously at those clever ROM chips now available and wished they could write even a little one for themselves? But you need an epromer to put your program in and a UV eraser to take it out again when it doesn't work.

However many people have now acquired sideways (the technical term is "paged") ROM boards with spaces to add extra RAM chips. Also dedicated RAM boards are available quite cheaply.

This makes it possible to write and easily correct ROM type software which runs in this upper RAM area. All that is necessary is to get the first two dozen bytes set up correctly and then to use a few fairly short machine code routines.

Sideways ROM lives in the area of memory from just above the screen to just below the operating system chip, that is from addresses &8000 to &BFFF, thus occupying a maximum address space of 16k.

The read/write line from the microprocessor is connected through some circuitry to the sideways ROM. In the normal BBC Micro writing some data to a ROM will have no effect, so it is usual to wire up the sideways RAM so that any write operation within addresses &8000 to &BFFF is directed to the sideways RAM.

This is all taken care of in the design of the particular ROM/RAM board you may have.

Unless you have multiple sideways RAMs no special programming is necessary - just follow the programs given.

When searching for a ROM the operating system switches each on in turn, starting from number 15. This is the most easterly of the four sockets just in front of the keyboard. It keeps track of the current ROM number in a zero page location &F4.

It is impossible to directly access a sideways ROM from Basic, since Basic is itself a sideways ROM. However by handing control over from Basic to a short machine code program it is quite easy to call up other ROMs.

The operating system works out whether there is a ROM in any one or more of the 16 possible ROM spaces by recognising a specific few bytes near the beginning of the ROM. If these are absent then the operating system will

ignore that ROM number.

The operating system may need to enter a ROM for two different reasons. The first is the service entry where a service is requested by ROM A and is provided by ROM B, which then passes control back to ROM A.

An example of this occurs when a Basic program asks a disc filing system to CHAIN a program held on disc.

Control is handed over to the DFS, which loads the program and then hands control back to Basic in order to run it.

The second reason is the language entry where the selected ROM is entered and control is taken over by a language in that ROM. One way out of a language is by a hard break (Ctrl+Break) which should return control to Basic. For convenience the soft break has been designed to return control back to the selected language.

When the operating system comes across a command it does not recognise

the ROMs are scanned and given the opportunity to react to the unrecognised command.

The programs given in this article add the new commands *RAM and *RAML. These make a service and a language entry respectively into the ROM.

Once within the ROM a routine has been provided to demonstrate the service entry.

The listings are written in Basic and by now it should be reasonably obvious that we cannot access another ROM from Basic.

So when the assembler is used it assembles the correct codes, but when it tries to print them out, it reads them from the Basic ROM, not the sideways RAM you have written to - so your listing will look rather odd.

The correct bytes - shown in Table I - are as follows:

&8000-8002: Holds the location for a

The first few bytes of the ROM must be set up like this:

Address	Hex	Instructions	Note
&8000		.ram	
&8000	4C 7D 80	JMP langentry	1
&8003	4C 25 80	JMP serviceentry	2
&8006	82	EQUB &82	3
&8007	11	EQUB &11	4
&8008	01	EQUB &01	5
&8009		.title	
&8009	52 41 4D	EQUB "RAM"	6
&800C	20	EQUB &20	
&800D	31 2E 30 30	EQUB "1.00"	
&8011	00	EQUB &00	7
&8012	28 43 29 31	EQUB "(C) 1984 G.A. PHILIP"	
	39 38 34 20		
	47 2E 41 2E		
	50 48 49 4C		
	49 50		
&8024	00	EQUB &00	
&8025		.serviceentry	8

Table I: An example ROM/RAM configuration

From Page 75

language entry into the ROM. Control will pass from the old language via a JMP xxxx to the new language.

&8003-8005: Holds the location for a service entry. All ROMs must have a service entry (only the Basic ROM does not have one). The address from which the service has been called is stored on the stack, so that by executing a RTS, control is easily returned.

&8006: This identifies the ROM type. In binary, &82 is 10000010. Bit 7 indicates that the ROM has a service entry. This must be set. If bit 6 is set, this indicates that the ROM has a language entry and may be considered for selection on a hard reset. In this example, the bit is left unset and so, while the ROM can still have a language entry, this has to be explicitly started up (for example *RAML) and will only be reselected on a soft break. Bit 1 must be set.

Note that EQU B is a Basic II command which places a single byte

into the memory pointed to by P%. In Basic I the equivalent is:

```
] : ?P%=&82:P%=P%+1:[
```

EQU B places a string - its equivalent is:

```
] : $P%="xxxx";P%=P%+LEN($P%)+1:[
```

Both of which are followed by the appropriate OPT.

&8007: Copyright offset pointer. By adding the number here to &8000 we get the location of the first byte of the copyright message for example at &8011.

&8008: The binary version number. This is of no relevance to the system. A user may like to know that this is Version 1.

&8009-8010: The title message - in this case RAM 1.00 will be printed up on a *HELP. It is also used here as a convenient way of providing a command name.

&8011-8024: The copyright message. This, like the title message, can be of any length since its start has been pointed to by the copyright pointer. The crucial four bytes are the "(C)" (&00 &28 &43

&29) which identify the ROM to the system. The message itself must be preceded and terminated by a zero.

&8025: Free for user machine code programs.

The two most common reasons for the operating system to make a service entry are firstly when an unrecognised * command is detected (for example *RAM) and secondly in response to the *HELP command which asks each ROM to identify itself, usually by displaying its name on the screen.

We must first provide a way of selecting between these alternatives and, if neither apply, control should be returned with all registers preserved.

On a service entry, the operating system marks the place where it has come from (by saving this address on the stack), turns on the first ROM and jumps to the address given in the service entry.

The accumulator contains 4 if there has been an unrecognised command or 9 if *HELP has been used. Other service

A Hardware Guide For The BBC Microcomputer.

A 260 A4 PAGE BOOK WHICH INCLUDES:-

- ★ Comprehensive circuit description.
- ★ Full step-by-step details on upgrading Model 'A' to Model 'B'.
- ★ Full details on fitting disc and speech expansions.
- ★ Full explanation of all link settings and functions.
- ★ Full of circuits, hints, tips and modifications (many previously unpublished).
- ★ Full manufacturers data sheets on all major IC's including:-
R6522, 8271, 6502, MC6845, MC6850, SN6489AN, UPD7002, SAA5050, HM4816, 2764, 27128, 7400 series pin-outs.

ALL DEALER ENQUIRIES WELCOME

A MUST FOR BOTH ENTHUSIAST AND ADVANCED USER ALIKE

To order send cheque/PO for £11.95 plus £1.50 p&p (UK only)
(Overseas readers - printed paper rate surface mail - £3.00 p&p - air mail extra).

ORDER FORM

Please send copies of "A Hardware Guide for The BBC Microcomputer"

At £11.95 each plus £1.50 p&p (UK). I enclose cheque/postal order for £.....

NAME

ADDRESS

All orders and enquiries to

WISE-OWL,

Hull Innovation Centre, Guildhall Road, Queens Gardens, Hull HU1 1HJ.

A Com
packed

Now the
is suitabl
thermal p

Quality

The Eps
print qual
The P-40
means it c
three kind
(condense

Light, Q

Since the
no ink rib
portable b
into the p
and easy

Top Qua

The quali
is unequa
A superic
dots toget
letters ens
The comp
printing w

Self Test

The P-40
useful self

Please rush

and

Name

Address

Introducing The New Epson Micro Printer At Only £99.95 inc. VAT

Ideal for use with the BBC Micro, and most popular home computers.
Parallel and RS232 versions available.

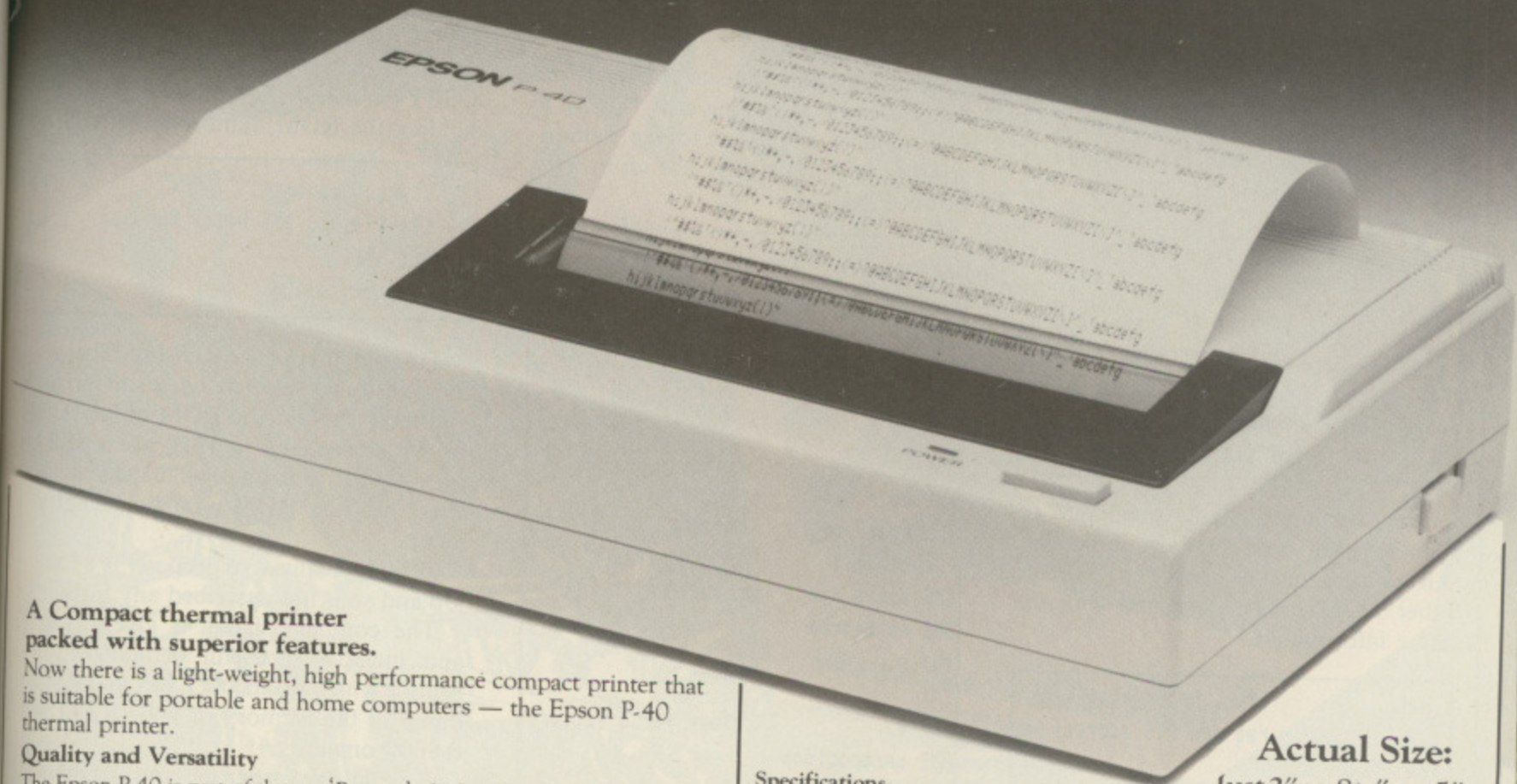

A Compact thermal printer packed with superior features.

Now there is a light-weight, high performance compact printer that is suitable for portable and home computers — the Epson P-40 thermal printer.

Quality and Versatility

The Epson P-40 is part of the new 'P range,' which offers a micro printer with print quality identical to that found in the Epson range of superior printers. The P-40 is the first low cost printer that can print 480 dots per line which means it can reproduce graphs, and pictures beautifully. The P-40 can offer three kinds of column capacities: 20 columns, 40 columns and 80 columns (condensed) — no other compact printer offers such a selection.

Light, Quiet and Cost Efficient.

Since the P-40 is a thermal printer, operation is particularly quiet and there's no ink ribbon to change. Maintenance is simple. In addition the P-40 portable battery-driven printer has four rechargeable NiCad batteries built into the printer which can be recharged in 6 hours. It's simple, economic and easy to use.

Top Quality Image and High Speed Printing.

The quality of printing in all Epson printers is unequalled and the P-40 is no exception. A superior Epson head design featuring nine dots together with it's ability to express small letters ensures superior legibility. The compact P-40 also provides high speed printing with 45cps.

Self Test Function

The P-40 compact thermal printer has a useful self test function.

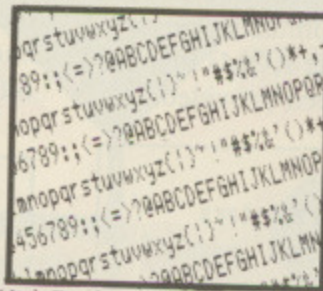

High Resolution Print - Actual Size

Actual Size:

Just 2"(H) x 8 1/2"(W) x 5"(D)

Specifications

Print Method	Thermal Dot Matrix
Print Speed	45 Characters per second (For 40 and 80 column setting)
Print Direction	Unidirectional (Left to Right)
Character Set	96 ASCII character, (Featuring English Capital Letters, English Lower Case Letters, figures, signs and graphics)
Character Size (mm)	2.4 (H) x 1.7 (W) Normal 2.4 (H) x .85 (W) Condensed 2.4 (H) x 3.4 (W) Enlarged
Paper	Epson Thermal roll paper P-40 TRP
Paper Feed	Friction Feed
Paper Width	112mm
Power Supply	NiCad Batteries, Internal

**WATCH OUT FOR
THE NEW EPSON P-80
COMING SOON**

**(0442)
60155**

ORDER BY PHONE OR BY POST



Please rush me — Epson P-40 Micro Printer/s for use with _____
and _____ boxes of Epson thermal roll paper. 11m roll

Name _____

Address _____

Tel No: _____

The Epson P-40 thermal printer costs £99.95 (inc VAT).
A box of Epson Thermal roll paper costs £9.95 (inc VAT) — 5 rolls.
Please add £3.00 for postage and packing. Please allow 28 days for delivery.

You can pay for your P-40 micro printer by cheque or by credit card.

I enclose a cheque for £ _____

My credit card no is _____



DE

Data Efficiency Ltd

To order your Epson P-40 now,
just phone 0442-60155
and ask for Angela.

**(0442)
60155**

From Page 76

types are possible but we shall ignore them here.

At the service entry we place this routine:

```
.serviceentry
PHP          save status register
             before it's changed
             by CMP
CMP #4
BEQ unrecomm if A=4 goto
             unreconnised command
             routine

CMP #9
BEQ help     if A=9 goto *HELP
             routine

PLP          if none of these restore
             status register

RTS          return control to
             address on top
             of stack
```

Next we must enable the ROM to identify itself on a *HELP command. All registers must be preserved to enable other ROMs to be presented with the same information.

```
.help        stack holds status
             reg and RTS address

PHA
TXA
PHA
TYA
PHA          stack holds Y,X,A reg.
JSR osnewl  print blank line
LDX #0
.titleloop  print RAM 1.00
LDA title,X i.e. 8 bytes
JSR oswrch
INX
CPX #8
BNE titleloop
JSR osnewl
.out        return control with
             all registers
             preserved

PLA
TAY
PLA
TAX
PLA
PLP
RTS
```

A development of this – not shown here – could enable the ROM to display its own commands and syntax on entering *HELP RAM.

Where, on entry, the accumulator

contains 4 the X register will hold the ROM number (probably 15). Locations &F2 and &F3, offset by the contents of the Y register, point to the start of the unrecognised * command which has occurred, for instance, in a Basic program or which may have just been typed at the screen.

Again, all registers must be preserved in case the ROM does not wish to provide any service.

This program detects whether the * command it is looking at is *RAM. If it is control is passed to the demonstration routine. If it is not an orderly exit is made.

```
.unrecomm    stack has status
             reg and RTS address

PHA
TXA
PHA
TYA
PHA
LDX #0
.unrecogloop compare
LDA (&F2),Y  unreconnised
CMP title,X  command with *RAM
BNE nothisrom
INY
INX
CMP #3       check for 3 letters
BNE unrecogloop
LDA (&F2),Y
CMP #ASC("L") if RAML go to
BEQ languageentry language entry
JMP demonstration if not *RAML goto
             demo program

.nothisrom
JMP out      orderly exit if
             not *RAM
```

When the service has been provided, the stack should be cleared and control returned with the accumulator set to 0 which indicates to other ROMs that the service has already been provided.

```
.exit
PLA          pull registers
PLA          off stack
PLA          - including
PLA          status register
LDA #0      service provided
RTS         return to BASIC
```

Any number of commands may be added in this manner by providing a routine at .unrecogloop to compare the unrecognised command with a table of possible commands.

A language entry does not expect to

return to Basic – the ways to do this are either by providing a special command within the language or by a hard break. A soft break will enable you to stop executing your language (rather like Esc does in Basic) but without actually leaving the language.

The method of language entry used here is for a language command to be explicitly used – *RAML. On recognising *RAML, the ROM will start itself up as a language by performing an OSBYTE call (&8E, with the X register holding the ROM number).

```
.languageentry
LDX &F4      &F4 holds ROM no.
LDA #&8E
JSR osbyte
```

This call marks the ROM number as the one to be selected on a soft break and then displays the ROM name. The ROM is reentered (a JMP not a JSR) with A=1 (the normal language startup code) via the ROM's language entry point.

Writing a language properly is a long job and so is not described any further.

The complete listing is given again and includes a useful demonstration routine which prints out a hex and Ascii dump of the memory of your RAM at &8000 onwards.

Key in the program and RUN it. Press Break. Now enter *HELP and you should see that the ROM identifies itself.

Enter *RAM and the demonstration utility will print out the starting address of each group of eight bytes, then these bytes, first in hexadecimal (for example &41) and then the equivalent in Ascii, say A.

Control characters and user defined graphics are printed out as a dot. Press the space bar for another block of eight lines or press any other key to return to Basic.

Write a short program such as:

```
10 PRINT "address hex      ascii"
20 *RAM
30 PRINT "end of hex dump"
```

This shows that the new command is available both directly at the screen and from Basic programs.

Now you have a good excuse to get into machine code programming. So go to it!

**Full listing is
on Page 168**

BBC AND ELECTRON

VERSIONS FOR CBM 64 & SPECTRUM SOON!

SPACE STATION ALPHA

A GRAPHICAL SPACE BATTLE

The deadly cylon fleet has reached its destination. Their objective - destroy planet earth. Each ship in the fleet carries a single devastating lithium torpedo. Earth shields are up but their power is being drained. You, as commander of earths last remaining space station are all that stands between the cylons and earths total obliteration.

£7.95



SPACE STATION ALPHA



ZORAKK THE CONQUEROR

A GRAPHICAL ADVENTURE GAME

Journey through the medieval lands of Ramagora in search of the three pieces of the long lost crown of Ultimate Darkness. Battle with vicious brigands, avoid the greed of the great dragon, suffer plagues and famine in pursuit of your ultimate goal. This is a graphical adventure in which you play the part of Zorakk and take control of his loyal warriors.

£7.95

SOON

SOFTWARE

65 HIGH STREET, GOSFORTH, TYNE & WEAR, NE3 4AA.
TEL: (091) 2846966

AVAILABLE FROM ALL GOOD COMPUTER STORES,
OR DIRECT FROM US!

TRADE ENQUIRIES WELCOME

ATTENTION PROGRAMMERS!
WE PAY EXCELLENT ROYALTIES FOR ORIGINAL EXCITING PROGRAMMES ON BBC, ELECTRON, CBM 64 & SPECTRUM

Please send me the following items

ZORAKK.....ELECTRON BBC I enclose cheque/P.O.

ALPHA.....ELECTRON BBC for £

Name _____ Address _____

VAT/PP Incl. _____

Bulldozing through to Ithica, beset by many bugs

THE Pen and the Dark by Mosaic is a Basic program (so BREAK, OLD, LIST) with simple verb/noun commands plus occasional prompt. And you get the complete story on which the game is based in a booklet.

It should be easy, but it ain't because it has a few bugs and also involves four or five trips over the same ground, plus some quite complex manipulation involving what I call the "dropped pearl" trick.

That is, you do something in one room (open clam) and an object (a pearl) "appears" in some other room.

The program is full of this trick and it

takes hours to sort out because you are not allowed to anticipate the plot.

Your name, who sent you and your profession — unorthodox engineer — is given in the story and coded in line 3980. The author must have a suspicious mind.

Your task is to bash your way, using random force and ignorance, into a mysterious dark column of negative energy on the planet Ithica. Incidentally, negative temperatures are possible — lasers "cool" when energy is injected.

Working backwards, and from the story, you have to get some light to the penumbral edge of the dark (Room 35).

Nuts to Diaphantos

IF you want a game for kids under 10 then you might try Castaway by Simonsoft. It contains lots of pretty pictures, nice sound effects and silly logic, plus the real boon that you get a complete solution which you can hide from them.

I never know how hard a game is when given a solution. (Would I have ever thought of doing that?) So I belted through it, got stuck in a swamp maze and forgot not to go down.

Talking about mathematical puzzles and castaways, I've decided that this month you lot can write the clever program to solve a problem that has baffled thousands before the home micro appeared...

Five men and a monkey called Diaphantos were castaway on an island. They spent the day collecting a

pile of coconuts and then went to sleep.

In the night one man woke, divided the pile into five equal parts and threw a spare coconut to Diaphantos. The man then hid his share and went back to sleep.

Each of the other four men did exactly the same. Came the dawn and the men divided the remaining pile exactly between them.

Now I've always felt sorry for the monkey who only gets five coconuts when the final pile could have been split six ways, so in my version there are five men and three monkeys in a union.

Each monkey gets five coconuts during the night — 15 in all — but their leader insists on an eight way split in the morning.

How many coconuts did the monkeys get this time?

Alice through the VDU

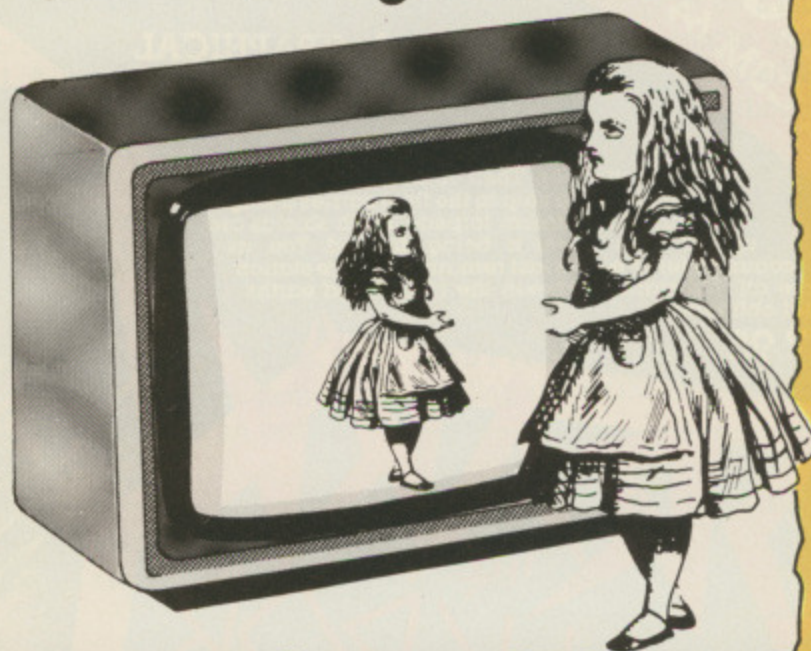

Our monthly foray into Adventure games

I got the generator and the laser both connected, but the program still said I needed light because the connector had somehow been dropped in the previous room (29) and the program wouldn't let me pick it up again or disconnect anything.

Another bug was that whenever I lifted something the object seemed to follow me around.

There are a few other funnies. Driving the crawler is hard work — why not use the arrow keys? — so I got into the habit of only using three letter words.

These were adequate most of the time but occasionally misunderstood, and I still can't fathom how you legitimately discover the allocation code.

One unusual feature is that you cannot QUIT or be killed in this game, so the SAVE is doubly useful.

Despite the bugs the game is a clever adaptation of the story with some neat touches. You get one wish granted at the fountain and a "pearl" drops in the office. And there is only one red herring.

There is hardly any HELP in the game and you have to learn to use some quite unusual words, plus appreciate that the opposite of LIFT is not DROP.

A hint sheet is available from Mosaic for those who have grown weary of the rough ride back and forth on the road to Bethlam.

Actually I think Louis Wu in "Ringworld" was a lot more unorthodox at solving engineering problems and a sniff of the tree of life would certainly be more interesting than drinking Ithican wine. The ring of pearls you'd then see would be a lot more difficult to shift and modify.

Have fun with 5 4 and 12

To solve the MOD2HEX safe puzzle in the July edition of *The Micro User*, dial the three co-prime numbers 7, 11 and 13 and you get three results A, B, C.

These are unique and could be used in a three-dimensional lookup table ($7*11*13$). But more elegant is $XXX=(715*A+364*B+924*C) \text{ MOD } 1001$.

The first correct answer came from Brian Ellsmore of Christchurch, Dorset, who wrote: "Ah! But where do these numbers come from you may ask". Then he showed how he derived them,

finishing with: "Wasn't that fun!".

The proof uses some elegant maths invented by Gauss and beyond the scope of this article, but knowing the answer may help others to sort it out. Note that:

$$\begin{aligned} 1001 &= 7*11*13, & 715 &= 5*(11*13), \\ & & 364 &= 4*(7*13) \\ & & & \text{and} \\ & & 924 &= 12*(7*11) \end{aligned}$$

so all you really need to derive or remember are the numbers 5, 4 and 12. Have fun.

Talking of pigs in opposition..

A Mathematical Adventure by the Association of Teachers of Mathematics contains Fibonacci phones, Platonic solids, pigs in opposition, codes, opening safes, weighing problems and filing blank keys.

It reminds me of a friend of mine who gave a talk about his chess program – probably the best in Europe at the time – and was told by some creep afterwards that his talk had mentioned everything the creep intended to put in his own program.

You may have guessed that I like mathematical puzzles (thanks to Uncle Charles and, more recently, Martin Gardner) where a few lines of text can set a problem that takes weeks to solve.

An example is: *Find integer solutions for I, J and K where $I\Lambda 3 + J\Lambda 3 = K\Lambda 3$.*

This program starts off with you and your boring old sister reading her boring old book – definitely *déjà vu* and still no pictures.

Then you're into the palace with lots of text describing the rooms. This is rather slow because they are pulled off disc, but it's so easy to SAVE and LOAD.

I'm not allowed to give anything away, but I can solve most of the puzzles from memory. I still had to look up the old Sam Lloyd problem of how to plant nine trees in 10 rows of three trees each.

Graphics, in this case, really do add a

new dimension to the game because they can present some nice geometrical problems.

I would have liked to have seen the ball bounce on the oval billiard table but, of course, it is much easier to pot than on a round table.

Uncle Charles once remarked that the regular polyhedra are "provokingly few in number", which is certainly true when it came to using them to map the turtle's maze.

I also had quite a job finding the rope ladder after the owl flew off with it – another "dropped pearl".

I liked it and there is no point in cheating because the answers are not in the program.

Lowdown on programming adventures

IF you think you have some great ideas for an adventure, but don't know how to program, then get the book "Exploring Adventures on the BBC" by Peter Gerrard.

Although the author has converted it from another micro – hence a few niggles – he has broken the process up in a logical and interesting way.

First he discusses some old classics – in particular Colossal Cave – to give some flavour of how to play and solve them. To do this he has given quite a few answers to Colossal.

Unfortunately some are incorrect. You shouldn't get the batteries and you don't draw maps to solve twisty mazes.

He then introduces the main program in the book, Underground Adventure. He gives a list of all the verbs and nouns in the game so that you can follow how the verb/noun commands are processed and applied.

This requires a short introduction to some relevant Basic commands.

Because he is converting to the BBC he tends to dismiss PROCs as named GOSUBs but, as his programs never pass any parameters, this is possible.

Because Basic lacks a CASE statement, I always look for an ON [verb] GOSUB to handle the actions and movements. And there it is on page 102 – all the usual words like GO, GET, DROP, etc.

Oddly enough he doesn't have DIG, but he does include REFLECT and SPRAY which makes him raise the important question of how you get the player to use unusual words. His answer is to provide hints whereas some other games give you a list of words when asked for HELP.

Chapter six deals with the verbs one at a time. You get a copy of the listing in each case – no typesetting errors – with

an explanation of what each line does and why. In this way you get a clear idea of the purpose of the various parts of the program.

Finally, having typed and possibly understood all the bits of the program, you then enter the data for the 100 rooms plus directions "between 1 and 4?".

There is also a short explanation of how objects are placed or dropped in the rooms and that's it.

The author has indeed presented "clearly and logically a complete adventure".

There are two more adventures in the book and all three are available on a cassette for those who can't type.

Although slightly dated – circa 1982 – it's the best and most accurate book I've seen so far on how to program a traditional game.

Alice

DISKING NEWS

We ship the worlds' best diskettes FASTER than anybody. We ALWAYS enclose a VAT invoice and current price list. It's not "Yes sir we're expecting delivery in 4-6 weeks" or "Please allow 28 days for delivery" - What rubbish we put up with in the U.K.?! Just ring another company in this magazine - we did. We purchased a modem advertised on another page - two months later we've still no modem OR explanation, AND we can't leave a message they've no answering machine! EVERYTHING you see in this ad. is ON THE SHELF NOW. We despatch within FOUR working hours or we'll ship FREE!! Write or call (24 hrs) for our general price list. Coming soon:- The new Microdisk SEE 10 library box PLUS Disking Business Diskettes - They'll blow your mind.

FREE with EVERY ten-pack of diskettes from DISKING SEE 10 LIBRARY BOX

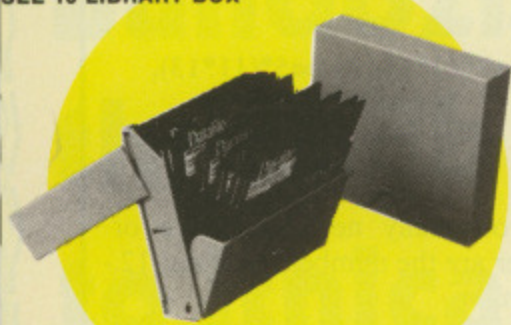

The award winning device for storing and displaying ten diskettes. Available individually at £2.50 exc VAT see under 'Diskette Storage'.

PLUS DISKING COLOUR CODERS



A multicoloured pack of ten fibre tipped pens for colour coding your diskette labels available individually at 49p per pack of ten exc VAT.

DISKING SUPER PROMOTION FREE CLOCK VALUE £8.95



With every TWO Ten-Packs* of ANY 3 1/2", 5 1/4" or 8" disks by Verbatim, Memorex, Dysan or Maxell purchased at these prices, we will pack a Super Disking Calendar Clock worth £8.95 absolutely FREE.

Order four Ten-Packs, and you will receive two Calendar Clocks and so on.

*Excluding diskettes purchased from bargain corner. All FREE offers are subject to availability.

MEMOREX



MEMORY EXCELLENCE

Memorex diskettes are everyone's favourite, and work well in ALL computer systems.

5 1/4 INCH DISKETTES

Certified for single OR double density and with hub ring reinforcement.

PRICES EXC VAT	10-40	50-90
3481 S/S 48 tpi	21.90	20.90
3491 D/S 48 tpi	27.90	26.90
3504 S/S 96 tpi	27.90	26.90
3501 D/S 96 tpi	35.90	34.90

48 tpi suitable for 35 or 40 track operation
96 tpi suitable for 77 or 80 track operation
10 and 16 Hard Sector available at same prices

MEMOREX 3 1/2" MICRODISKS - HERE AT LAST!

PRICES EXC VAT	10-40	50-90
6100 S/Sided	42.90	41.90

0.5M Byte rating auto shutter
3 1/2" library boxes coming soon

FREE



To celebrate three successful years with Memorex we are giving away Memorex C-90 cassette tape with every ten-pack of Memorex floppies. This offer does not affect any of our other promotions, and is in addition to them.

DISKING

DISKING Means Business

NEW DISKING SWING LID BOX for 60 minidisks, comes with keys, dividers, tags and even built in carrying handles. At our price the best value around - Recommended Price £22.50.



D.S.L.B. - £17.90
buy 3 and get fourth one free. Post & Packing at 4 unit rate.

DISKETTE STORAGE



ABA lockable diskette storage comes in two sizes each for the mini disks and 8" disks. They hold either 40 or 80 diskettes.

M35 - 40 mini disk capacity £14.90
M85 - 80 mini disk capacity £18.90
F40 - 40 8" diskette-capacity £18.90

SEE 10 LIBRARY BOX Free with every pack of ten diskettes this superb storage device keeps dust out, yet enables instant selection.



Part No.	Description	Price
SEE 10	Library Box	2.50
LB8	Library Box (not SEE 10 design)	3.00

DISKETTE ACCESSORIES

'PERFECT DATA' CLEANING KIT

The one that really works well in ALL drives - get it now before the gremlins strike.



Part No	Description	Price
CK5	For 5 1/4" disk drives	14.90

5 1/4" DISKING SUPERMAILERS

Very rigid copyright design, takes up to 4 disks.

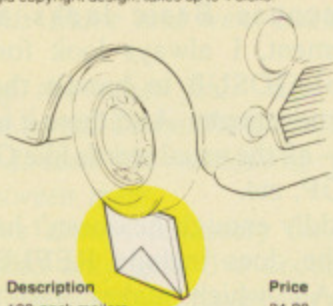

Part No	Description	Price
DSM	100-pack mailers	24.90

DISKING DISKWRITERS

Packed in 25's and sold in 50's, these superb blue or black pens are 100% for use on diskette labels. Please state ink colour when ordering.

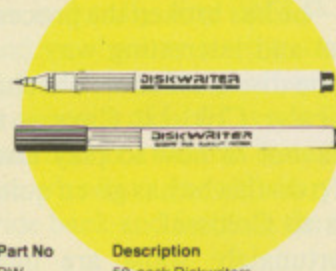

Part No	Description	Price
DW	50-pack Diskwriters	9.90

U.K. SHIPPING RATES INC. INS. BUT EXC VAT

5 1/4" or 3 1/2" DISKETTES 1-2 packs each pack at 95p 3-5 packs each pack at 75p 6-9 packs each pack at 60p 10+ packs POST FREE	5 1/4" SEE 10 LIBRARY BOXES 1-4 off at 40p each 5-9 off at 30p each 10+ off at 20p each	8" CLEANING KITS same as 8" diskettes	LOCKABLE STORAGE (all versions) 1 off 2.00 each 2-7 off 1.30 each 8+ off POST FREE
5 1/4" CLEANING KITS same as 5 1/4" diskettes	8" DISKETTES 1-2 packs each pack at 1.60 3-5 packs each pack at 1.20 6-9 packs each pack at 90p 10+ packs POST FREE	8" LIBRARY BOXES 1-4 off at 60p each 5-9 off at 45p each 10+ off at 30p each	DISKING COLOUR CODERS 25p each - 5+ POST FREE
		DISKING SUPERMAILERS 100-pack 3.00	DISKING DISKWRITERS 50-pack 1.00

Dysan



DYSAN - FOR THE DISCERNING

With new lower prices, Dysan's impeccable reputation is now a genuine bargain.

5 1/4 INCH DISKETTES

Certified for Single OR Double Density. 48 tpi with Hub Ring reinforcement.

PRICES EXC VAT	10-40	50-90	100+
2041D S/S 48 tpi	23.90	22.90	21.90
2042D D/S 48 tpi	34.90	33.90	32.90
2041D S/S 96 tpi	34.90	33.90	32.90
2042D D/S 96 tpi	42.90	41.90	40.90

48 tpi suitable for 35 or 40 track operation

96 tpi suitable for 77 or 80 track operation

10 & 16 Hard Sector available at same prices.

8 INCH DISKETTES

PRICES EXC VAT	10-40	50-90	100+
2701D S/S D/Dens	32.90	31.90	30.90
2702D D/S D/Dens	40.90	39.90	38.90

32 Hard Sector available at same prices

maxell



MAXELL - THE GOLD STANDARD

Maxell's very high quality control ensures all standards are met and surpassed.

5 1/4 INCH DISKETTES

Certified for Single OR Double Density. All with Hub Ring reinforcement

PRICES EXC VAT	10-40	50-90	100+
MD1-D S/S 48 tpi	24.90	23.90	22.90
MD2-D D/S 48 tpi	32.90	31.90	30.90
MD1-DD S/S 96 tpi	32.90	31.90	30.90
MD2-DD D/S 96 tpi	42.90	41.90	40.90
MD2-HD D/S 1.6MByte	59.00	56.00	53.00

48 tpi suitable for 35 or 40 track operation

96 tpi suitable for 77 or 80 track operation

8 INCH DISKETTES

PRICES EXC VAT	10-40	50-90	100+
FD1-128 S/S S/Dens	29.90	28.90	27.90
FD1-1XD S/S D/Dens	34.90	33.90	32.90
FD2-XDD D/S D/Dens	39.90	38.90	37.90

Verbatim



DATALIFE - FIVE YEAR WARRANTY

The world market leaders, with perfect data retention time after time - for a lifetime.

5 1/4 INCH DISKETTES

Certified for single OR double density and with hub ring reinforcement.

PRICES EXC VAT	10-40	50-90	100+
MD525 S/S 48 tpi	22.90	21.90	20.90
MD550 D/S 48 tpi	29.90	28.90	27.90
MD577 S/S 96 tpi	28.90	27.90	26.90
MD557 D/S 96 tpi	36.90	35.90	34.90

48 tpi suitable for 35 or 40 track operation

96 tpi suitable for 77 or 80 track operation

10 & 16 Hard Sector available at same prices

8 INCH DISKETTES

PRICES EXC VAT	10-40	50-90	100+
FD34-9000 S/S S/Dens	31.90	30.90	29.90
FD34-8000 S/S D/Dens	31.90	30.90	29.90
DD34-4001 D/S D/Dens	36.90	35.90	34.90

32 Hard Sector available at same price

20-M BYTE HARD DISKS FOR YOUR MICRO

Part No:	5-MB	10-MB	15-MB	20-MB
DS505	DS510	DS515	DS520	
Prices exc VAT				
APPLE II	1190.00	1290.00	1390.00	1490.00
IBM-PC	1290.00	1390.00	1490.00	1590.00
SIRIUS/VICT.	1190.00	1290.00	1390.00	1490.00
EPSON QX10	1190.00	1290.00	1390.00	1490.00
DEC LSI 11	1390.00	1490.00	1590.00	1690.00
Z80 System	1190.00	1290.00	1390.00	1490.00
S100 System	1290.00	1390.00	1490.00	1590.00

Slaves may be added at these lower prices

990.00	1090.00	1190.00	1290.00
--------	---------	---------	---------

Complete with intelligent controller, host adaptor, power supply unit, fan, cabling, software and User Manual. Free delivery in the UK.

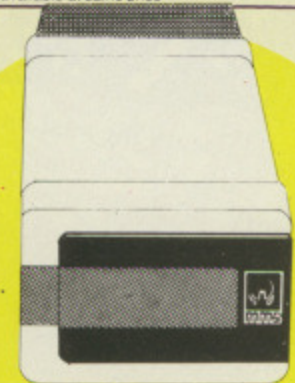

DISKING INTERNATIONAL
FREEPOST
LIPHOOK
HAMPSHIRE
GU30 7BR
UNITED KINGDOM

How to Contact
By Telephone
By Telex
By Prestel
By FAX

DISKING
(0428) 722563
858623 Telex
Page 2477310
(0252) 721521

OFFICIAL GOVERNMENT ORDERS WELCOME

We supply all Government bodies including Schools, Universities, Colleges, Hospitals, the Utilities, Research Establishments, Armed Forces, the Ministries and Local Authorities world-wide. We will despatch within 4 (YES 4) working hours from receipt of your official order number received either by post or by telephone, and all orders are handled in the strictest confidence and to the letter. All other customers cheques with order please payable to DISKING. If you are a large establishment, and cannot raise cheques without an invoice please post or telephone us your order, and we will send a pro-forma invoice by return, for your accounts department to pay against.

CREDIT CARD ORDERS

All orders left on the answering machine qualify for a FREE Disking Logobug to stick on your computer.

You may call 365 days a year, 24 hours a day and you may speak for as long as you like, when you leave the following details:-

1. Day-time telephone number
2. Cardholder Name & Address
3. Delivery/Invoice Address if different
4. Your credit card number
5. Part nos. and quantity of your order
6. Normal or First Class post

We welcome Access (Mastercharge), Barclaycard (VISA) and Diners Club International, and there is NO credit card surcharge. Alternatively you may write your C/card No. on your order.

You may leave the rest to US!!

URGENT ORDERS

If you're posting your order, omit the word FREEPOST from our address, and use our normal post code GU30 7EJ and do not forget to stamp it First Class. If you are telephoning your order please make it clear that you wish to pay for your goods to be sent to you by First Class Post.

FIRST CLASS RATES

EXC VAT	5 1/4"	8"
First Ten-Pack	2.00	2.50
2nd and subsequent Ten-Pack	1.50	2.00

TRADE CORNER FREE AEROPLANE

Don't keep sitting there in front of your VDU, get outside and fly our aeroplane. Just call and ask for your flier, and we'll send you our latest trade pack with prices, special offers and sample unlabelled diskette and mailer. We'll also enclose a DPC application form telling you how to buy at our 10,000 prices yet order only in 50's.

BARGAIN CORNER

5 1/4" SUPERLUXE DISK LIBRARIES

Diskette binders at £4.90 each (normally £9.90) p&p 50p each, 10+ post free.

5 1/4" DISKETTES

Supplied in a FREE SEE 10 library box

PRICES EXC VAT	10-40	50-90	100+
S/S 48 tpi Diskettes	13.90	12.90	11.90
D/S 48 tpi Diskettes	20.90	19.90	18.90

Don't be fooled - these diskettes are brand new and come with our normal full money-back guarantee. They are mostly non hub ring labelled or unlabelled BASF, Dysan, Rhone Poulenc, Memorex etc. where the boxes have had the cellophane removed. We are even supplying them in a FREE SEE 10 library box!! At these prices you can't lose - Hurry!

To: DISKING FREEPOST, Liphook, Hants, GU30 7BR, U.K.

Qty	Description	Price exc VAT

Total Goods Value exc VAT

Total Delivery and insurance

Sub Total exc VAT

VAT

Value of cheque payable to Disking

NAME:

ADDRESS:

TEL NO:

Or please charge my credit card No



Access, VISA & Diners Cards Welcome

HUNT THE

DEEP beneath the vast barren plains of Selly Park, Birmingham, is a daunting network of dark, dank caves, where lurks the Wampus. It is allegedly a fearsome creature which spends most of its time asleep.

But beware, it is easily awakened by nosey people and enjoys a human meal – given half the chance. No one who has hunted it and seen it has lived to tell the tale.

Don't be put off by my tale of woe. Will you take on the unenviable task of tracking down this... **THING!** ... and face the hidden mysteries of the labyrinth?

The basis of the game is a long established pencil and paper mathematical puzzle which can be solved with logic and strategy.

There are 60 caves in all on three separate levels. Tunnels connect each cave with its neighbour both horizontally and vertically.

You are provided with a map, and three magic arrows to aid in your quest. You can shoot an arrow at any time and it will enter up to three caves in a row. Should the arrow enter a cave containing the Wampus, the Wampus will die.

During your search, you will receive visible warnings of impending danger.

For example: "Gosh, what a pong, you can smell Wampus" means exactly what it says, and the rest is up to you.

There are more hazards to meet on the way, but if I told you everything it wouldn't be an adventure, would it?

He who has not hunted the Wampus ... has not yet lived; he who has ... has perished.

Alan Denham

PROCEDURES	
IN	Instructions
LOC	Your location
MAP	Draws map
WARNINGS	Warns you of hazards
WAMPUS	Warns you of Wampus
BATS	Random movement
FALL	Kills you
SPID	Traps you, moves Wampus
DEAD	Kills you
KILL	Kills you
EATEN	Kills you
SHOOT	Shoots, counts ammunition, moves or kill Wampus
WIN	Fanfare

VARIABLES	
AR	Number of arrows
WAS	Wampus location
P1\$,P2\$	Pits
B1\$,B2\$	Bats
S1\$,S2\$	Spiders
CLS	Player location
LVS	Cave level
NS,OS,PS,QS,RS,SS	Adjacent caves
AS,BS,CS,DS,ES,FS	Adjacent caves
TS,US,VS	Arrow targets
Other variables are input for immediate use, graphics, or merely counters.	

NEW WAMPUS



Full listing starts
on Page 170

Warning: these game

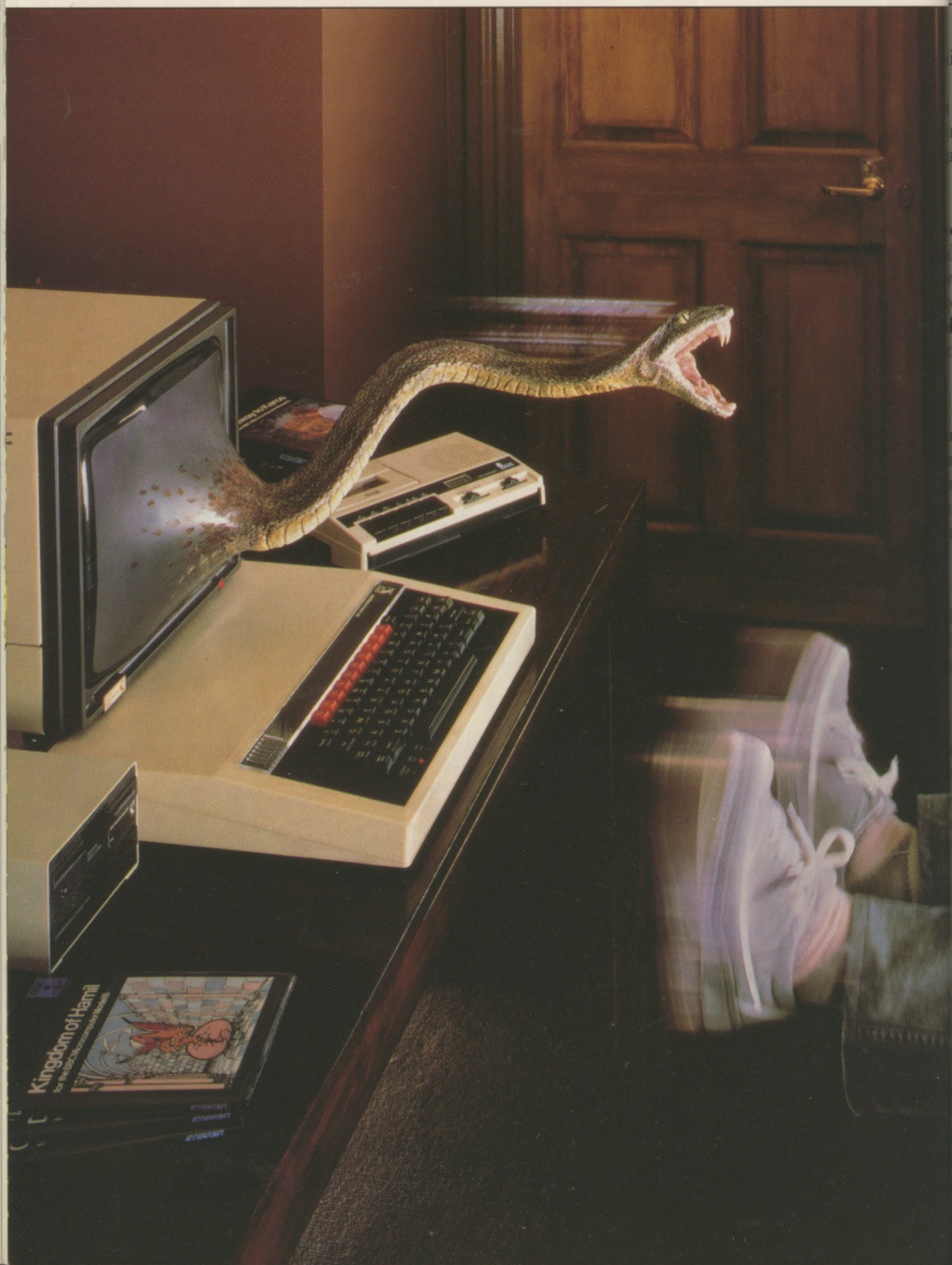

Acon
iless gam
Rang
foot wron
ntics of
laughter.

An a
our patie
bjective i
hichever
erpents l
bundanc
o find you

As th
ou are in
our claim
revent yo
n advent
uzzles an

You'r
iller bees
ou'll have
wn laser l

A gan
inds. Th
our job is
ase. Whil
eak in an
m doing

An a
paint rol
ctangles
destroy
y painting
nning on

Mou
ence. An
helicopter
opes. Tim
e sightse
shoot-t

Games show no mercy.

Acornsoft have now unleashed eight more merciless games onto unsuspecting BBC micro owners.

Ranging from 'Gateway to Karos', where putting not wrong could mean instant death. To the relentless antics of Droгна which could have you dying with a fight.

Gateway to Karos.

An adventure game in which you'll need all your patience and ingenuity just to stay alive. Your objective is to find the Talisman of Khoronz but, whichever path you choose, you'll be beset by treachery. Serpents lie in wait and magical phenomena are in abundance. Should you find the Talisman, you've still got to find your way back.

Kingdom of Hamil.

As the rightful heir to the Kingdom of Hamil, you are in the unusual position of having to prove your claim to the throne. Evil people are trying to prevent you accomplishing your task by any means. This adventure game fraught with many dangers, puzzles and problems.

Tetrapod.

You're in an arena littered with dormant lizards, killer bees and other hostile creatures with whom you'll have to do battle to survive. But beware of your own laser bullets, as they bounce off the arena walls.

Droгна.

A game for two people - preferably with devious friends. There are two vaults containing diamonds and your job is to collect and transfer them to your home base. While your opponent is out collecting you could sneak in and steal his loot... but keep an eye out for him doing the same to you.

Crazy Tracer.

An arcade style game where you're in charge of a paint roller. Guide your roller around a maze of obstacles while evading monsters who are committed to destroying it. Gain extra rollers and bonus points by painting different objects. But you'll have to avoid running out of paint.

Volcano.

Mount Crona has erupted after 150 years of silence. And your mission as an Emergency Rescue Helicopter Pilot is to save sightseers stranded on the slopes. Time is of the essence as the lava approaches the sightseers. But you'll have to take time to evade - shoot - the boulders being hurled from the volcano.

Carousel.

A re-creation of the fairground shooting gallery - with a difference. Shoot down all the ducks, owls and rabbits before you run out of ammunition. Watch out for the low-flying ducks. If you fail to shoot these, they'll steal your bullets and reduce your chances of success.

Meteor Mission.

On an alien planet are six stranded astronauts. Launch your capsule from the Mothership and by avoiding - or shooting - meteors and alien craft, pick up the astronauts one at a time and return them to the Mothership.

All games - with the exception of Gateway to Karos which is currently only available on cassette - can be bought direct in either cassette or disc form. You will find all these programs at your local Acorn stockist. To find out where they are simply call 01-200 0200. Credit card holders, phone 01-200 0200, anytime. Or 0933 79300, during office hours.

Alternatively, you can order the games by sending off the coupon below to: Acornsoft, c/o Vector Marketing, Denington Estate, Wellingborough, Northants NN8 2RL. Please allow 28 days for delivery.

To: Acornsoft, c/o Vector Marketing, Denington Estate, Wellingborough, Northants NN8 2RL.

Please send me the following software games:

<u>PROGRAM</u>	<u>QUANTITY</u>	<u>DISC/CASSETTE</u>
Gateway to Karos		
Kingdom of Hamil		
Tetrapod		
Droгна		
Crazy Tracer		
Volcano		
Carousel		
Meteor Mission		
	TOTAL	

Price Cassette: £9.95; Disc: £11.50

I enclose PO/Cheque payable to Acornsoft Ltd. Or charge my credit charge.

Card Number: _____
Barclaycard/Access (Delete)

Name _____

Address _____

Postcode _____

Signature _____
Registered No. 1524763 VAT No. 215 8123 85

ACORNSOFT

Amazing how played out some things become



ing become.

Will you think the same of your micro in 6 months' time?

Remember the days when every record player was gifted with a needle instead of a stylus. 45's were "in," 78's were "out."

Before the days of hi-fi and laser discs. When a graphic equaliser was a breakthrough on the football pitch instead of in music technology.

Look at a record player now and it's a museum piece.

It's like that with micros too. The machine you thought would give endless hours of fun and interest often becomes a five minute wonder. Played out within months. Or so you thought.

But imagine communicating with other micro users on a nationwide mainframe system. Updating yourself

daily with the very latest computer news and reviews. Paging a special Bulletin Board. Feasting from Prestel's vast menu. Even downloading a choice of software *absolutely free*.

In fact, imagine 30,000 pages at your fingertips and you've imagined what it's like to be on line with the Micronet 800 system.

For just £13 a quarter (and, for most of you, a local telephone call whenever you want to connect up) you could subscribe to the Micronet system.

The only extra you need to connect up is a modem unit. Which is a small enough outlay for what it buys.

Micronet's features are almost limitless and constantly updating so why not see it in action at John Lewis stores, selected W. H. Smith shops and Spectrum UK dealers.

Or fill in the coupon for our brochure.

You'll find you won't want to play on anything else.



Please send me the full facts about Micronet 800.

Name

Make/Model of Micro

Address

Telephone

MICRONET 800, Durrant House, 8 Herbal Hill, London EC1R 5EJ. Telephone 01-278 3143. **MU10**

MICRONET 800, Durrant House, 8 Herbal Hill, London EC1R 5EJ. Telephone 01-278 3143.

*Prestel and the Prestel symbol are trademarks of British Telecommunications.

Making the most of your micro.

CHASE DATA L

PRICES SENSATION

Canon 110: Case/Cables all INCL **£99**

Canon 220: 400K (40/80 switching)

Case/Cables all INCL **£169**

N.B. These are state of the Art Disc Drives; Direct Drive
40 track 6mms Access/80 track 3ms Access.

DFS Kits available
ex stock
all inclusive price **£109**

SLIM CANON DISC DRIVES

MODEL: SPECIFICATION OF EACH DRIVE

110	S/SIDED 40 TRACK 100K
210	D/SIDED 40 TRACK 200K
220	D/SIDED 80 TRACK 400K (40/80 TRACK SWITCHING)

■ All **CANON** 40/80 switchable disc drives feature an on-board dual-colour LED on the front panel to show track mode selected. This is coupled with our own unique two-stage illumination, to give a clear operating status, as follows:

40 TRACK MODE: _____ LED GREEN

80 TRACK MODE: _____ LED RED

POWER ON: _____ HALF-ILLUMINATION (GREEN OR RED)

DRIVE SELECTED _____ FULL-ILLUMINATION (GREEN OR RED)

■ Super-slim **CANON** drives, models 211 and 221 and the **SANYO** model 596D are available with their own **custom-built secondary switching power supply**. This is safe, low in heat generation and excellent value for money.

■ The **SANYO** disc drive is our latest acquisition in quality Japanese products. This is a "half-height" unit of standard dimensions.

ALTD DISC DRIVES

**FOR THE
BBC
MICRO**

SLIM SANYO DISC DRIVES:
MODEL: SPECIFICATION OF EACH DRIVE
596D D/SIDED 40/80 TRACK 400K

SUPER-SLIM CANON DISC DRIVES:
MODEL: SPECIFICATION OF EACH DRIVE
211 D/SIDED 40 TRACK 200K
221 D/SIDED 80 TRACK 400K
(40/80 TRACK SWITCHING)

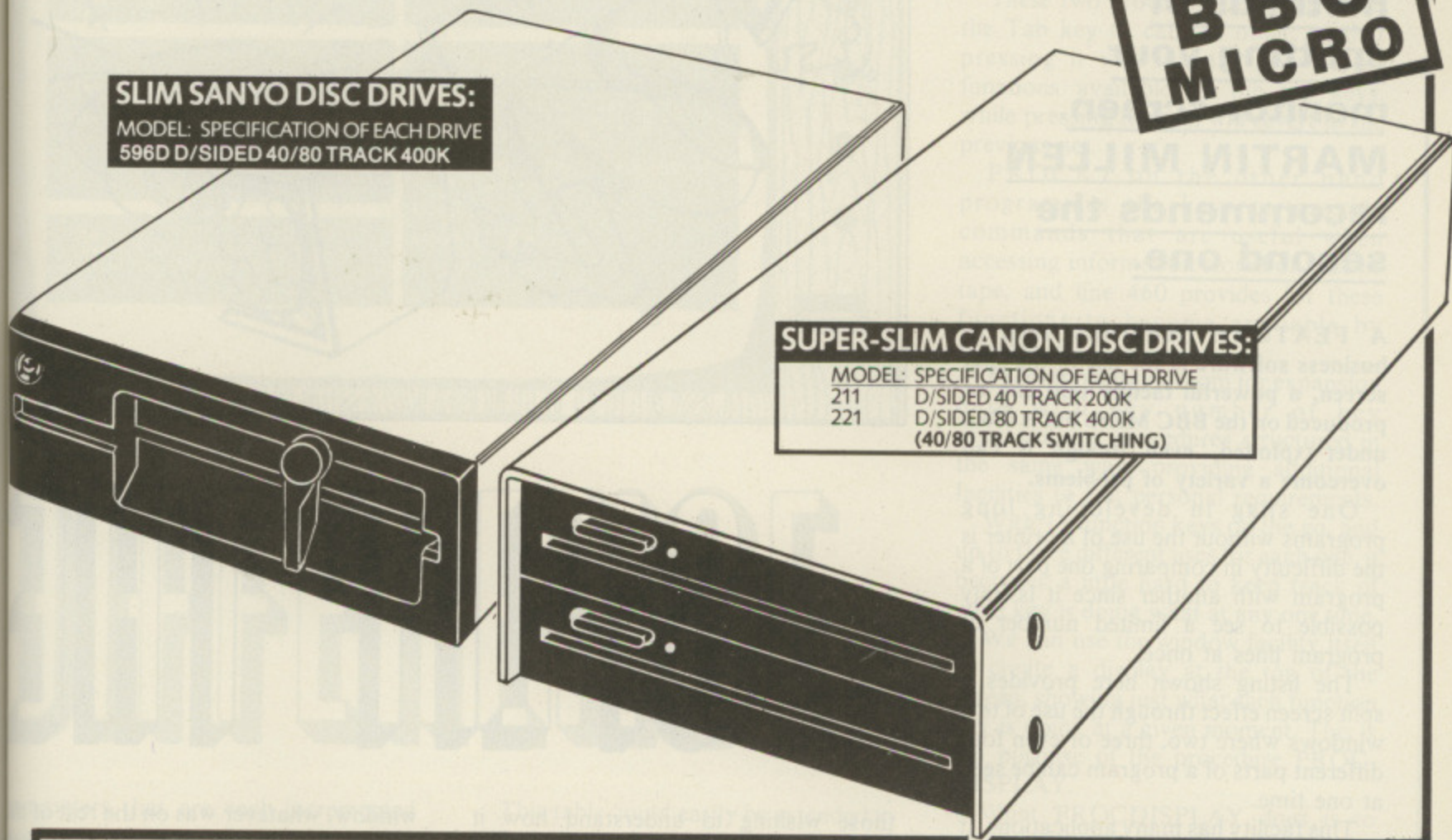

All inclusive price list:

This means: disc drive + case + all power & data cables + U.K. carriage + utilities disc & manual + V.A.T.

MODEL:	CANON					SANYO
	110	210	220	211	221	596D
Formatted Capacity per drive on BBC Micro:	100k	200k	400k	200k	400k	400K
Single Drive & Case:	£99	£139	£169	£179	£236	£182
Single Drive & Case/P. Supply:	£124	£164	£194	£209	£266	£212
Dual Drive & Case:	£204	£274	£314	£329	£437	£368
Dual Drive & Case/P. Supply:	£229	£299	£339	£359	£467	£398

Support:

Warranty: All disc drives sold by Chase Data Ltd. come with a full one-year warranty on parts & labour.

Non-warranty service: As THE experts in our field we can offer service on most makes of floppy disc drive.

Recalibration & Alignment ... £25 per unit inc. VAT. (parts extra). Phone for details: (Tel: 0784 38487)

Payment



By Post: Send your remittance (cheques only please) with your order to:

CHASE DATA LTD

P.O. Box 6, Woking, Surrey, GU21 4PB.

By Phone: (Tel: 0784 38487).



There are two methods of splitting your monitor screen.
MARTIN MILLEN recommends the second one.

A FEATURE frequently seen in business software is the use of the split screen, a powerful facility that can be produced on the BBC Micro but is often under-exploited, even though it can overcome a variety of problems.

One snag in developing long programs without the use of a printer is the difficulty in comparing one part of a program with another since it is only possible to see a limited number of program lines at once.

The listing shown here provides a split screen effect through the use of text windows where two, three or even four different parts of a program can be seen at one time.

This facility has many applications. It is of particular importance in writing structured programs since it permits the programmer to view both a defined procedure and that part of the program which calls it at the same time.

In many cases it is also possible to arrange things so that the relevant part of a listing appears on one screen while the program is running and producing results on another.

A small demonstration of this possibility is included in a procedure called PROCDEMO. However it is only possible to use this particular technique if your program runs in Mode 0.

The different screens are called by the various function keys. In order that the whole should perform as an overall programming aid a number of other useful functions have been incorporated.

The utility is presented as a standalone program, although it is intended to be used as a group of self-contained procedures that may be tacked on to the end of any program under development.

The utility is written entirely in Basic and should present little difficulty to



SPLIT THE DISPLAY

those wishing to understand how it works. It is hoped that some of the techniques may prove of interest for use elsewhere.

It has been structured in such a way that there should be no problem in expanding it to provide other facilities if required.

It should be pointed out, perhaps, that the blank lines such as lines 80, 110, 150 and so on, which have been inserted to improve readability, have in fact got one space in them - to hold them in existence.

At only five bytes per line, this is probably memory well spent. The utility occupies about 2½k and this will normally be acceptable.

By compacting it down, and through the use of multi-statement lines, it could be brought down to within 1k, if this proves necessary.

As everybody knows there is a VDU-command - VDU 28 - that enables text windows to be set up so that only part of the screen is in use. At first sight there seems to be little point in limiting the display to less than the whole screen.

What is not immediately apparent however is that when you define a text

window, whatever was on the rest of the screen beforehand remains unaltered and will stay there until you redefine the text window to include that part of the screen once more.

This is the technique we shall use to split the screen. First we define one window, on the left hand side for example, and display part of the program in it. Then we define a second window on the right and display a different part of the program.

The lines listed in the first text window will remain until we define the second window once again.

By programming the function keys to do all the hard work of calling the window routine and providing the parameters, changing screens can become a matter of pressing a single key.

The procedure that sets up the windows is PROCWINDOW. The four parameters passed to it are the two pairs of coordinates that define the bottom left and the top right corners of the text window.

In fact this procedure is a little more ingenious than you might imagine as it contains not one but two VDU commands, the second of which uses

parameters by plus or minus the first.

The effect of the first window, by changing the window and effectively clearing the window and effectively clearing the window and effectively clearing the window.

The color of the black background gives a white background by the VDU command.

It will be noted that the parameters are conditional and have a specific purpose.

In practice you can call PROCWINDOW more conveniently to be called PROC_VDU with a table of 10 available parameters.

The function call this parameter is to 10. The parameter is WINDOW.

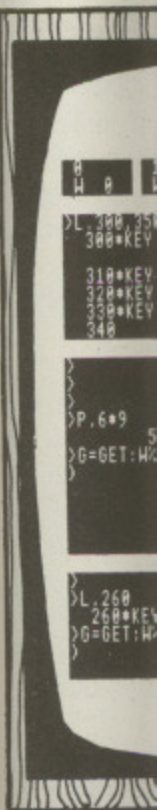

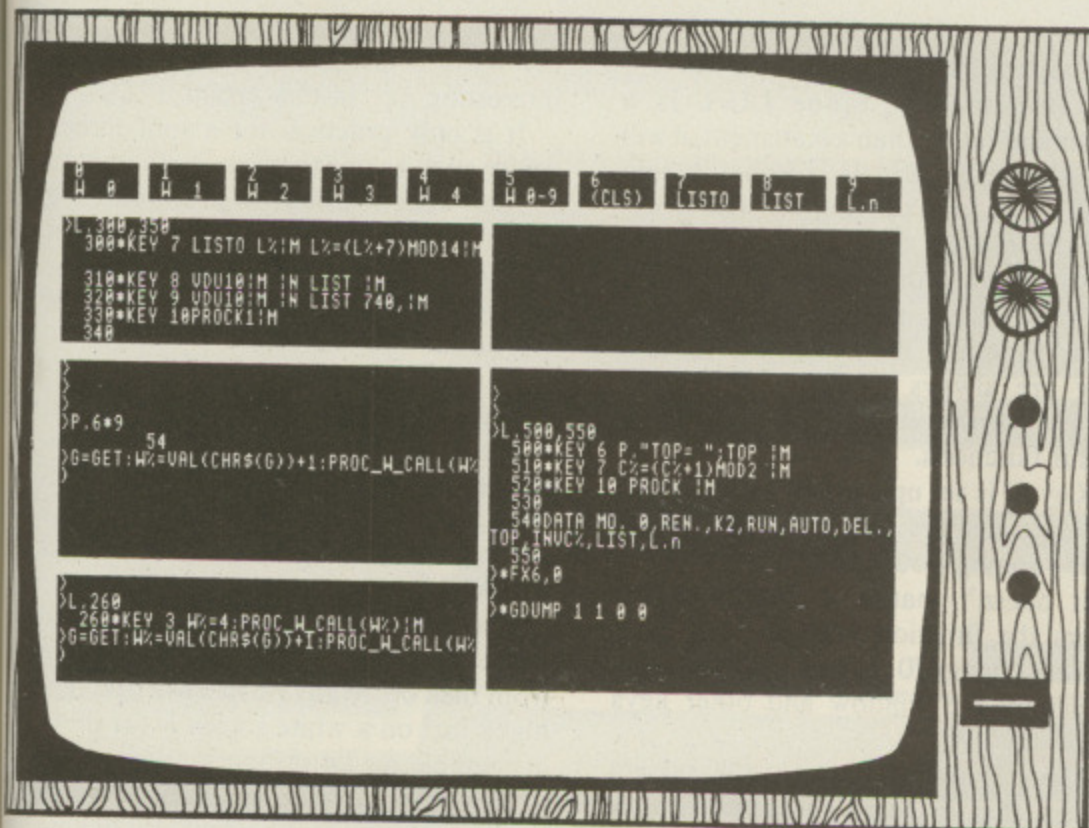

THE DIFFERENCE

est of the parameters that are each incremented by plus or minus one from those used in the first.

The effect of this is to create two text windows, one inside the other. By changing the background colour and clearing the screen between defining one window and the other we have a quick and effective way of putting a contrasting border around the final window.

The command VDU17,128 gives a black background while VDU17,129 gives a white one. The window is cleared by the VDU12 command.

It will be seen that these commands are conditional on the variable V%. The purpose of this will be explained later.

In practice the function keys do not call PROCWINDOW directly as it is more convenient for PROCWINDOW to be called from the procedure PROC_W_CALL. This contains a table of 10 sets of parameters for the 10 available windows.

The function keys are programmed to call this procedure, passing it to the parameter W% which lies in the range 0 to 10. This determines which set of parameters are passed to PROCWINDOW.

This table could easily be extended to include any number of parameter sets to provide windows to suit individual taste. The windows 0 to 4 are made available by pressing f0 to f4 respectively.

The other windows are called by pressing f5, which will then accept a parameter in the range 0 to 9 to call any one of the 10 windows.

It could be arranged, however, for this parameter to specify one of 10 separate windows, not including those called by f0 to f4.

There are only 10 red function keys on the BBC Micro. Often, as in this case, there are more than 10 different functions that it would be useful to have on call.

The statement *FX219,138 on line 200 enables the Tab key to be programmed as f10, giving one extra key, but if as many as 20 or 30 different functions are required from these keys then another approach is needed.

As can be seen from the listing there are three separate procedures that define the function keys - PROCK, PROCK1 and PROCK2 - so that they can be programmed in three different ways.

PROCK enables any one of up to 10

different shaped screens to be called by the red keys, while PROCK1 provides a number of other useful programming functions.

These two procedures each program the Tab key to call the other, so that pressing it will make a new set of functions available on the red keys, while pressing it again will revert to the previous set.

PROCK2 on the other hand programmes the keys to provide commands that are useful when accessing information stored on disc or tape, and line 460 provides for these functions to become available by pressing f2.

There is plenty of room for expansion here with any number of key programming procedures structured in the same way, providing additional facilities to suit personal requirements.

With 11 function keys on the go, and up to three different uses for each one, it becomes a little hard to keep track of what key is doing what at any one time.

We can use the window facility itself to create a display at the top of the screen, showing just what each function key is doing at a given moment. This is the purpose of the procedure PROC-DISPLAY.

What PROCDISPLAY does is to create 10 small text windows - each with its own border round it - and put a logo in each one relating to the respective function key.

It will be seen that PROCDISPLAY is called at the beginning of each of the three procedures PROCK, PROCK1 and PROCK2.

But since we need a string of descriptions to put in these 10 mini windows, the data pointer is first repositioned to the DATA statement at the end of each procedure by the RESTORE command.

The READ command in PROC-DISPLAY will now pick up the correct text for each function key.

Sometimes, when you return to a screen, you might want to keep what is displayed rather than clear it.

For this reason the VDU17 and VDU12 commands are conditional on the value of the variable V% and will only clear a newly defined screen when V% has a value of 1.

This value is set to zero by f6 in PROCK but it is always returned to 1 after a new window is called - this is the

From Page 93

last line in PROC_W_CALL.

The default therefore is to clear each new window as it is created, so if you don't want it cleared you must first press f6 and then the key to create the new screen.

The red key f7 is programmed by PROCK to alter the list options with the LISTO command. Each time you press it, it flips between LISTO 0 and LISTO 7.

This makes it very easy to list with leading spaces and indentations for general clarity, but without them when you wish to edit lines.

Key f8 lists the program in paged mode - the VDU 10 command drops the listing one line, so that the scrolling up which takes place when you next change screen doesn't result in the loss of any program lines from the top of the old one.

Finally key f9 is "hardwired" in line 320 to list from a specific line onwards. If you are working on a particular section of your program you can edit line 320 so that f9 starts listing from the beginning of that section. This is a useful facility

although a little clumsy to set up.

Unfortunately, since LIST is a command rather than a statement, it will not access a variable, so that typing LIST A%, for example, will not work. For this reason, the line number has to be written into the program.

These last two keys are not re-programmed by PROCK1 so that they are always available. The other keys are however, and they give some useful functions.

Key f0 is set up so that, for example, you can get the utility working again after running your program.

It doesn't matter if your program alters the function keys so long as it doesn't change f0, as this is all you need to set up the window and other keys again.

Keys f1 to f5 are fairly self-evident except that in some cases the control and M characters have been deliberately omitted. This permits you to add parameters to the commands before entering them.

Key f6 tells you how much memory has been used. It could easily be arranged for this key to provide more extensive information. This just leaves

f7 which is, perhaps, the most interesting key in this group.

It is only practical for a split-screen utility such as this to work in 80 column mode. When using a monochrome monitor this is probably the mode of choice, but with an ordinary TV set, the clarity of the text in Mode 0 is often not too good.

This can be improved by turning the colour control on the set right down. But a much greater improvement can be made by reversing the text and background colours. This is done automatically by f7 as programmed in PROCK1.

Each time you press it, black and white swap over in any windows set up from then on. Many people will find that black text on a white screen is far more acceptable on an ordinary television.

However you can, in addition, create some quite interesting effects by having some screens one way and some the other, all at the same time. PROC-DEMO shows this in action.

**Full listing is
on Page 178**

FOOTBALL MANAGER

It's here for the BBC Model B

Some outstanding features of the game

- Matches in 3D graphics
- Promotion and relegation
- Injury problems
- Pick your own team for each match
- Financial manipulations
- Transfer market
- F.A. Cup matches
- Full league tables
- As many seasons as you like
- 64 teams and customising feature
- Four Divisions
- Managerial rating
- 7 skill levels
- Save game facility
- You can even be sacked!

Prices: BBC Model B £7.95
Commodore 64 £7.95
Spectrum 48K £6.95
ZX81 16K £5.95

(N.B. 3D GRAPHICS ARE NOT INCLUDED IN THE ZX81 VERSION)

Overseas orders add £1.50

Strategy Game of the Year, 1983
(Nominated)

Golden Joystick Awards

Addictive

Available from computer software stockists nationwide, including

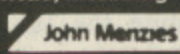
 and 

Addictive Games

7A RICHMOND HILL, BOURNEMOUTH BH2 6HE

£7.95

To order by mail (p&p free) send cheques or postal order to:

most
screen
column
arome
ode of
et, the
en not

ng the
n. But
an be
and
done
ned in

k and
set up
d that
more
ion.
create
aving
e the
ROC-

's
8



Choosing a printer is a lot easier than choosing a computer.

THERE are dozens of quality printers from which to choose. With quality price tags of around £250.

The Brother M-1009, however, breaks all the rules.

Stays defiantly below the £200 barrier.

Though it has far more than its fair share of features, it maintains the extraordinarily low price of £199.95.

Travels at a steady fifty.

In the speed stakes, the M-1009 is certainly no slouch, being fully capable of up to 50 characters per second.

Providing bi-directional and logic seeking printing for normal characters and uni-directional printing for super and sub script and graphics.

Prints on any paper.

Being an impact printer, the M-1009 will print on virtually any paper, including letter headings, invoices and standard office stationery.

It will even print two copies together with your original.

A superb character recommendation.

In its price range, the M-1009 has a great deal more character than many printers.

96 no less, plus international type and graphic characters.

Reliability comes as standard.

Built to the same exacting standards as Brother's elite office

printers, the Brother M-1009 already has faultless credentials for reliability.

Its 9 x 9 dot matrix head, for example, has an astonishing 20 million character service life.

One printer that doesn't block out the light.

Many home computers tend to be a little on the large side. In contrast, the compact M-1009, at only 7 cm high, keeps a discreet profile.

Well designed, reliable – and conscientious.

The Brother M-1009.



The future at your fingertips.

DEPT P, BROTHER OFFICE EQUIPMENT DIVISION, JONES + BROTHER, SHEPLEY STREET, GUIDE BRIDGE, ALDENS HAW, MANCHESTER M34 5JD.
TEL: 061-330 6531 (10 LINES) 061-330 0111 (6 LINES) 061-330 3036 (4 LINES) TELEX: 669092 BROTHER INDUSTRIES LIMITED, NAGOYA, JAPAN.

— AVAILABLE FROM —

BOOTS, W. H. SMITH, WILDINGS, SPECTRUM U.K. MAJOR DEPARTMENT STORES AND BROTHER OFFICE EQUIPMENT RETAILERS. MU10/84

DOUBLE MEASURE...

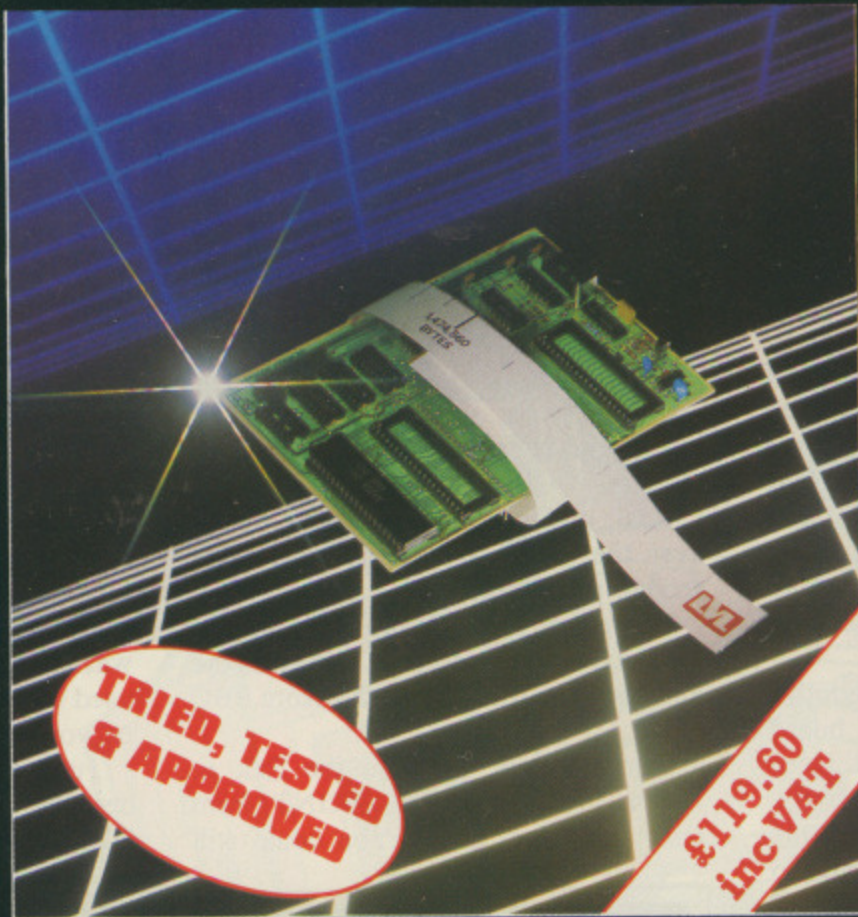

AVAILABLE FROM ALL LVL DEALERS. (FOR FURTHER INFORMATION TELEPHONE 0602 394000)

Twice as much storage capacity on your present or proposed discs.

The LVL *true double density* printed circuit board offers an amazing 1,474,560 Bytes of on-line storage, on a twin 80 track double density drive.

Removed is the 8271; (it is not capable of supporting double density). In its place, a small printed circuit board with a new disc controller and support circuitry provides a much improved data retrieval.

This drastically reduces read errors by using a phased locked loop data separator, which is superior to the standard window circuit.

Your BBC micro will now recognise the media density in the drive, and inform you if it is correct. You may define what density you require, 40 or 80 track, and which sides of the disc to use.

The device gives complete flexibility and comes with an Eprom containing firmware; manual, and a 40/80 track utilities disc. On a dual drive it is simplicity itself to copy existing software from single density to double density.

- Double Density
- Automatically checks for correct density
- No 8271 (Rare & expensive)
- Utilities provided
- Defaults to single density on power up
- 40 or 80 track
- Own PCB with separate 8Mhz clock
- Simple to fit
- User definable density
- Phase lock loop data separator circuit.



Scientific House,
Bridge Street, Sandiacre
Nottingham. NG10 5BA
Telephone (0602) 394000

So
ac
Just fea
quality

NEW
GUN
3D B
SUPE
COM
JOYS
DISTRIB
ENQUIR
Softwar
all SPEC

RI



SUPER
BBC Mi
Acorn E
£7.95 C
£9.95 Di
Author:
J. Leath



50 E

Software Invasion in the accustomed style...

Just feast your eyes on the excitement in store for you. All at the usual quality you expect from the best name in arcade games!

NEW RELEASES FOR THE ELECTRON!

GUNSMOKE

3D BOMB ALLEY

SUPER POOL



Joystick Compatible

COMPATIBLE WITH THE "FIRST BYTE" JOYSTICK INTERFACE!

DISTRIBUTORS, MULTIPLE STORES AND RETAILER GROUP ENQUIRIES INVITED.

Software Invasion Games are available from WH Smith, HMV, all SPECTRUM shops and over 1,000 retail outlets!

NEW RELEASES!

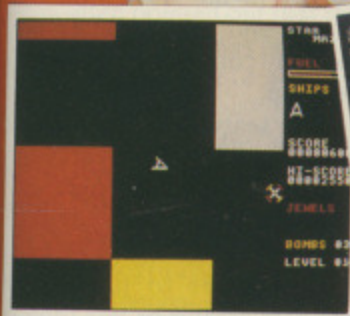

SUPER POOL
BBC Micro 32K
Acorn Electron
£7.95 Cassette
£9.95 Disk
Author: Dr. Robin Leatherbarrow

STAR MAZE
BBC Micro 32K
£7.95 Cassette
£9.95 Disk
Author: K. M. Williams

SUPER POOL
A superb Pool game with a difference! Features include time restricted shots, variable cue strength, superb real time graphics, sound and optional joystick control.
Level 1 Pot balls in any order.
Level 2 Pot balls in correct order.
Level 3 Pot and hit balls in correct order.

STAR MAZE
Travel through the Star Maze to discover rare jewels and transport them back to the mother ship. On the way, your mission is threatened by asteroids, bird hatching Eggs which lay homing mines, rotating alien satellites and alien fighters. Most deadly of all are the maze walls which will vapourise your ship on contact. A very unusual game!

SPOOKS AND SPIDERS
BBC Micro 32K
£7.95 Cassette
£9.95 Disk
Authors: Mr. & Mrs. S. Whiting



3D BOMB ALLEY
BBC Micro 32K
Acorn Electron
£7.95 Cassette
£9.95 Disk
Author: Simon Vout



ATTACK ON ALPHA CENTAURI
BBC Micro 32K
£7.95 Cassette
£9.95 Disk
Author: Simon Vout



VORTEX
BBC Micro 32K
Acorn Electron
£7.95 Cassette
£9.95 Disk
Author: Simon Vout



EAGLES WING
BBC Micro 32K
£7.95 Cassette
£9.95 Disk
Author: Marcus Bott-obi



GUNSMOKE
BBC Micro 32K
Acorn Electron
£7.95 Cassette
£9.95 Disk
Author: Simon Vout



SOFTWARE INVASION

50 Elborough Street, Southfields, LONDON SW18 5DN.

Do you write your own programmes? If you have an unusual programme which can meet our standards you could be earning a substantial sum every week! Why not take advantage of our sought after reputation, Write now!

HOW TO ORDER

You may purchase any of the games above direct. All you have to do is write your name and address on a piece of paper, item(s) required, enclosing your cheque/P.O. made payable to SOFTWARE INVASION.

Please allow 7 to 14 days for delivery. (Orders are normally despatched within 48 hours.) Overseas orders: Please add 0.75p per game.

Now you can use your BBC Micro to write a letter or a report, to compile a mailing list or classify your record collection, to check your bank statement or sort out your family finances (and then translate them into colourful graphics) . . . all for just £5.95.

Quick to learn, easy to use, that's . . .

MINI OFFICE marks a long-awaited breakthrough in dramatically reducing the cost of personal computing.

For the first time it makes available to everyone an easy-to-operate version of four of the most popular business computing applications – and at a price anyone can afford.

Never before has a word processor been sold for anything as low as £5.95. Nor a database manager. Nor a spreadsheet. Nor a graphics program.

Yet Mini Office contains them all.

So how was it done?

It all started with a suggestion that we should prepare a package to give readers a gentle introduction to the kind of software that businesses were running on their computers.

At that stage there was no intention that it should be an ambitious package. Just a simple program that could be sold at a very low price.

We called in experts in business software programming, told them what we wanted and sat back to await results.

What happened next was

suite of programs covering all four applications.

In fact the only part of the brief that remained was our original insistence that the package should be quick to learn and easy to use.

And despite all the extra sophistication that has been written into it, we decided that, as a service to our readers, the price should still be kept at the very low figure originally fixed.

How does Mini Office operate?

Using the **Word Processor** is simplicity itself. There are none of the cryptic coded instructions that had to be mastered by people learning the early word processors.

You start by selecting the size of type you prefer – either normal or double-size. The latter is a feature that you cannot find on any other word processor.

It is particularly suitable for the partially sighted – in many

perfectly typed letter without outside help.

Primary school teachers are also expected to make great use of the double-size function, both

information. It can be retrieved in its entirety or just the part you require for a particular purpose, whenever you need it.

The operation is so simple

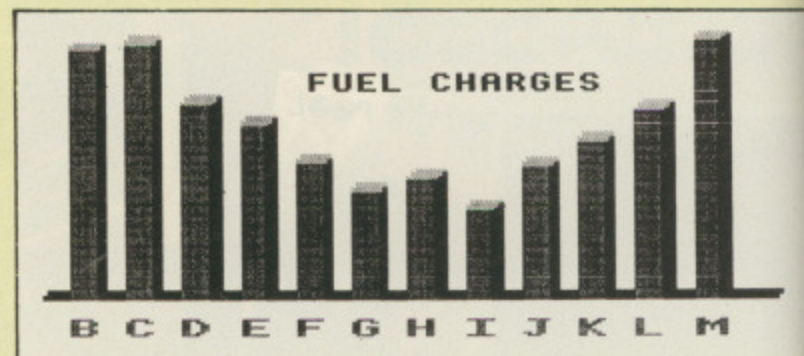

Figures on the spreadsheet can produce a bar chart . . .

on the screen and on hard copy printouts.

While you are using the word processor three useful pieces of information are displayed across the top of the screen.

They tell you how much time has elapsed since you started using it, the number of words you have written so far, and how many characters you can key in before the BBC Micro's memory is full.

At any time you can press a key which tells you your typing speed. This is a most useful function, and can play an important part in increasing your efficiency at the keyboard.

You can also decide the size of the margin, the line length and the tab positions. Text can be moved from one part of the document to another.

At any time you can preview the text to see how it would look when printed out.

As with all the other programs in Mini Office, your work can be saved to tape or disc and loaded when you want to use it again. It can also be printed out.

The **Database** program can be used to store a mass of

that a useful database can be created in minutes rather than days – and you certainly don't need any computer experience to set it up.

The search facility is very easy to use. You can search for a particular word or part of a word. Or you can order a numeric search – such as telling the computer to find all the numbers greater or less than the one you provide.

You can carry out multiple searches. For instance, if you have built up a mailing list containing a list of names, addresses, telephone numbers, occupations and ages you can ask the database to provide you with a list of teachers living in Liverpool whose ages range from 25 to 30.

One powerful option allows you to replace anything on the database without having to go through the whole lot making amendments yourself.

You could, for instance, instruct it to find each reference to "teacher" and replace it with "lecturer".

The **Spreadsheet** is our version of the program that marks

A unique feature is the double size text option in both printer and edit mode – perfect for young children and people with poor vision.

The word processor – with double size characters

totally unexpected. For they all came back with ideas that were to considerably expand our original brief.

In the end what had been planned as little more than a beginners' guide to word processing, database management, spreadsheets and graphics had been turned into a full scale

cases giving them their very first opportunity to use a word processor.

This means they can use a BBC Micro to compose a letter, using the double-size mode, and then print it out using normal size type.

For many people this could be the first time they can send out a



retrieved,
the parts
particular
need it.
simple

can be
er than
ly don't
eience to

is very
rch for a
rt of a
rder a
s telling
all the
than the

multiple
if you
ing list
names,
numbers,
you can
vide you
iving in
s range

allows
g on the
g to go
making

stance,
eference
e it with

our ver-
marked

an important milestone in business computing – Visicalc.

It is often pointed out that this one program alone has helped to sell more personal computers than any other.

Certainly Visicalc and its derivatives have never been shaken from their position at the top of the list of best-selling business programs.

Yet the concept is very simple – a giant worksheet of rows and columns, only part of which can be seen on your screen at any one time. Into any position on the sheet you can put numbers, labels and mathematical formulae.

And when you alter any figure its effect ripples through the rest of the sheet, changing any totals as may be necessary.

The Mini Office version is ideal for home finance, providing you with an effortless means of keeping tabs on your income and expenditure – and enabling

you to work out your own budget.

In our Spreadsheet program – as well as in the Database – we have provided a sample file so

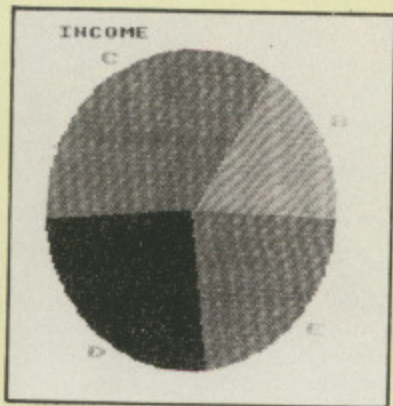

... or a pie chart

that you can experiment with it before entering your own data.

One feature we have included which to our knowledge does not exist in any other spreadsheet is a warning device to prevent you accidentally erasing formulae – a very useful precaution.

The **Graphics** program uses the standard business graphics – line, bar and pie charts – in full colour. Which is something not always available on far more expensive graphics packages.

The program uses data you have already prepared on the spreadsheet. You have to identify which set of information you require to see in graph form – such as by indicating which row or column – and then which of the graphs you require.

The graph is then automatically configured exactly as you require it. If you have an Epson-compatible printer capable of producing graphics you

can also print out hard copies for a permanent record.

Because our original intention was to produce a package for people new to all these applications, we have produced a fully-detailed, easy to understand manual.

This 32 page free booklet gives clear instructions about how to use all four programs and in itself forms a concise introduction for first-time users.

If you want to start doing more with your BBC Micro than just playing games, this package is your ideal introduction to the four most popular applications for professional computers.

Send for it today

Please send me _____ copy/copies of
Mini Office

I enclose cheque made payable to
Database Publications Ltd.
for £ _____

I wish to pay by

Access Visa No. _____ Expiry date _____

Signed _____

Name _____

Address _____

- | | |
|--|-------|
| <input type="checkbox"/> BBC 'B' cassette | £5.95 |
| <input type="checkbox"/> Electron cassette | £5.95 |
| <input type="checkbox"/> BBC 40-track disc | £7.95 |
| <input type="checkbox"/> BBC 80-track disc | £7.95 |

Please tick box

Post to: Mini Office offer, Database Publications,
68 Chester Road, Hazel Grove, Stockport SK7 5NY.

THE ALLIGATA WILL ALWAYS GET YOU

Another set of amazing specials from the software house with the reputation for fast machine code action, high resolution graphics and unbeatable quality. Games to keep you enthralled. Games to get hooked on, but never bored, because once you've started you'll keep coming back for more.

At only **£7.95**
(Disk £11.95) you should bite our arm off

HELP

He'll bite chunks out of your BBC Model B.



Son of Blogger
An enthralling sequel to the famous Blogger as you follow the antics of Slippery Sid through one continuously scrolling adventure, challenging death in his search for the golden keys.



DOUBLE ADVENTURE
XANADU Cottage
EBONY Tower
A treasure trail adventure to places you'd never dreamt of. An unexplored journey to lands unknown, where the fiery dragon lies in wait of the final bloody encounter. Two adventures giving hours of absorbing enjoyment for the bargain price of one.



Tarzan
A multi-screen spectacular featuring the Lord of the Jungle in his relentless fight through 4 vicious levels of ferocious blood thirsty beasts and river obstacles in order to save his darling Jane from her awesome fate. Sloppy stuff but well worth fighting for the climax.



5 BEST SELLERS
£9.95
£13.95
CHARTBUSTER
Chartbuster
Five outstanding games in one package - Blogger, Neanderthal Man, Web Runner, Monaco and Eagle Empire. Hits you may have seen or heard about but could never afford, now available in this 1984 bonanza.

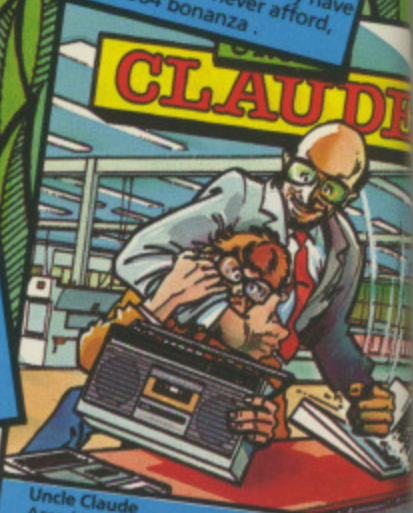

UNCLE CLAUDE
Uncle Claude
Arcade excitement - 11 compelling levels of fast moving action; a nasty evil capitalist in Uncle Claude and poor innocent Micky vainly trying to save his friends jobs - all creates a game that's a must for any games enthusiast.

- Tarzan Chartbuster Uncle Claude
 Son of Blogger Xanadu Cottage/Ebony Tower

Please indicate programs required and whether tape T or disk D

I enclose a cheque/PO* for £ _____

Charge my Access _____

Card No. _____

Name _____

Signature _____

Address _____

Alligata Software Ltd
1 Orange Street, Sheffield S1 4DW
Tel: (0742) 755796



*Payable to Alligata Software †Allow 75p for post and packaging
Despatch is normally made on receipt of order and should reach you within 7 days

MUSIC Tutor (Garland) is a menu-driven musical composition program meant to be used in conjunction with a teacher or a book about notation.

You can input up to 75 notes either by code, or by using two rows of the BBC keyboard configured as a piano.

With the second method notation appears on the screen as you compose. This is an important and useful feature though a keyboard overlay, rather than a diagram in the manual, would have been an obvious enhancement.

You can listen to your composition – at one of 10 different tempi – edit it, and save it.

The documentation is comprehensive and clearly set out. But there begins the rub. Notes, we're told in the manual, are "correctly located on the clef" (not the *stave*). A slip of the pen? No, the mistake occurs several times, in different forms.

It would appear that the author is no musical theorist – a suspicion confirmed by the program itself.

In input mode the treble clef doesn't encircle the G line of the stave. Not a cosmetic matter – the position of clefs should be part of basic music tutoring.

You then find that the only accidental available is a sharp, though there are good musical grounds for using flats and naturals too.

Indeed, one of the reasons



why the screen notation looks unusual is that it becomes so sharp-infested.

Worse, however, is that the sharps appear, incorrectly, above their notes rather than next to them. Formatting accidentals in music programs is difficult, but you can't just sidestep the problem by misplacing the signs.

There is more. The pitch of each note is changed individually, preventing a beginner getting a "feel" for key signatures. You can't experiment with harmonies. There's no choice of clef. Dotted notes can't be input in keyboard mode. You can't input bar lines at all.

The editing procedure is a positive discouragement. If you make a mistake at input you have to go into edit mode. Here, the notes of your tune are presented, in order, one by one – with a cleared screen, so you can't see the notation and edit it at the same time.

Unless you've written your

tune down by hand – there's no facility for hard copy – it's virtually impossible to remember which note to change.

And if you switch back to look at the notation you have to start editing again from scratch. Such a user-hostile approach is calculated to create the impression that learning music is a chore.

To cap it all there are two rather serious bugs in the program – I assume they're bugs, not further musical errors. A semiquaver rest is displayed as a semiquaver note and "top"

G sharp is drawn with a ledger-line.

The general design parameters of the program are perfectly adequate for beginners. The range of notes, for example, is just over one and a half octaves, and duration is between a whole note and a one-sixteenth.

Within such limits many teachers are waiting for an easy-to-use, musically accurate and creative learning aid. Music Tutor could have fitted the bill. As it stands, it does not.

Gabriel Jacobs

Dig for your life

IN **Digger** (Visions) your only defence against nasties which invade your allotment is a pump. This prods the nasty, causing it to expand until it explodes.

If you only pump it a couple of times then the invader is only temporarily stunned, making a pip noise on recovering.

A more subtle way of killing one is to mine underneath one of several rocks on each screen, dash out of the way, and pray that it falls on a passing nasty.

The screen is neatly presented with score and number of lives

left. Below is the allotment viewed from the side so that you can see the soil underground.

The occasional fruit or vegetable appears, yielding a bonus if taken.

Animation is smooth, although with many nasties on the screen it can get a little jerky. The detail of the characters is excellent.

A fun game that would be appreciated by the keyboard basher who thinks there's more to life than Space Invaders.

Philip Tudor



THE preamble of **Multibase** claims that it allows you to create and manipulate a variety of multi-record files to suit your own needs, and is ideal for keeping all your personal records.

All of which sounds very promising.

The main program loads after a short title page and displays a menu giving nine options, to create, display, search, alter, save, load or add to a file, to delete a record or to dump a file.

Promise unfulfilled

These options often form the heart of a database but **Multibase** from G. Soft (Micro Software) offers nothing more, and has some serious omissions.

For a start there is no star command facility. One of the

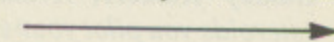

From Page 103

most serious drawbacks is the lack of a sort facility. Advanced features such as calculations are not supported at all.

Just to make matters worse there are some trivial but nevertheless annoying faults and bugs. One of the more serious is that you cannot specify the name under which you save the data.

This may seem unimportant until you realise that you have to specify the name when you come to load the file back in!

Adding to a file is cumbersome in that it allows you to type in a string of any length, then checks the length. Deleting a file is very unprofessional since it doesn't tell you what you're about to delete.

Hasn't the author ever heard of the term "user-friendliness"?

Other little niggling faults include the untidy prompts, non-masking of lower case and the very uninformative instruction booklet.

Shingo Sugiura



Search and destroy

YOUR mission, if you accept the challenge in *Eagles Wing* (Software Invasion) is to fly your aircraft along the river until you reach and, hopefully, destroy the enemies' missile silos and their command centres.

There are plenty of defences along the river, and you need to

destroy at least some of these to bring on your in-flight refuelling tanker.

The further upstream you get, the more aggressive the enemy and the more interceptor aircraft there are trying to crash into you.

Press the spacebar and away we go, flying upstream, shooting up the various enemy installations whilst clocking up score and damage to ourselves and using fuel.

Provided we don't crash into the canyon walls, run out of fuel, or get destroyed, when we've scored 10,000 our in-flight service station appears.

Throttle right back, avoid shooting it down, and we dock with it, where-upon not only does it refuel and rearm us, but by some miracle also repairs all our damage. Then on with the mission...

There is only one major criticism - the quality of the sideways scrolling. There is a continuous flicker on the left of the screen as the next line to appear on the right (yes, I do

mean right!) is put into screen memory.

The scrolling itself is so poor that to anyone stood watching it appears that the screen is out of focus. Compared with other sideways (and, nowadays, even diagonal) scrolling, this is very primitive.

Fortunately, this isn't too noticeable to the person actually playing who is watching only a small portion of the screen.

Probably the only other feature worthy of mention is the "brown" used for the canyon walls, and even this has been seen in other programs from this publisher.

At least in this game I stand a fair chance of keeping my name in the "top 10" table - my reflexes are so much slower than my son's that in most "reaction" games the lowest score he has in the table is usually well above anything I can achieve.

Despite its shortcomings, I think I will see my son on "Operation Eagle's Wing" at regular intervals in the future.

Now, which key was it for

QUICK RUNS *A first look at some of the latest releases*

Fun With Numbers: An educational suite of four programs aimed at the 4 to 7 year age group. Colourful graphics are used to test a child's ability to count, add and subtract. A final arcade style shooting game tests all three and includes a Hall of Fame. (Golem).

★★★

Star Seeker and Solar System: An educational package complete with 28 page manual, *Star Seeker* plots the most prominent stars from any position on earth. *Solar System* provides a similar service for the planets and Halley's Comet. Both have the facility to print to an Epson. (Mirrorsoft)

★★★

Hi Bouncer: Keep up with Mr Bounce as he leaps around town helping his friends. In this arcade game with four different screens and eight levels of difficulty you'll meet Mr Tall, Mr Lazy, Mr Bump, Mr Snow and many other favourites, but your tactics on each screen are different. (Mirrorsoft)

★★★

Galaxy Raiders: Avoiding storms of asteroids you pilot your starship into 3D

space engaging the Arian fleet which is intent on your destruction. You must also defend your starbases, essential to your survival, by hyperwarping to selected sectors. Your aim is take the shortest time possible with the minimal amount of refuelling. (Visions)

★★★

Uncle Claude: Sneaking into the electronic warehouse after dark you must prevent the boss, Uncle Claude, from making a profit. He is out to maximise his profits by selling goods at excessive prices, and you have been hired by the union to ship them to the shops quickly, so as to avoid job losses. You must steer clear of the prickly acorns and Claude himself as you endeavour to load a variety of electrical goods onto the conveyor belt. (Alligata)

★★★

Spitfire Command: Pit your skill and daring against the Luftwaffe as they prepare to clear the way for the invasion of Britain. You view the opposing aircraft from your cockpit as they bank and turn, attempting to destroy you before your rapid machine gun fire

blows them to pieces. (Superior)

★★★

Star Striker: Controlling a rocket equipped with lasers you must defend yourself against circling aliens. To add difficulty to the task you must also avoid asteroids and fireballs. Can you dock with two additional stages of your rocket to increase your fire power or are you doomed to lose each stage in a futile attempt? (Superior)

★★★

Starship Discovery: A member of the crew of *Starship Discovery*, your job is to undertake repair work on the outside of the ship. At your disposal is an EVA pod which, under simulated test conditions, you must pilot through eight levels of difficulty. (Alligata)

★★★

Laser Reflex: Left in sole charge of a remote asteroid refuelling base, your only defence against invading drones bent on plundering the fuel supplies is a powerful laser cannon. It is fast, deadly and uses a giant mirror to angle your fire power. (Talent Systems)

shooting up ground installations? Right, away we go again...

Michael Gilbert

Blast the dams

HAVE you ever fancied yourself as Guy Gibson flying your beloved Lancaster equipped with Barnes Wallis's bouncing bomb? Look no further than Alligata's **Dambusters**.

You fly over landscape made up of a single green line... but use your imagination. The aim is to destroy as many dams as you can before enemy fighters get you. The dams are also heavily protected by anti-aircraft guns.

So you must dodge the flak, destroy the fighters, and aim and drop your bomb too.

The bomb sight is the ingenious dual spotlight system. You try to get both beams of light as close together as possible on the surface of the water.

This is a lively and interesting simulation. The game isn't easy to master and the number of keys to be pressed - seven - is rather overwhelming.

The sound isn't all that exciting and there are no bonus screens or real game variations apart from a general speeding up and the appearance of more enemy planes.

An exciting and involving game, but not as addictive as one might expect.

Dave Carlos

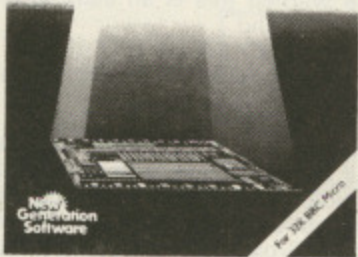

Assembly language unveiled

THE Complete Machine Code Tutor (New Generation Software) is not a machine code tutor at all, but is in fact a very good suite of programs that will teach you how to use, and write in, assembly language.

It takes the total novice from basic principles right up to relatively complex programs, explaining each assembly code instruction, and giving a demonstration program.

Once loaded the clinically clean Mode 7 display screen keeps you well informed of your progress through the lessons. Once each stage is completed it automatically steps on to the next one.

It is fairly easy to get to your

desired program, even out of sequence. This is achieved by using the Return key to step you down the page.

Much of the program is automatic, only requiring a specified key depression to start the next activity. The very neat coloured display makes keying errors minimal, but even so the crash proofing is excellent.

The lessons seem a little out of order but it isn't that confusing, although some of the text does seem a little ambiguous in places and in some instances may require a second read to understand fully the following example.

Each stage of the package - from New Generation Software - has a descriptive text, explaining an instruction code, or a group of codes. It then provides a working program, which makes the theory become fact.

The code of the example programs is single-stepped with the Return key, allowing a constant on screen display of the 6502's registers and flags.

The screen display can be altered from a simple to understand form to a much more comprehensive display, showing the actual addresses that the code is working at.

Another feature is the ability to flip between decimal and hex notation - a great teaching aid in itself.

On the whole this dual market package should be as useful in the school as for the enthusiastic home user. My one main criticism is that there are no self

assessment questions, which would be very beneficial.

Accepting the limited size of the available memory in this package it can be used as a development tool for assembly programs, and as such does not fall into the category of a "useful only once" program.

Garry Marsh



Battling for Boris

BORIS has had his home raided by the underworld creatures who have stolen most of his possessions.

As you can imagine, Boris is quite peeved and sets out to retrieve his valuables. Your task is to guide him through the underworld and fight off the creatures that await him there.

When **Boris in the Underworld** (Superior Software) starts, Boris appears on the left hand side of the screen and a large number of nasties appear. You have to shoot these before the underworld fiery walls engulf you.

Each time you successfully fight off a horde, you will get one of Boris's possessions back.

As the game progresses, it will get harder to kill the creatures, indestructable discs will start flying around the cave and the fiery wall will move in faster.

The graphics are sharp, characters are colourful and well defined and the animation is

Learning by building

NOT exactly history, not quite English, some maths certainly - but a lot of enthusiastic discussion and cooperation. That's **Fletcher's Castle** by Fernleaf Educational Software.

This educational game is aimed at the 8 to 12-year-olds. Simon Fletcher, a Norman knight, has a grant of land on which he has to build a motte and bailey castle.

He can recruit local workers to help his soldiers but they cannot be trusted alone. The object is to divide the workers

and soldiers into groups to complete six tasks and get the castle built in 10 days.

The instructions are clear and well presented, but there are rather a lot of them to remember and children playing this game for the first time needed prompting.

They did not like leaving this game in the middle. It takes at least half an hour to play it right through and they were a bit disappointed when they realised how difficult it was to complete.

Sound is not used - perhaps a

good thing in a busy classroom - but the graphics could be much more detailed and the castle should be drawn faster.

The worksheet provided can be copied for a permanent record.

The object of the program is to encourage language development and logical reasoning. It does this very well and a teacher could also use it as a mathematical aid.

Worth a place in the junior school program library.

Alison Cernyw-Hughes



SATAN'S CHALLENGE

or (Nevil Rides Out) A Black Magic Adventure



Dare you take up the challenge laid down by the most evil and sinister of all beings . . . the devil himself.

If you do you will find yourself alone and at the mercy of the twisted fancies and whims of a cold and calculating mind.

Occult forces are threatening the lives of those near and dear to you. Their only salvation rests in your hands but in accepting the challenge your own existence is put in severe peril.

In taking up the challenge you have to find the TALISMAN and locate a pentagram which then has to be prepared for the final rite. In the mean time dark forces will be opposing you making a difficult task almost impossible.

Do not allow yourself to be lulled into a sense of security for it will be short lived.

Many have gone before only to swell the ranks of the damned.

This is the latest adventure from the stables of Microtest and has been written with the acclaimed features of other adventures in mind eg save facility, quick response, simple but extensive commands, a mixture of logical and fiendish problems to solve.

Be warned this is an easy adventure to get into but devilishly difficult to end.

CASSETTE £7.95 inc VAT

DISC 40 or 80 tk £9.45 inc VAT (add 50p p&p)

DAIRYFILE FOR DAIRY FARMERS

Keep on that economic line between over and under feeding!

Save time recording milk yield and calculating feed amounts!

Quickly decide feeding policy with the 'Monthly Calving Group' Performance Graph!

Print out a recording sheet with cows in numerical order. Print out graphs or tables of individual cows or Monthly Groups showing serving and pregnancy details, illness record, Calving Index, weekly and running total Margin over Concentrate. See at a glance cows due for serving, pregnancy diagnosis and drying off. Keep track of

weekly total feed cost and milk sale price.

All this and more with DAIRYFILE.

Predict cow or Monthly Group total lactation yield. Compare with Standard Lactation Curves. All old data preserved - compare Monthly Groups over the years. Which is the most profitable month?

Find out with DAIRYFILE - for up to 200 lactating cows.

Available on dual 40 tk disc (For dual 40 tk drives only)

Dual or Single 80 tk drives **£69 inc VAT (add 50p p&p)**

Please state on ordering which disc format and printer model.

MICROTEST FONT ROM

This exciting new ROM from Microtest will enable you to get all sorts of new characters and fonts from your BBC Computer. Once you have produced your masterpiece on the screen, all you have to do is use the inbuilt screen-dump utility to produce a hard copy onto paper.

Typing '*HELP FONTS' gives a list of available fonts and the blocks of characters which they replace.

Available fonts are:

- *Accents Accents and miscellaneous.
- *Block Small capitals.
- *Data Like the bottoms of cheques.
- *Greek It's all Greek to me too!
- *Joined Standard capitals with joined up lower case.
- *Maths A mix of until now unobtainable Mathematical symbols.
- *Miscellaneous A few oddities which often are very necessary.
- *Thick Thick text (for MODEs 0&3) to enhance 80 column mode.

*Thin

Thin text (for MODEs 2&5) which makes modes 2 & 5 much more readable or perhaps "READABLE".

*Vertical

For labelling graphs.

*MODE 8

Ten column multicolour, memory-miserly mode.

*S DUMP

A dump facility which will produce a screen dump of any MODE from 0 to 8 (including a text only dump in MODE 7) on an Epson, Star, CTI CP80 or MT80.

The ROM uses absolutely NO user memory and can be used with word processors etc. as well as normal BASIC programs. The DUMP utility will produce positive or negative graphics and will also rotate the picture produced through 90° as well as being able to position the picture anywhere laterally across the sheet of paper.

£17.50 inc VAT (add 50p p&p)

Microtest Starstick ROM & Joystick Package

Now available the Starstick ROM and Joystick. This comes in three forms:

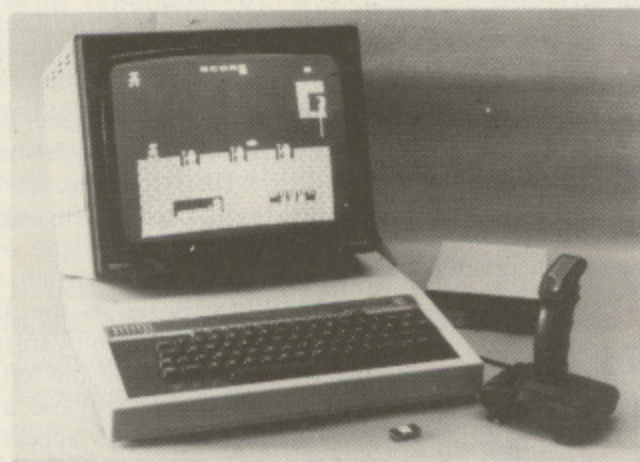

Enables you to use our joysticks on most programs even those that do not offer joystick capability.

(A) The Starstick ROM and Quickshot I Joystick

Price 17.95 + VAT = 19.84

(B) The Starstick ROM and Quickshot II Joystick

Price 19.25 + VAT = 22.14

(C) The Starstick ROM and patch lead, choose your own Spectrum/Atari style joystick

Price 15.25 + VAT = 17.54

Post and Packing £1.00 inc. VAT per item

This enables you to plug the Rapid action self centring joysticks until now only available for the Spectrum/Atari/CBM machines into the user port of the BBC. Model A users please note NO ANALOGUE INTERFACE REQUIRED.

Disc Users Note - pressing BREAK, SHIFT-BREAK or CONTROL BREAK does not modify or destroy the STARSTICK software so Disc Users please feel free to Boot!

The software patch provided in the ROM is interrupt driven and adds the following commands to your computer.

- ★ STICK turn on the STARSTICK ROM
- ★ NSTICK turn off the STARSTICK ROM
- ★ SETSTICK set up joystick to users spec
- ★ SAVE "NAME" 140 160 saves your user-key protocols
- ★ ADVAL emulate standard analogue joysticks
- ★ PAUSE define key to Freeze game
- ★ NPAUSE turn off ability to freeze game
- ★ "NAME" predefined key protocols set up for software houses programs
- ★ HELP KEYS displays currently selected key protocols
- ★ REPEAT enables auto-repeat fire
- ★ NREPEAT disables auto-repeat fire



available from

MICROTEST LTD

18 Normandy Way, Bodmin, Cornwall PL31 1EX

Telephone: 0208 3812

OR ANY GOOD DEALER

Large picture shows BBC Computer System and a Quickshot II Joystick. Small inset just a few of the joysticks that will work with the patch lead. Screenshot by kind permission of SUPERIOR SOFTWARE

All MICROTEST ROMs are fully TUBE® compatible. (TUBE® is a reg. trademark of Acorn Computers).

VISA



From Page 105

suitably entertaining.

Although the sound could have been a little bit more imaginative, the whole thing is generally of very high standard and all the little professional touches such as freeze, sound off/on option and high score table are there.

The only faults on the technical side were the lack of a quit facility and the inability to switch sound off in the middle of a game.

However, it is addictive and will appeal to a lot of arcade game freaks.

Shingo Sugiura

Not too friendly . .

TEXT Editor is attractively packaged in a videocassette style plastic case, but unfortunately the software inside – from G. Soft – is not up to the same standard.

Once the program has loaded, the user is asked to set the page width. If no number is entered this defaults to 80 columns. Setting page width to 60 columns results in the right-hand 20 columns being shaded.

This is merely a visual



indication of the length of the line. Any text entered beyond the end of the line will appear on the line below on the screen, but will appear in its true length when sent to a printer.

It is therefore essential to press Return at the end of each line so that each is assigned a new line number and the printed text has the same format as that displayed.

The line length setting causes havoc with another of the editor's facilities. By pressing f4 at the start of a new page the user's address will be printed at the top of the page.

When using any page width setting other than 80 columns, the address will appear disjointed on the screen and will always be sent to the printer in 80

column format despite the width setting of the bulk of the text.

I experienced some difficulty when attempting to save a page of text to tape merely through a lack of user friendliness. When asked whether I wanted to load data I could get no response from the program when pressing either Y or N.

I had resorted to listing the program before realising that the program was only checking for an upper case reply. This problem occurred throughout the program.

Text can be formatted using the Centre command, which moves any text to the centre of the line, such as for headings, and the Indent command which can be used to indent text at the beginning of a new paragraph.

Indent should not be confused with TAB – which is not implemented – as pressing indent in mid-line will erase the text at the beginning of the line.

Printer control codes can be embedded into the text by enclosing them between square brackets.

If one disregards the ambiguous information referring to the insertion of the user's address, then the accompanying booklet is quite good.

There is also no need to make a note of the function key tasks

as these are displayed in the top few lines of the screen.

Overall the package – which costs £9.95 – is a little rough around the edges. If it was re-written to implement optional double spaced printing, a TAB key, and even a simple search and replace routine, then it would be worth consideration as a text editor for the user who merely wants to send the occasional letter and keep a copy on tape for reference.

Jon Revis

Yoyo ousts the laser

FRAK (Aardvark) falls fairly and squarely into the cute category. How else can you describe a game in which the hero, caveman Trogg, wanders through a ladders and levels type landscape collecting jewels, bulbs and keys?

And then when he encounters the inevitable Scrubbly monster what does he do? Does he blast it with his sabre tooth laser cannon? No, with a deft flick of the wrist he smacks it right between the eyes with his yoyo!

You begin with three Troggs

Turn to Page 110

The Micro User Index of software reviews

3 Deep Space (Postern)	Feb 1984
3D Bomb Alley (Software Invasion)	Jan 1984
Action of the Heart (Garland)	Sep 1983
Aid (Lincoln)	Jan 1984
Alien Destroyers (Program Power)	Aug 1983
Alphabeta (H & H)	Mar 1983
Angle (Chalksoft)	June 1984
Animal/Vegetable/Mineral (Bourne Educational)	Oct 1983
Answer Back (Kosmos)	July 1984
Apollo (Software Invasion)	May 1983
Arcadians (Acornsoft)	Aug 1983
Atlantis (IJK)	Mar 1983
Aviator (Acornsoft)	June 1984
Beebcalc (Gemini)	Sep 1983
Beebsynth (Clares)	Nov 1983
Beta Base (Clare)	Sep 1984
Billiards (H & H)	Mar 1983
Bridge to the East (Ixion)	Mar 1984
Bun Fun (Squirrel)	Aug 1983
Business Games (Acornsoft)	Mar 1984
Canyon (BBC Soft)	Oct 1983
Cashbook (Gemini)	Aug 1983
Castle Assault (MRM)	Sep 1984
Castle of Riddles (Acornsoft)	Jan 1984
Chess (Bug Byte)	Apr 1983
Chess (Acornsoft)	Dec 1983
Chess (Computer Concepts)	Dec 1983
Chickaroo (Screenplay)	May 1984
Circus (Digital Fantasia)	Jan 1984
Colossal Cave (Level 9)	Feb 1984
Commercial Accounts (Gemini)	Jun 1983
Community (Ixion)	Mar 1984
Connect 4 (Database)	Apr 1983
Cosmic Kidnap (Superior Software)	June 1984
Countdown to Doom (Acornsoft)	Jun 1983
County (SM) (Bryants)	Mar 1984
Cylon Attack (A & F Software)	Feb 1984
Datext (Optima)	Jan 1984
Dbasebeeb (Carrera)	June 1984
Delivery (Paeon Systems)	Apr 1984
Devil's Causeway (Kaydee)	Sep 1983

DFS (Amcom)	Sep 1983
DFS (Watford)	Sep 1983
DFS (Amcom)	Oct 1983
Disc Executor (Vision Software)	Jan 1984
Dragon Rider (Salamander)	Oct 1983
Easy Crasher (Salamander)	May 1984
ECFG (Gaelsett)	May 1983
Escape from Moonbase Alpha (Program Power)	Apr 1984
Escape from Orion (Hopesoft)	Nov 1983
Essential French Verbs (Carsondale)	Dec 1983
Eye (Longman)	Aug 1984
Facemaker (Ask)	Jan 1984
Firehawks (Postern)	Dec 1983
Five spheres of Goliath (Kansas)	Sep 1984
Flints Gold (Micrograf)	Aug 1984
Forth (Level 9)	Nov 1983
Fortress (Amcom)	June 1984
Franklin's Tomb (Salamander)	May 1984
Frogger (A & F Software)	Mar 1983
Fruity Freddy (Softspot)	July 1984
Fungames (BBC Soft)	Apr 1983
Fun to Learn (Shard's Software)	May 1984
Galactic Firebird (Kansas)	Nov 1983
German Sentence Practice (Educated Owl)	Dec 1983
Ghouls (Program Power)	May 1984
Grafkey (Clares Soft)	Apr 1983
Great Britain Ltd (Simon Hessel)	Jun 1983
Gunsplode (Software Invasion)	Nov 1983
Heist (Softspot)	Aug 1984
Hide & Seek (Ask)	Jan 1984
Hobbit (Melbourne House)	June 1984
Home/Business Pack (Gemini)	June 1984
Home Finance (BBC Soft)	May 1983
Hopper (Acornsoft)	Sep 1983
Horror Castle (A & F Software)	May 1984

Hunchback (Superior Software)	May 1984
Hyperdrive (IJK)	Mar 1983
Inheritance (Simon Hessel)	Jun 1983
Invaders (IJK)	Mar 1983
Invaders (Software Invasion)	May 1983
Jigsaw (ega beva)	May 1984
Junior Maths Pack (Program Power)	Oct 1983
Key Definer/Char Gen (Gsoft)	Sep 1984
Lemming Syndrome (Dynabyte)	June 1984
Let's Count (Ask)	Jan 1984
Lift off with numbers (Shiva)	Aug 1984
Lines and Angles (4mat)	Aug 1984
Love and Marriage (Acornsoft/Ivanberg Software)	May 1984
Lords of Time (Level 9)	May 1984
Lost in Space (Salamander)	July 1984
Man (Chalksoft)	June 1984
Marklist (Optima Software)	Apr 1984
Mary Rose (Ginn)	Jan 1984
Missile Base (Acornsoft)	Apr 1984
Music (BBC Software)	Apr 1983
Music Editor (System)	Dec 1983
Music Synthesiser (Bug Byte)	Jul 1983
Number Puzzler (Ask)	Jan 1984
Oblivion (Bug-Byte)	Apr 1984
Old Father Time (Bug Byte)	Jan 1984
One Disc Home Office (Dr. Soft)	July 1984
Omega Probe (Optima Software)	May 1984
Package 004 (Software Invasion)	Jun 1983
Paintbox (Oakleaf)	Mar 1984
Painter (A & F Software)	May 1983
Pascal, Sequences, Puncman (Chalksoft)	Nov 1983
Peeko-Computer (Acornsoft)	Feb 1984
Pengo (H Soft)	Feb 1984
Philosopher's Quest (Acornsoft)	Jan 1984
Physics (Program Power)	Dec 1983

Physiological Simulation (Fiveways)	Dec 1983
Pimania (Automata)	Mar 1984
Printer Monitor (Watford)	Mar 1984
Programs I (BBC Soft)	Apr 1983
Reading Music (Childsplay)	June 1984
Rocket Raid (Acornsoft)	Jul 1983
Rubble Trouble (Micropower)	Sep 1984
Screen Dump (DACC)	Mar 1984
Sea Lord (Bug-Byte)	Apr 1984
Shrinking Professor (A & F Software)	Apr 1984
Slick (BP Educational)	Jul 1983
Snapper (Acornsoft)	Dec 1983
Snooker (Acornsoft)	Oct 1983
Snowball (Level 9)	Feb 1984
Space Pirates (Bug Byte)	Mar 1983
Sphinx Adventure (Acornsoft)	Jan 1984
Spooks and Spiders (Software Inv)	Sep 1984
Spreadsheet (Microl)	Nov 1983
Sprite-Gen (DACC)	Dec 1983
Sprites 2 (Simonsoft)	Sep 1984
Spy (System)	Nov 1983
Star Maze II (Kaydee)	Oct 1983
Starship Command (Acornsoft)	Oct 1983
Stock Car (Micropower)	Sep 1984
Superfruit (Simonsoft)	Aug 1984
Supergolf (Squirrel)	Mar 1984
Swoop (Program Power)	Sep 1983
Taxcalc (BBC Soft)	Nov 1983
Tense French (Sulis)	Sep 1984
Tess (H & H)	Apr 1983
The Grange (Jobsoft)	Jan 1984
The Synth (Musicoft)	Aug 1984
Timeman One (Bourne Educational)	Sep 1983
Toolbox (BBC Soft)	Mar 1984
Transistors Revenge (Softspot)	June 1984
Vampire Castle (Micrograf)	Aug 1984
Vortex (Software Invasion)	Sep 1984
Vu-File (Psion)	Nov 1983
White Knight (BBC Soft)	Dec 1983
Wordhang (Bourne Educational)	Oct 1983
Wordwise (Computer Concepts)	Jul 1983
Zany Kong (Solar Soft)	Sep 1983

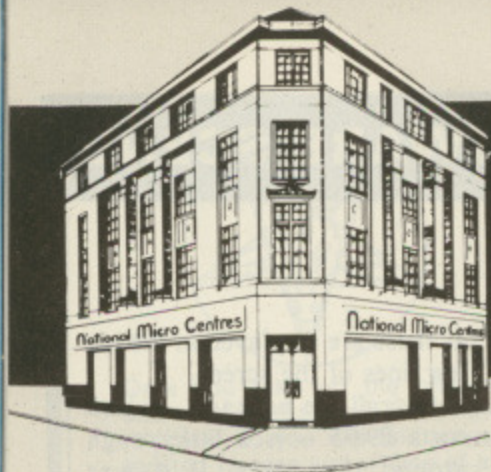

National MicroCentres

We bring you the best of both worlds...

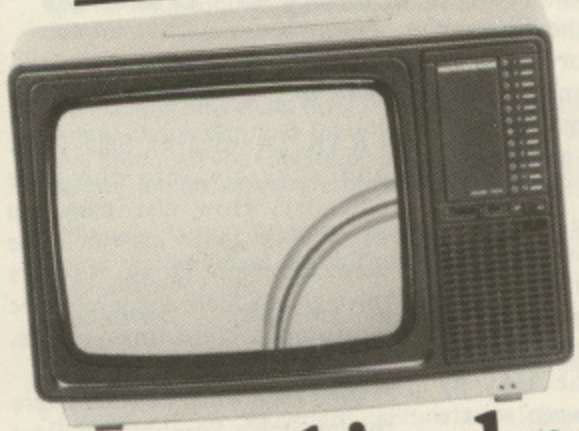

for only
£206.96

...a combined portable TV and RGB colour monitor

Here's an ideal answer to arguments about who should use the home TV set. The superbly engineered 14 inch Nordmende has been specially designed for use both as a monitor and a domestic television. Linked to your BBC Micro it gives the crispest possible reproduction of the BBC's colourful graphics, making it ideal for playing arcade games. And you can also use it as a portable TV giving you maximum mobility. Yet the price is less than for many comparable colour monitors - and you get an RGB connecting lead for your BBC Micro as well.

Other Monitors available include:

Zenith 12" Green Screen	£68.00
Microvitec 14" Colour low-res	£189.00
Microvitec 14" Colour med-res	£285.00
Microvitec 14" Colour hi-res	£419.00

The Monitor you've been waiting for

ONLY £65.00

The Philips V7001 12" green screen high resolution computer monitor.



LOW-COST PRINTERS

We have selected three of the most popular dot matrix printers. All allow you to condense or embolden text, offer high definition characters and allow you to produce clear-cut graphics and charts.

- Brother**
HP5 (30cps) **£148.62**
- Epson**
RX80 (100 cps) **£236.52**
RX80FT (incl. friction feed) **£273.91**

For superb correspondence-quality printing you really need a daisywheel printer. Our

choice, one of our top sellers, can also be used as a superior standalone electronic typewriter.

- Silver Reed EX43**
With special BBC interface **£342.83**
Without BBC interface **£249.48**

Speed your games with a joystick

Sureshot: A really high quality joystick for the BBC Micro.
★ Self centering action.
★ Two fire buttons.
★ Rugged construction
£16.50

At last! Now available for the Acom Z80 Second Processor.

Wordstar Professional

The last word in word processing systems. Package includes:

- Wordstar
- MailMerge
- Spellstar
- Starindex

Only £346.00

We offer the very latest in computer data recorders



Only £26.00
Including Mains Supply Unit

The Morwood Slimline Computer Datacorder, designed specifically with the BBC Computer in mind. As well as offering all the facilities for computer programs and Data loading and Saving, it will also blend in with the colours and design of your BBC Micro.

Wide DISC

We only sell that are ca interference

AMS 3" d
AMS-3(S)
AMS-3(T) 2

- Cumana**
- CSX 100 si
- CSX 200 si
- CSX 400 si
- CS 100E si
- CS 200E si
- CS 200E si
- CS 400E si
- CD 200 du
- CD 400 du
- CD 800 du
- CD 400S 4
- switchab
- CD 800S 4
- switchab

New LOW

- Pace slim**
- PSD1 100
- PSD2 200
- PSD3 400
- track, sw
- PSD4 400
- (80 tra
- PSD5 200
- switchab
- PDD2 400
- (40 tra
- PDD3 800
- track, sw
- PDD4 dou
- track) ..
- PDD5 dou
- track) ..

Each drive blank disc II - the enables yo programs

Se de

Casser

- Acomsof
- Collectors
- Database
- Desk Diary
- Forecast
- Membersh
- Personal M
- Manage
- View Print
- BBC Sof**
- Home Fin
- Record Ke
- Diamond**
- Business A
- Flexifile
- Home Acc
- Gemini**
- Cashbook

All p by

From Page 107

and a time limit of two minutes per Trogg in which to yoyo as many monsters as possible while collecting jewels for bonus points.

Should you collect all of the keys on one landscape then you receive a time bonus and are moved on.

Your task is hindered by a constant hail of daggers falling from above and balloons rising from below. Should either of these items touch Trogg he cries "Frak" – a caveman derivation of "Oh bother" – and promptly dies.

As you become a crack shot with the old yoyo you can amass further bonus points by hitting the daggers and balloons.

The graphics are superb. Aardvark has used the Mode 1 screen and created large, highly detailed, cartoon style characters.

Unfortunately the size and complexity of the characters is probably responsible for one of the program's few failings. When it was called upon to move Trogg, a dagger and a balloon, the speed and fluidity of the animation suffered visibly.

Another irritation, probably less excusable, is the standard of

the collision detection routine used.

Several times I outmanoeuvred a falling dagger by a good 3mm yet Trogg still yelled out "Frak" and died on me.

Despite these minor drawbacks, Frak is a superb game that will take you hours to master.

Jon Revis

Now don't the purple

TAKE command of the Roman Empire in 395 AD, and by raising and moving troops – and seeing that funds are available in the correct place to pay and maintain them – prevent the destruction of your Empire by the surrounding tribes and armies.

The Fall of Rome (ASP Software) lasts 12 turns, each representing five years.

You find you need paper and pencil, because the printed map supplied, while giving the names of the provinces within the Empire, provides only the names of the surrounding tribes and not the names of their countries which you'll need. You should list these as they are displayed

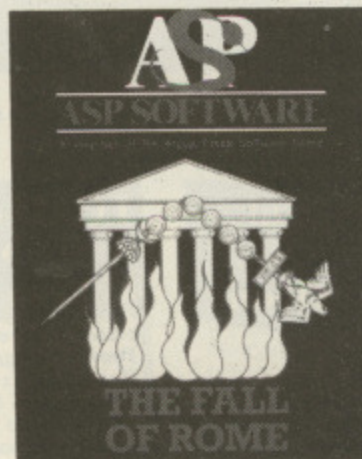

on the screen.

The author of this ASP Software game has done a good job of simulating history, because, while the Eastern part of the Empire can be held (and even expanded) fairly easily, it is almost impossible not to lose a fair number of the Western provinces early in the game, even on level 1.

But don't despair, you can retake them later.

Two points on which the rules make no comment. If you have insufficient funds in a province to maintain the legions present at the start of the turn, some troops will desert.

In the unlikely event that you happen to accumulate more than 255 units of cash (including the start-of-turn income) in any one

province, the taxman will immediately collect 256 from you – due to the fact that all data (except the date) is held as a series of one-byte numbers.

This method of holding the data has one – I suspect unintended – benefit. When you have completed your 12 turns and the game ends, typing RUN does not reset anything except the date, so you can continue from where you left off!

Fancy another 60 years as Emperor?

The only real complaint I have is that there is no provision to save a position and continue later from that point. This facility should be considered a must in any game such as this likely to last over an hour. Don't start a game while having your bed-time cuppa, which is what I did the first time I played it.

The various colour combinations in this program worked fine on my monitor, but on the various TV sets I used the red-on-green maps and the red-on-blue and blue-on-red of much of the text gave a blurred, out-of-focus effect.

Despite the moans – which are really only about frills – the Fall of Rome is as good as any other game of its type, and better than most. **Michael Gilbert**

Keeping tabs on the cash flow

CASH Book Accounting and Final Accounts by Gemini make up a package suitable for use in a cash-based business, replacing the conventional manual cash book.

Using the first program details of all amounts spent and received – both cash and bank transactions – are typed in and the program will produce a trial balance at any time.

The Final Accounts program produces a complete trading and profit and loss account and balance sheet. The programs do not attempt to maintain debtors' or creditors' ledgers.

The programs cost £59.95 each, although they are cheaper if bought as one of Gemini's combination packs.

Cash Book Accounting is generally well-designed and easy to use.

The only time that much technical accounting knowledge is needed in this program is when the journal option is used to make adjustments to the accounts.

As adjustments can often be left until the end of accounting periods, a user can get on with recording the day-to-day cash and bank transactions, leaving the adjustments for an accountant to deal with later.

Ensuring that data entered is accurate and complete is a very important aspect of all computerised accounting systems. This program uses the common method of batch control to minimise the chance of errors getting through.

Gemini state that this program provides a full audit trail, on the assumption that the user always prints out batch sum-

maries. However, even if this were done I think that using the audit trail would be very difficult.

Each account, including those for cash and bank, records only the current balance and no detail is kept on file of the transactions which have resulted in that balance.

The batch detail printouts would, of course, show invoice details and so on and would help.

However, over the course of a year there are likely to be many such printouts each containing many transactions, and each would have to be examined to see if it contained anything relevant to the account in question.

In the case of a busy account made up from many transactions, this would be a long process.

A solution to the problem would be if after each set of updating runs a printout were produced which would show for each account, the brought forward balance, details of all amounts updated in those runs and the resulting carried forward balance.

This printout would show the transactions summarised by account which would make checking much easier.

With the Final Accounts program the user can ask at any time for a balance sheet and profit and loss account along with comparative figures.

The layouts of the balance sheet and profit and loss account are quite adequate for small businesses and these documents can give an easily obtained picture of how a business is doing. **Ken Garrett**

You're never too young to play a Magical Adventure on the BBC Micro or Electron!



Based on the style of the classic computer adventures – but written so that even small children can learn to find their way around, encouraged by colourful graphics and exciting sound effects.

The pack contains a 48-page full colour storybook

PLUS

a full length multi-location adventure on cassette for only

£8.95! post free

Read the book
– then play
the game!



Please send me the complete Magic Sword pack containing storybook and cassette to:

Name _____

Address _____

I enclose my cheque for £8.95 payable to Database Publications

Or debit my Access/Visa card:

No. _____

Signed _____

SEND TO: Adventure offer, Europa House, 68 Chester Road, Hazel Grove, Stockport SK7 5NY

**BASIC
TOOLKIT
ROM**

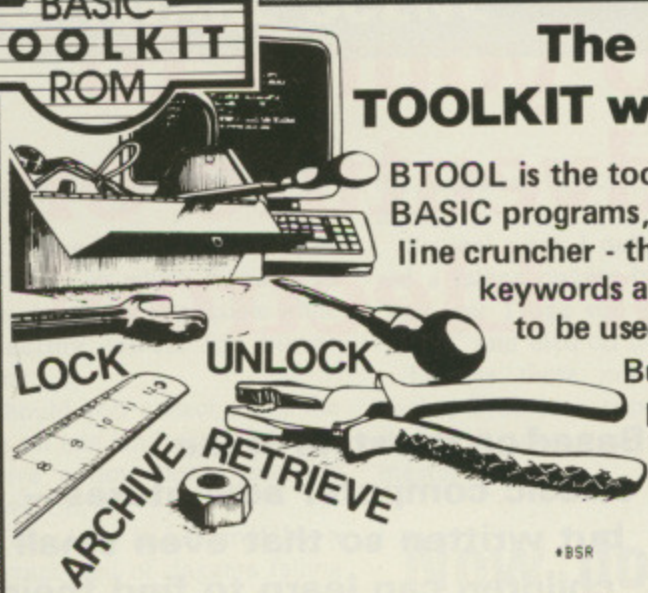

**The
TOOLKIT with CRUNCH**

BTOOL is the toolkit to assist in writing your BASIC programs, because it contains its own line cruncher - thus enabling BASIC keywords and part keywords to be used in *BFIND and *BSR.

But that's not all

Now you can add the following commands to your series 1 Operating System.

- | | | | |
|----------|--|-----------|--|
| *BLIST | Produces a "prettyprint" listing, by splitting up multistatement lines. | *BEQUIV | Allows passing of array names to PROCedures and FuNctions. |
| *BFIND | Finds all occurrences of a string within the given range.
>*BFIND C_100PROC FLUGH
200PROC_DELAY(2) | *BOVERLAY | Allows simple overlaying of program sections.
Plus..... |
| *BREPORT | Indicates the exact position within a line at which a BASIC program fails. | *BMERGE | *BMEND |
| | | *BSHIFT | *BMOVE |
| | | *BLIM | *BVERIFY |
| | | *LOCK | *BPACK |
| | | | *BCRC |
| | | | *BMEM |
| | | | *UNLOCK |
| | | | *ARCHIVE |
| | | | *RETRIEVE |

..... together with *HELP and password protection (requires a password to be entered on power up).

Note: password (if required) may include up to ten alpha numeric characters.

THE BTOOL ROM COMPLETE WITH MANUAL ... £22



BTOOL reaches the parts of BASIC that others cannot reach!
Further details available from DATAWARE



SPELLWISE

The spelin cheka forr the BBC mikro and Werdwyse. SPELLWISE is a machine code spelling checker with a 6000 word dictionary (3000 on tape) which can be expanded to include your own specialist vocabulary.
Tape Version £12 Disc Version £18

LANGUAGEWISE

LANGUAGEWISE allows you to prepare and print foreign text on your BBC Micro using WORDWISE and an EPSON FX80 printer. Most European languages at your fingertips for only £18 (disc only).

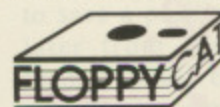

FLOPPYCAT:-DATAWARE CATALOGUE ON A REUSABLE 40 TRACK SINGLE DENSITY 5 1/4 INCH DISC WITH A 5 YEAR MANUFACTURER'S GUARANTEE. 2 GUINEAS (£2.10)
All prices quoted include postage.

DATAWARE

FREEPOST SWINDON SN3 4BR

Copter Capers



S

And
ple
the
ene
all t

AN
FR
BBC 3
Chuc
Haun

TANDON SLIMLINE SINGLE DRIVE UNITS

	ex VAT	inc VAT
40 track 100K	£100.00	£115.00
40 track 100K low power model	£120.00	£138.00
40 track 200K	£135.00	£155.25
40 track 200K switchable to read 80 track	£145.00	£166.75
80 track 400K	£145.00	£166.75
40/80 switchable 400K	£145.00	£166.75

FOR DUAL DRIVES THE PRICE IS DOUBLE THE SINGLE DRIVE PRICE

- * Other drives available - call us for details.
- * All dual drives can be powered by the BBC Micro.
- * Integral power supply is £30.00 inc VAT.
- * The VAT inclusive price gives you a slimline metal cased drive/drives with all data and power cables, user guide and utility disc.
- * Full 12 months guarantee.

Please add £8.00 for carriage by Securicor.
Allow 3 days for delivery.

ROM/RAM Sideways Extension by UDM

16K sideways RAM, write protectable. Selectable 2732, 2764, 27128 Eproms. No flying leads, no soldering - just plug in and go! Fits in with DDFS boards. 16 on board sockets. Turn pin sockets (does not damage existing sockets). Avoids overheating problems.
£47.00 inc VAT and p&p

SALE BARGAINS

100K Drives at £100.00 inc VAT

200K Drives at £130.00 in VAT

Add £3.00 for P&P

Please enquire for other bargains.



CD

Dealer enquiries invited

CARSON DEVELOPMENTS (MU)
84 Highfield Road, Romford, Essex, RM5 3RU
Telephone: 0708 27043



SINGLE/DOUBLE DENSITY FILING SYSTEM BY UDM

- * Acorn compatible - runs BASIC, VIEW, WORDWISE, BCPL
- * Compatible with 2nd processors, Teletext, Oslow 7F
- * Automatic switching between 40 and 80 track mode
- * Automatic switching between single and double density
- * Disc formatter in ROM
- * Complete with manual



£100 inc VAT and p&p for D.F.S.

DISKETTES (per box of ten) inc VAT + p&p

	Wabash	Datalife
40 tk ss sd	£14.50	-
40 tk ss dd	-	£18.00
40 tk ds dd	£19.00	£24.00
80 tk ds dd	£24.25	£29.35

EPROMS ex VAT inc VAT

2764	£6.10	£7.02
27128	£19.00	£21.85

Please add £1.00 p&p

DRIVE CASES

	ex VAT	inc VAT
Slimline	£12.00	£13.80
Full height	£15.00	£17.25

Please add £2.00 p&p

25 single sided double density diskettes in a 50 capacity storage box £34.50 inc VAT p&p.

25 double sided double density diskettes in a 50 capacity storage box £48.50 inc VAT p&p.

Empty storage box at £11.00 inc.

BBC Model B

£380 Inc. VAT

Monitors and Printers also in stock.

The Life Savers!

Save Your Buddies - Play Copter Capers!

Another mindbender from A'n'F - Copter Capers. A new game that's got plenty of capers instore for you! You've got to rescue your buddies from the Pacific Ocean but you'll have a few problems like enemy copters, submarines and balloons - **£6.90** all trying to stop you.

ANOTHER RIVETING GAME FROM A 'n' F SOFTWARE

BBC 32K - Other games available:
Chuckie Egg - £7.90, Cylon Attack - £7.90,
Haunted Abbey - £6.90, Snarl-Up - £7.90.



A&F Software, Unit 8,
Canal Side Industrial Estate,
Woodbine Street East, Rochdale OL16 5LB
Telephone: Rochdale 341111

PROCEDURES

PROCball	Prints the balloon moving left to right in rocking motion.
PROCbal2	Prints the balloon moving right to left in rocking motion.
PROCstr1	Prints the string when balloon is rocking left to right
PROCstr2	Prints the string when balloon is rocking right to left.
PROCmap	Draws course in specified colour.
PROCbcheck	Checks to see if the balloon will hit the sides of the course during the rocking motion.
PROCmovecheck1	Checks to see if balloon will hit the sides of the course when moved from the keyboard while rocking left to right.
PROCmovecheck2	Checks to see if the balloon will hit the sides of the course when moved from the keyboard while rocking right to left.
PROCbang1	Causes balloon to pop when called from PROCmovecheck1.
PROCbang2	Causes balloon to pop when called from PROCmovecheck2.
PROCbbang	Causes balloon to pop when called from PROCbcheck.
PROCgoal	Plays "Congratulations" and works out the bonus scored.
PROCface1	Prints Face1 at top centre and bottom right of course.
PROCface2	Prints Face2 at top left of course.
PROCblow1	Prints breath from mouth of Face2 and causes balloon to be blown away.
PROClives	Records number of lives.
PROCmover1	Moves balloon up, down, left and right when balloon is rocking left to right.
PROCmover2	Moves balloon up, down, left and right when balloon is rocking right to left.
PROCdel	Speeds up movement of balloon as the level increases.
PROCstart	Sets up the starting position of the balloon and prints the initial parameters on the screen.
PROCinst	Prints instructions and sets up the level of play.
PROCend	Prints final score and Hi-score table.
PROCblowcheck1	These procedures check to see if the balloon is blown by Face1.
PROCblowcheck1plus	
PROCblowcheck2	These procedures check to see if the balloon is blown by Face2.
PROCblowcheck2plus	
PROCfanfare	Plays "Blow the man down" when a Hi-score has been achieved.

VARIABLES

HI1%	Hi-score, level 1.
HI2%	Hi-score, level 2.
HI3%	Hi-score, level 3.
HI4%	Hi-score, level 4.
HI5%	Hi-score, progressive level.
S%	Your score.
BON%	Bonus achieved when a goal is scored.
LIV%	Number of lives.
LEV%	Level in play.

Keys

A moves the balloon up.
 Z moves it down.
 ← moves it left.
 → moves it right.

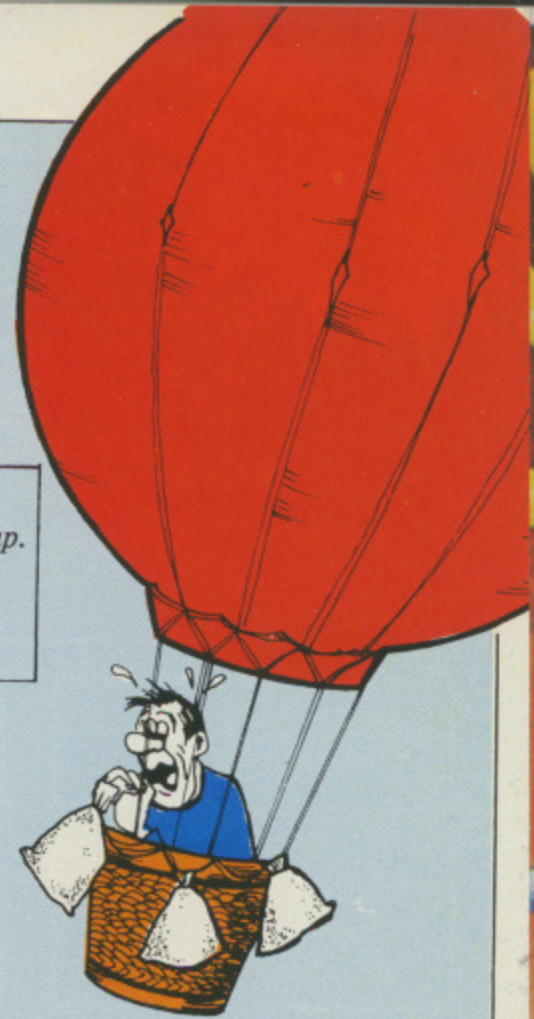

A	Local variables used in PROCmap to read data and set up the course.
B	
C	
D	
E	
XA%	X coordinate of balloon when it pops on side of course.
XB%	Y coordinate of balloon when it pops on side of course.
XF1%,YF1%	X and Y coordinates of Face1.
XF2%,YF2%	X and Y coordinates of Face2.
A1%,B1%	X and Y coordinates of breath from Face1.
A2%,B2%	X and Y coordinates of breath from Face2.
P,Q	Local variables used in PROCblowcheck1, PROCblowcheck2, PROCblowcheck1plus, PROCblowcheck2plus to generate random variables to determine if Face1 and Face2 blow the balloon.
J%,K%	X and Y coordinates of the balloon in PROCblowcheck1, PROCblowcheck2, PROCblowcheck1plus, PROCblowcheck2 plus. This is transferred to PROCblow1 and PROCblow2 if the balloon is blown.
F,G	Local variables used in various time delay FOR ... NEXT loops.
M%	Level chosen. If progressive play is chosen then M%=5, otherwise M%=LEV%.
X%	X coordinate of balloon.
Y%	Y coordinate of balloon.
B%	Relative X coordinate of balloon during rocking action.
C%	Variable used in the main loop to determine the direction of movement of the balloon's rocking action.
Z%	Number of times the balloon has rocked since the last keyboard input.
I	Ascii value of input.
W%	X coordinate of balloon during blowing.

Full listing starts on Page 181

SPECIAL OFFER!
Order both directly from us and deduct £1 from each.

TWO SENSATIONAL NEW RELEASES FROM SUPERIOR SOFTWARE

BBC MICRO

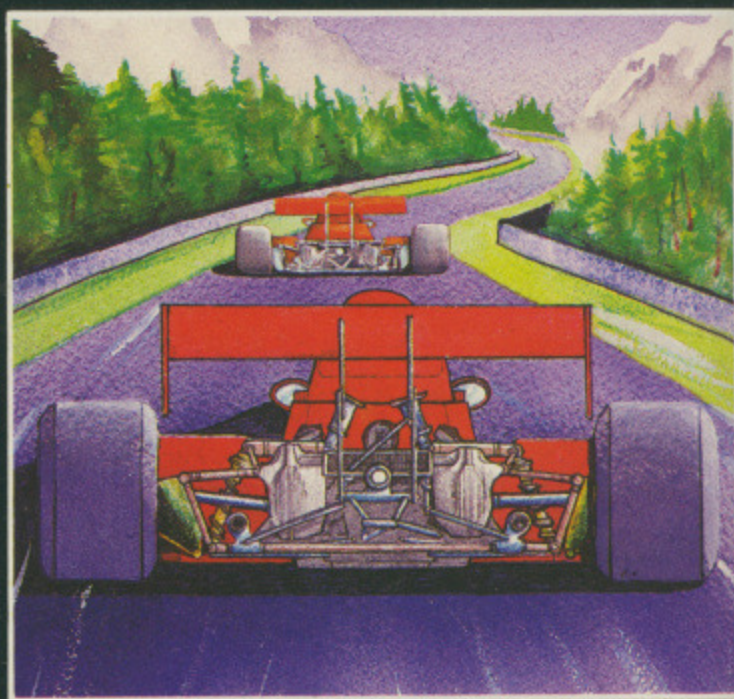

OVERDRIVE (32K)

£7.95

A highly-addictive multi-stage 3D race game. You steer your car left and right, accelerate and decelerate as the opposing cars weave about the road. There are five different stages including night, snow, desert, and riverside scenes. To qualify for the next stage, you must finish in the top twelve. Incredible graphics give the impression that you really are taking part in the race. Highly recommended, and destined to become another top-seller for Superior Software.

●●●NEW RELEASE●●●

OUR PROGRAMS ARE NOW AVAILABLE FROM OVER 1000 OUTLETS THROUGHOUT THE UK AND OVERSEAS. SEE YOUR LOCAL DEALER!

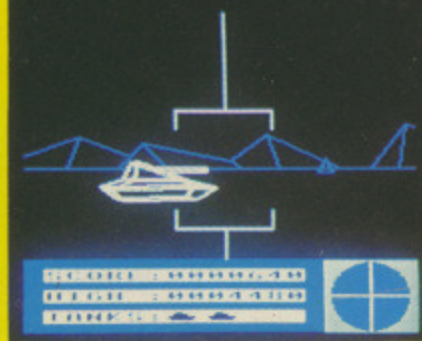

BATTLE TANK (32K)

£7.95

An excellent game, made possible on the BBC computer only by the unique use of a dual-screen display and specially written plotting routines. You are a tank gunner looking out onto a mountain plateau. You see the distant mountains and the pyramid obstacles – and also the enemy tank. Your task is to shoot it before it shoots you. A scanner is displayed in the bottom right-hand corner of the screen. This displays the position of the enemy tank relative to you. You can then turn to get the tank in view. The next stage is to position the tank in the rectangular viewfinder by fine adjustments of your controls.

(KEYBOARD or JOYSTICKS)

●●●NEW RELEASE●●●

WE PAY UP TO 20% ROYALTIES FOR HIGH QUALITY BBC MICRO AND ELECTRON PROGRAMS



SUPERIOR SOFTWARE LTD.

Dept. BMU5, Regent House,
Skinner Lane, Leeds 7
Tel: 0532 459453

OUR GUARANTEE

- (1) All our software is available before we advertise.
- (2) All our software is despatched within 48 hours by first-class post.
- (3) In the unlikely event that any of our software fails to load, return your cassette to us and we will immediately send a replacement.

BBC
VIDEO

NIGHTMARE MAZE



NEW RELEASE
 For BBC 32K O.S. 1.2
 & The Electron
**MULTI-SCREEN
 ARCADE GAME**
£5.70 Fully inclusive



WORM
 SOFTWARE

17 Cross Coates Road, Grimsby,
 South Humberside.
 Tel: 0472 44304.



20,000K Winchester Disc for your BBC Micro

INTEC MAKES THE BBC REALLY COMPETE WITH
SYSTEMS COSTING 2X AS MUCH!

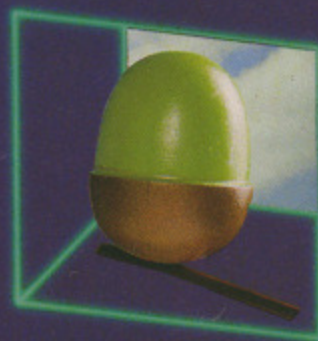

- ▶ Supports BBC and Acorn DFS.
- ▶ Full file handling and diagnostic software utilities.
- ▶ Data capacity from 5 Mb upwards.
- ▶ High speed accessing.
- ▶ UK manufactured.

The INTEC 505 gives all these benefits PLUS the removable hard disc cartridge providing a compact, secure and usable back-up or cartridge per application approach. Why pay more for less?

For full details on the INTEC range of hard discs for the BBC Micro, complete and post the tear-off slip or phone INTEC now - 01-761 5999.

INTEC
41A-45 Knights Hill
West Norwood, London SE27 0HS
Telex 8813271 GECOMS G

INTERFACE TECHNOLOGY

INTEC

Please Cut Out and Return
The INTEC Hard Disc Range
5-20 Mb Winchester and the fixed and removable 505.

NAME _____
ADDRESS _____
BRO _____

6809 2nd processor*Cambridge Microprocessor Systems*

TWO types of second processor are available for the BBC Micro. The first looks and feels like the computer you are used to. You can program it in Basic or any other language you have and all the commands will be the same.

You will, however, get more room to program in and the programs will work faster as the second processor does the thinking while your original computer handles the input and output.

The Acorn 6502 second processor is the only one of this type.

The second kind converts your BBC Micro into a totally different computer able to run different operating systems, languages and machine code.

All other second processors fall into this category. Among the pack the 6809 second processor from Cambridge Microprocessor Systems must surely stand out as one of the best.

In fact when it came into the office for review the editor and I had a fight to see who was going to review it. I'm glad to say I won.

The advantage of using a second processor is that you already have the expensive components of a computer system – the disc drives, keyboard and display – so you can just glue on another engine and away you go.

The 6809 second processor is built on a 4in x 8in board and plugs into the Tube connector on the underside of the computer.

It consists of a 6809 microprocessor running at 1MHz, 64k of dynamic memory, a 4k eeprom operating system and a bus expansion socket. It also contains two discs and documentation.

On the software side there is a monitor, disc operating system and a 6809 editor and assembler.

To get the processor up and running you simply place in the link disc and press Shift and Break. The screen then comes up with a menu which allows you to format a disc for the new processor, enter a 6809 machine code monitor or run the disc operating system.

As you will see, the system needs discs formatted differently from the normal BBC format so there is no chance of getting the programs on them confused.

The machine code monitor allows you to do all the usual things machine code monitors normally do. You can

examine and change memory locations, load and dump blocks of memory as well as executing a program. This in itself is all very well, but is not spectacular.

When you enter the disc operating system however things begin to happen. This is called Flex and has a prompt of three plus signs (+++).

At this point I must declare an interest in that Flex was the first disc operating system I ever used on a micro. It was way back in the dark ages of 1977 and ran on a South West Technical Products 6800 system.

At the time I thought it was nothing particularly special as it did all I wanted it to do in a simple straightforward manner. It was only later when I was exposed to other systems like CP/M and the BBC disc filing system that I appreciated how good Flex really was.

The major part of the operating system is stored on disc and when you type a command it will execute a file with that name (plus an extension of CMD).

This technique is known as overlaying and means that the operating system takes up a minimum amount of memory. Also command names can be changed simply by changing the file name.

In addition you can write new commands, save them on a file and include them on the system disc. They become as much a part of the disc operating system as any other command.

One command I miss on most other systems is the COPYNEW command which will copy only files that are not already on the destination disc.

Flex has been running for a number of different machines for many years and so there is quite a bit of software

The fight for the 6809 was one I'm glad I won!

available to use with it. This means you can now run languages that have not yet been implemented on the BBC Micro.

Among those available – at extra cost of course – are Cobol (for those of you with commercial interests), Pascal (for the real structured programming nuts) and PL9 (for system developers).

For machine code freaks there is a bunch of utilities as well as cross assemblers which cover most of the available microprocessors.

One that caught my eye in the literature was the 6502 simulator and translator. This allows you to convert 6502 source code into 6809 source code or simulate the running of it. Also, if you really insist, you can get an extended Basic.

It should be noted that these languages do not come free with the second processor and have to be bought separately.

For those of you not familiar with the 6809 microprocessor, it is generally known as the programmer's processor.

The instruction set is very orthogonal, which is jargon for sensible and consistent. It has two 16 bit index registers, two 8 bit accumulators and two 16 bit stack pointers.

The designers, Motorola, say it is a bridge between the 8 bit and 16 bit world – although if Sinclair were selling it he would call it a 16 bit processor.

Also, unusually for 8 bit microprocessors, it has a multiply and divide instruction. Although it is only running at 1MHz it will outperform a Z80 microprocessor running at 4MHz.

For the purposes of this review I was also loaned a copy of the language PL9. The syntax of this is very much like a cross between Basic and Pascal with the

From Page 119

advantage that it is compiled. That is, once you have written the program it is turned into 6809 machine code.

This machine code is then executed, resulting in an increase in speed over the normal interpretive method. In addition, the machine code produced is "ROM-able", which means it can be placed into a ROM or eprom and built into a dedicated system.

A dedicated system is a micro which will do only one task, typically controlling something like your central heating or a vending machine.

Normally a dedicated system requires programming in machine code and this leads to long development times. However if all or most of the program can be written in a high level language the development is greatly enhanced.

I believe Cambridge Microprocessor Systems can also supply development modules for dedicated systems.

Documentation is usually a weak point in most products but here it is quite good. There is an A5 size spiral bound manual about the software which comes with the processor (Flex and the Editor Assembler).

Also there is a 16 page slim volume detailing information specific to the hardware as well as examples of how to tap the unique features of the BBC Micro.

The documentation that came with the PL9 language could only be described as overwhelming. It was A4 size and an inch thick. Needless to say, in the time allowed for the review I have not managed to read it all.

Although good, the documentation is not aimed at beginners. It is assumed that if you are told something once it will be sufficient. Those who think the BBC User Guide is complex will probably be defeated by this one as well.

Having briefly described the system, who is it aimed at? Basically if you want to run new languages, develop dedicated systems or program in 6809 machine code it is a second processor you should consider carefully, as the alternatives are likely to cost you a lot more.

All in all this is a powerful second processor and one that I wish I could keep after this review.

Mike Cook

Is it time to extend your BBC Basic?

Addcomm

Vine Micros

AS the name suggests, the Addcomm ROM chip adds some new commands to the BBC Micro. I was astonished on first typing *HELP ADDCOMM to see more than two complete screenfuls of new commands and detailed syntax.

In all, 40 extra Basic-like commands are available for use in direct mode or, in most cases, within programs – even in multistatement lines.

The new commands may be divided into three main groups – Graphics (11 commands), Logo/turtle graphics (8 commands) and Utilities (21 commands).

A general impression of the extra functions available may be gleaned from Tables I, II and III.

The combination of a variety of basic toolkit type utilities on the same chip as extended graphics commands is very useful, especially if your sideways ROM slots are at a premium, such as if you do not have a ROM extension board fitted or are an avid chip collector!

The review version was 1.00 and the documentation provided was a pre-release of the inevitable "manual in preparation".

However even this pre-manual covered 15 sides of A4 and was quite adequate to explore the new commands.

Inevitably a few mistakes and some areas of insufficient clarity were present, though I'm sure these will be cleared up in the final manual.

Fitting the chip was straightforward – it simply plugs into a sideways ROM socket – though remember a 1.00 or greater operating system must be present to use it.

The Addcomm chip is fussy as to where it sits, a fact not mentioned in the

supplied documentation.

In a disc-based system unless it occupied a slot between Basic and the DFS a number of commands were ignored. Moving the chip to the socket directly below (to the left of) Basic solved all the problems.

Addcomm seemed to be fully compatible with either the Acorn or Watford DFS (and according to the documentation, works with the Amcom DFS too).

Also, it did not present any incompatibility problems when used alongside 12 other popular sideways ROMs.

The addition of this chip does, however, reserve 256 bytes of work space in user RAM and PAGE defaulted to &F00 (CFS) or &1A00 (DFS). This memory may be regained by switching off the chip (typing Addcomm) and resetting PAGE or pressing Break – though this can be a nuisance after every use of Ctrl + Break (which switches Addcomm on again) and may lead to incompatibility with some software.

Surprise at the *HELP information had turned to amazement by the time I had typed in and run the short program (Program I) shown below.

The use of SCALE – in this case making the x and y axes range from 0 to 100 – made it very easy to understand and remember and use the drawing

```
5 MODE 2
10 SCALE 0,100,0,100
20 CIRCLE 50,50,30
30 ELLIPSE 50,50,30,15
40 CFILL 1,3,3,1
50 FILL 50,50
```

Program I

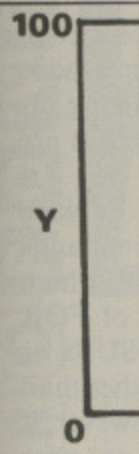

Figure 1

commands.

For example, the CIRCLE command draws a circle with the centre at the origin. This was a higher resolution than the simpler trigonometric or COSINE commands.

The ELLIPSE command was similar to the CIRCLE command, but with a different syntax of two radii. The continuous lines were filled with a pattern of small squares or perimeters.

But why not a part of the colour palette? The coloured lines produced a colour red. The CFILL command

PE
AD
TU
AN
LC
LE
LM
LP

Table

SC
UN
CI
EL
RC
TR
SM
SD
SP
FI
CF

Table

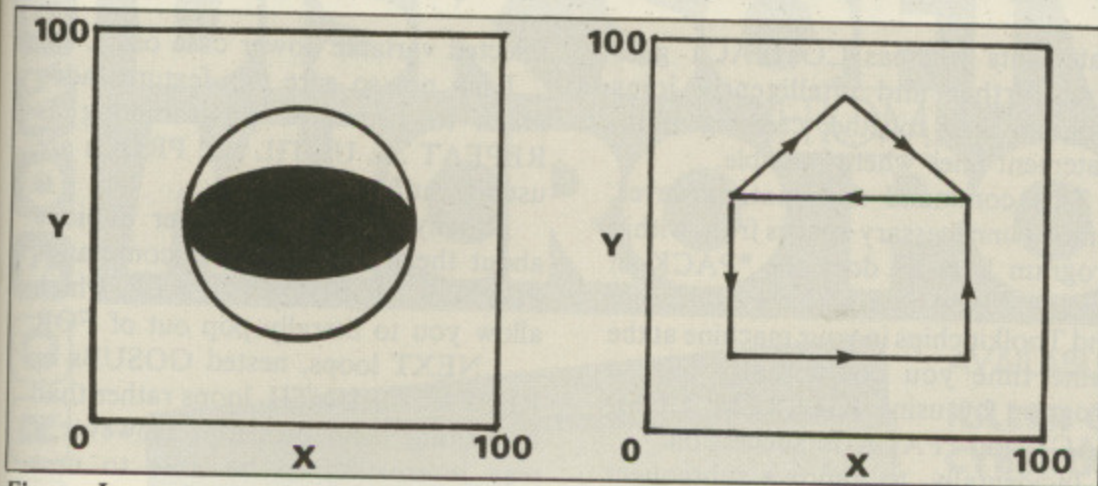

Figure 1

commands.

For example, line 20 draws a CIRCLE of radius 30 units starting at the centre of the screen ($x=50, y=50$). This was much faster, especially in higher resolution modes, and much simpler to use than by employing trigonometrical functions such as SINES or COSINES.

The ELLIPSE command (line 30) was similarly useful. In addition, the syntax of both these commands allowed continuous or dotted lines, empty or filled shapes, or portions of the perimeters (ARCS) to be drawn.

But why the surprise? The filled in part of the drawing (Figure 1) was coloured orange – not one of the BBC colours normally provided. This was produced by a mixture of the logical colour red (1) and yellow (3) in the CFILL command.

You can therefore produce reasonable pinks, pale blues or on a black and white screen various types of shading. Furthermore, the FILL command acts like some of the extra PLOT functions (72-79, 88-85) available in Basic II, whereby extremely complex shapes may be filled in simply by giving the coordinates of any point within the object boundary.

With the addition of ready to use ROTATE and TRANSlocate commands BBC graphics become child's play.

The commands work like Basic and allow for the full passing of Basic variables – very useful in loops.

Implementation of the visual aspects of Logo provides eight commands which enable the user to move an invisible cursor around the screen drawing lines of specified length and

direction.

The commands are designed to be used in conjunction with the extended graphics facilities of Addcomm (SCALE, ROTATE, TRANS) and allow you to simulate the step by step building up of drawings or geometrical figures.

On my first attempt I experienced some difficulty using these commands and moved off in unpredictable directions, but with a little practice and revision of my geometry I was soon able to move in the direction I wished.

It would have been much more helpful – and educational – if a visible arrow-like cursor was available by choice when trying out routines.

Program II illustrates some of the features of Addcomm Logo in action drawing a simple house-shaped figure.

A fair range of useful utilities are available in Addcomm to assist in Basic program development (Table III).

Many of these commands (MEM, FKEYS, FIND, KILLREM) can even be used within programs, though it may not always be advisable.

The commands I used most were those which gave information about the program – MEM, FKEYS, LVAR, and FIND.

MEM, as you might expect, indicates the amount of memory used by the program, the amount reserved for variables (after a program run), and the amount of free memory. Values are displayed in both decimal and hexadecimal.

This command is similar to the *FREE in Beebugsoft's Toolkit ROM but doesn't give details about PAGE, TOP, LOMEM and HIMEM.

LOGO COMMANDS

PEN	Defines type of plot, for example continuous or dotted.
ADVANCE	Draws line for specified distance.
TURN	Changes direction of Logo cursor.
ANGLE	Initialises direction of Logo cursor.
LCIRCLE	Draws circle with Logo cursor as centre.
LELLIPSE	Draws ellipse with Logo cursor as centre.
LMOVE	Moves Logo cursor to specified position.
LPOS	Returns position of cursor.

Table I

GRAPHICS COMMANDS

SCALE	Sets own screen scale for graphic commands.
UNSCALE	Reverts to normal BBC screen coordinates.
CIRCLE	Draws circle of specified size and position.
ELLIPSE	Draws ellipse of specified size and position.
ROTATE	Rotates figure by specified angle.
TRANS	Translocate figure to new position.
SMOVE	As for Basic MOVE but uses set scale.
SDRAW	As for Basic DRAW but uses set scale.
SPLOT	As for Basic PLOT but uses set scale.
FILL	Fills in colour in desired position.
CFILL	Mixes required colour.

Table II

```

5 MODE 4
10 SCALE 0,100,0,100
20 ROTATE 0,0,0
30 TRANS 0,0
40 ANGLE 270
50 LMOVE 20,60
60 FOR sides = 1 TO 2
70 ADVANCE 40
80 TURN 90
90 ADVANCE 60
100 TURN 90
110 NEXT sides
120 TURN 130
130 ADVANCE 39
140 TURN 280
150 ADVANCE 39
    
```

Program II

M I C R O P O W E R M I C R O P O W E R M I C R O P O W E R

DISK SOFTWARE FROM MICRO POWER



AVAILABLE FOR THE FOLLOWING TITLES:
**KILLER GORILLA; THE MINE;
CYBERTRON MISSION; STOCK CAR;
BLOCKBUSTER; RUBBLE TROUBLE;
FRENZY; FELIX IN THE FACTORY;
GHOULS; JET POWER JACK.**



PLEASE ADD 55p
TO EACH ORDER TO
COVER POSTAGE
AND PACKING.

**£9.95
EACH**

- All 10 games are packaged with full colour artwork in an A5 vinyl sleeve.
- Each disk will work on both 40 and 80 track drives.
- Instructions and screen photograph on the back cover.
- Available NOW from your local dealer or by mail order.

SPECIAL OFFER: Return your Micro Power cassette enclosing £4.95 for the disk version or come along to our stand at the Acorn User Show 16-19 August.
NOTE: The rest of our range of titles for the BBC Micro (except Filer and Draw) will also be available on disk but without the colour packaging. These programs will be available from the beginning of August and by mail order ONLY.

M I C R O
P O W E R

MICRO POWER LTD.,
Sheepscar House,
Sheepscar Street South,
Leeds LS7 1AD
Tel: 0532 436300

SEE US AT
The 2nd
Official
Acorn User
Exhibition
OLYMPIA
16-19 AUGUST
1984



M I C R O P O W E R M I C R O P O W E R M I C R O P O W E R

CLEARLY HE HAD ONLY ONE KEYBOARD IN MIND WHEN HE DESIGNED THE HUMAN HAND

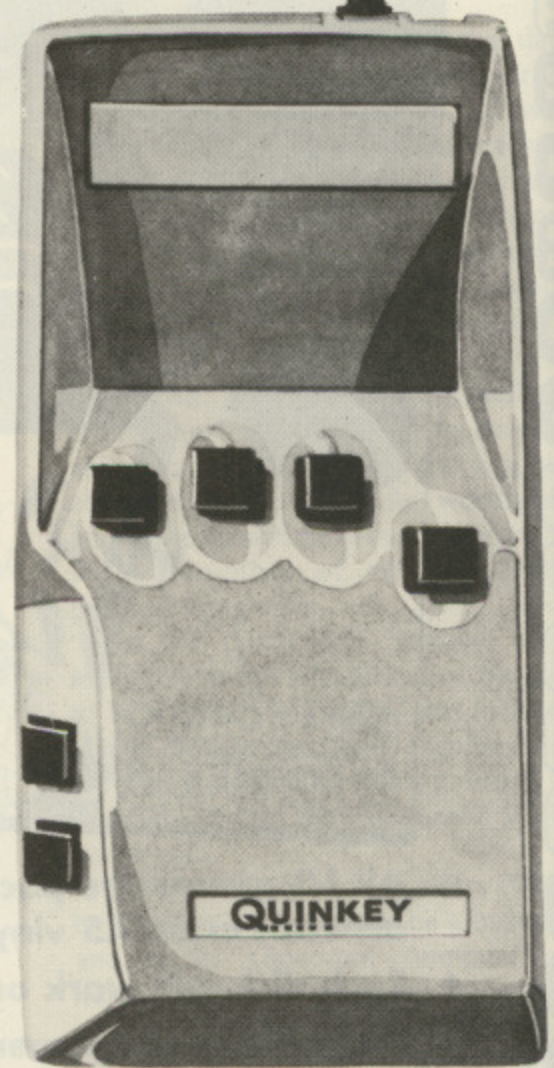

IMAGINE A KEYBOARD

... so simple to use that in under an hour you're touch typing the entire alphabet, numbers and punctuation.

... so effortless it needs only one hand, your eyes never leaving the screen or the document you're copying.

A keyboard you can hold in your palm, and yet, so powerful, it can replace every input, command and function key of your BBC computer ...

Just think how effortless it would be if you could touch type your programs, data and text.

How you could lean back and relax; be faster and more accurate; your mind free to think, and your eyes to read.

IT'S CALLED **QUINKEY**

And for **£49.95** you'll get everything you need — hardware and software — to use Quinkey with your BBC computer.

HOW CAN 6 KEYS DO THE WORK OF 72?

You simply press the keys in different combinations. Each combination represents a character.

Quinkey has 5 keys plus a Control key, each finger belonging to its own key — so there's no need to hunt and peck ... BUT ...

... HERE'S THE MAGIC!

Look at these diagrams:

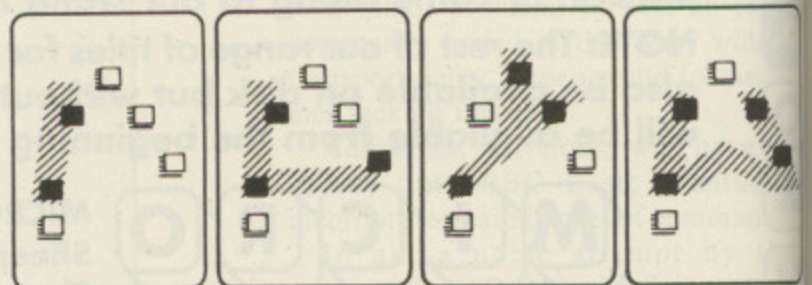

See how the lines joining the key combinations form the characters? For each letter there's an instantly recognised and easily memorised visual clue.

That's the trick — and it works!

YOU

Res

Imagin

To v

down a

For

fingers

To v

fingers

Tha

Her

— PETE

World'

easier t

starting

— PETE

Supple

hour's u

— FRAN

Times

so gene

NO R

If yo

within

ONLY

HERE'S

★ One

★ Bre

keyb

★ Two

(des

★ Com

"PR

utility p

"PR

the sign

with yo

Quinkey

"WE

process

a perfec

KEYBO

All E

Quinkey

TECHNIC

Loading le

No zero-p

Interrupt s

TESTED C

BBC Mode

OS 1.2

BASIC I or

INKEY wi

DFS 0.90

View A1.4

Wordwise

Edword

YOU CAN TRY IT NOW!

Rest the fingers of your right hand on a table top. Imagine the keys.

To write an "I" you press your Thumb and Index finger down at the same time.

For an "L" you press your Thumb, Index and Little fingers.

To write "Y" you use your Thumb, Middle and Ring fingers . . . and so on.

That's all there is to it.

Here's what users are saying about the keyboard:

-PETER RODWELL (as Editor of 'Personal Computer World') "took me half an hour to learn the alphabet . . . far easier than learning to type. It's an addictive device, and I'm starting to wonder how I ever managed without one."

-PETER WHEELER (in the 'Times Educational Supplement') "a new user can start to touch type after one hour's usage."

-FRANK DALE (BBC Producer - writing in 'Electronic Times') "no other machine is so easy to use, so easy to learn, so generally useful . . ."

NO RISK, MONEY BACK GUARANTEE.

If you're unhappy with your Quinkey just return it within two weeks for a full and courteous refund.

ONLY £49.95 (including VAT and postage & packing).
HERE'S WHAT YOU GET.

- * One Quinkey keyboard.
- * Breakthrough multi-channel interface for up to four keyboards (plug into analogue port).
- * Two new powerful software packages, PROG & WP (described below).
- * Comprehensive Quinkey manual.

"PROG" and "WP" (free with the Quinkey package) are utility programs written specially for the BBC.

"PROG" enables your BBC to recognise and interpret the signals from the Quinkey keyboard. It combines easily with your application programs enabling you to use Quinkey as a comprehensive alternative keyboard.

"WP" optimises Quinkey to work with word-processing packages "Wordwise," "View" and "Edword" - a perfect text-writing combination.

KEYBOARD RANGE.

All BBC "B" keyboard inputs generate from the Quinkey, except the hard-wire key, "Break."

TECHNICAL DATA:

Leading length: &605. Running length: &300.
No zero-page locations, all ADC channels.
Interrupt service vector IRQ2V, correctly chained.

TESTED COMPATIBILITY

BBC Model "B"	Acorn
OS 1.2	
BASIC I or BASIC II (unless using Quinkey with negative argument)	Acorn
FS 0.90	Acorn
View A1.4	Acornsoft
Wordwise 1.17	Computer Concepts
Edword	Clwyd Technics *

QUINKEY IN THE CLASSROOM.

Quinkey keyboards allow up to four children to use one BBC computer at the same time. "QUAD" software supplied with the Educational Pack enables children to write simultaneously on a split screen and print out their work separately.

(Send the coupon if you would like more information about the remarkable results that children of all ages and abilities are having with Quinkey.)

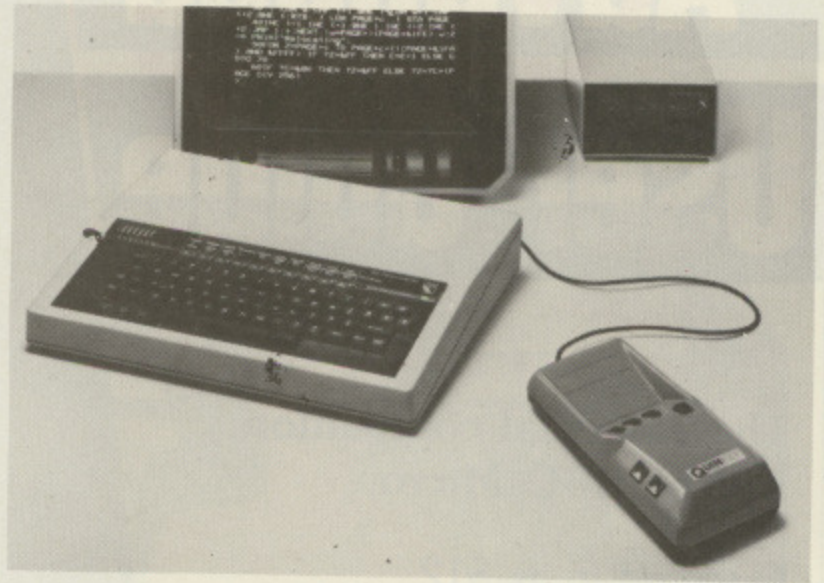

Order by sending in the coupon below, now.

microwriter

An associate company of the Hambro Life Group of Companies

31 Southampton Row, London WC1B 5HJ

To: Vector Marketing Ltd., Denington Estate, Wellingborough, Northants. NN8 2RL.

PLEASE SEND:

001	Quinkey pack(s) @ £49.95	£	_____
002	Extra keyboard(s) @ £29.95	£	_____
003	Educational Pack(s) @ £148.80 (Quinkey pack plus 3 extra keyboards and additional "QUAD" software)	£	_____
+ postage and packing		£	2.50

I realise that I can return the pack(s) undamaged within two weeks of receipt of order, if I am not fully satisfied, for a complete refund.

Send more information about Quinkey in the classroom.

I enclose a cheque made payable to:

Vector Marketing "Microwriter Ltd" for £ _____

Or debit my Visa/Access credit card No. _____

SIGNED: _____

NAME: _____

ADDRESS: _____

MJ10/84

Please allow up to 28 days for delivery.

Reg. no. 1374069

microwriter
QUINKEY

THE BEST IDEA SINCE THE HUMAN HAND

Don't miss
this special
summer offer

The Advanced User Guide

The essential companion
for the BBC Micro.

Featured in its 512
information packed pages
are

- ★ the BASIC Assembler
- ★ 6502 machine code reference section
- ★ complete descriptions of all FX calls
- ★ BBC memory usage and vectors explained
- ★ full interfacing details for the user port, tube, analogue port, 1 MHz bus
- ★ paged ROMs explained
- ★ and lots, lots more

With many examples to illustrate the text, this guide is the indispensable reference work for the serious BBC micro programmer.

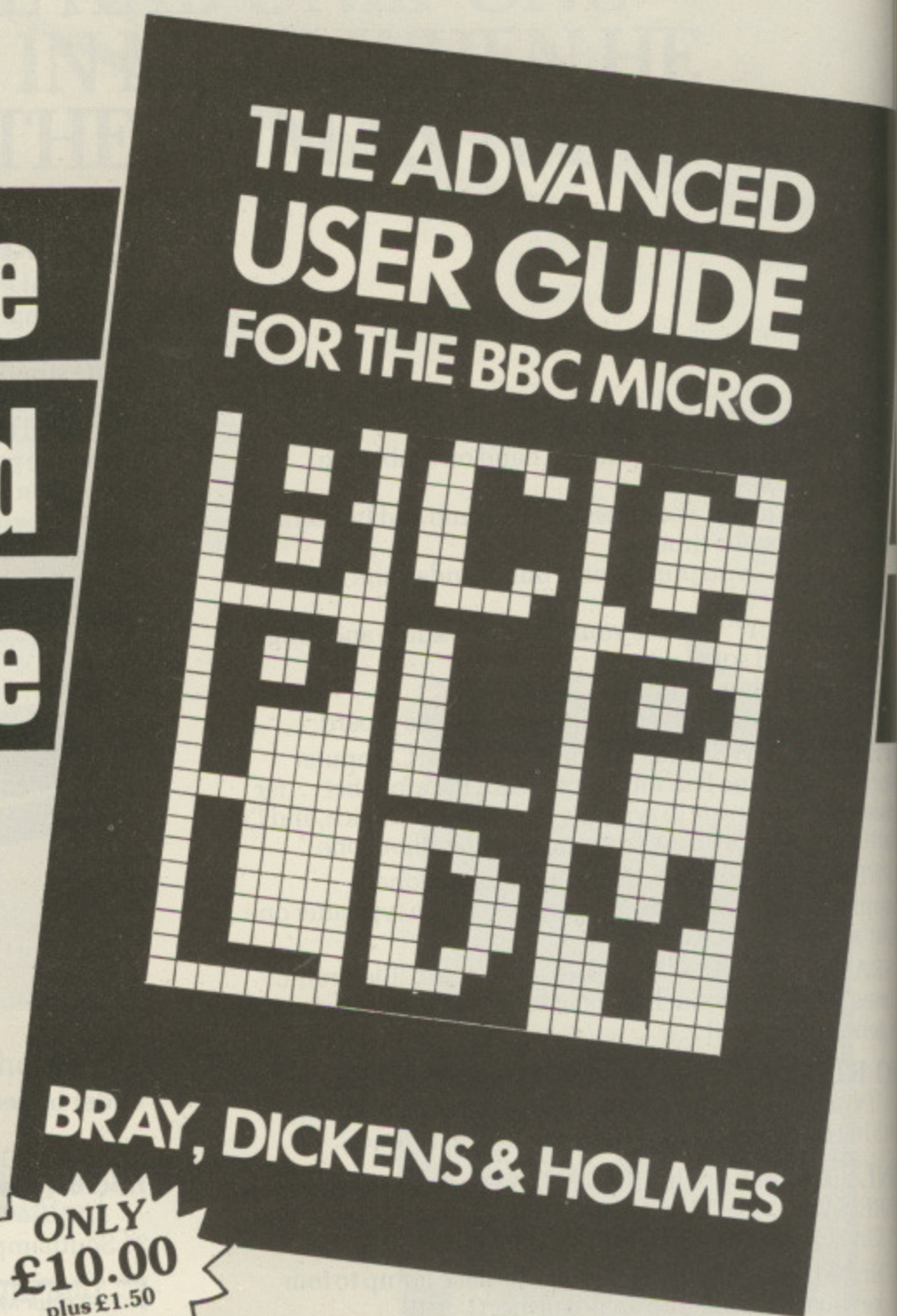

**ONLY
£10.00**
plus £1.50
p&p

ORDER BY POST TODAY!

Please send me copies of The Advanced User Guide
at £11.50 (inc. p&p) TOTAL £

Name

Address

.....

.....

Please indicate method of payment (✓)

Cheque/PO made payable to Database Publications Ltd.

Access/Mastercharge/Eurocard

Barclaycard/Visa

American Express

Card No.
.....

Expiry date
.....

Signed

Send to: Micro User, FREEPOST,
Europa House, 68 Chester Road,
Hazel Grove, Stockport SK7 5NY.
(No stamp needed if posted in UK).

Or you can order by phone quoting
credit card number and expiry date.
061-480 0171

Now No. 1 BBC
game on Micro Deal
Top Fifty chart

YOU can go for gold ...with the



Fancy pitting yourself against the world's best at this summer's Olympics?

You can do so without going anywhere near Los Angeles – with the most challenging package of programs of 1984.

MICRO OLYMPICS is more than a game. It's a brilliantly written collection of ELEVEN track and field events.

And because we know we're going to sell many thousands of them we've brought the price right down – to just £5.95.

Ever imagined yourself as another Seb Coe? Then try to run against the world record holder at 1500 metres. And if that distance is too much for you then there's always the 100, 200, 400 and 800 metres to have a go at.

Not much good at running? Don't worry, MICRO OLYMPICS has many more challenges for you. Why not try your skill at the high jump or the long jump?

And if you can't beat the computer at running or jumping then you can always throw things around in frustration! The trouble is that it's just as hard to be a champion at the discus, the hammer or the javelin.

And the pole vault takes the event to new heights!

Yes, it's fast, furious fun, pitting yourself against the world's best times and distances on your micro.

You may not be another Steve Ovett or Alan Wells, but with practice you COULD become the Micro Olympics Champion!

Also available from WHSmith
and all other leading stores



**Play Micro Olympics
– and let your fingers
do the running!**

Send for it today

Please send me _____ copy/copies of
Micro Olympics

I enclose cheque made payable to
Database Publications Ltd.
for £ _____

I wish to pay by

Access Visa No. _____ Expiry date _____

Signed _____

Name _____

Address _____

- | | |
|--|-------|
| <input type="checkbox"/> BBC 'B' cassette | £5.95 |
| <input type="checkbox"/> Electron cassette | £5.95 |
| <input type="checkbox"/> BBC 40-track disc | £7.95 |
| <input type="checkbox"/> BBC 80-track disc | £7.95 |

Please tick box

Post to: Micro Olympics offer, Database Publications,
68 Chester Road, Hazel Grove, Stockport SK7 5NY.

Organised by
The Micro User
and Electron User

Come to our great proCh

Yes, we're back again at the spacious
ALEXANDRA PALACE - where there's
plenty of room to move around and inspect
all the latest micro goodies at your leisure!

**Look what
you can
see . . .
try . . .
and buy!**

BBC Micros Electrons

Teletext adapters
Torch disc packs
BBC Buggies
Second
Processors
Mouses
ROM Expansion
Boards
Grafpads
Books
Joysticks
Interfaces
Disc drives
Data recorders
Lightpens
Modems
Speech
Synthesisers
Carrying Cases
Cables
Digitizers
VDU stands
Graphics tablets
ROM chips
Monitors
Printers

Everyone who is anyone in the exciting world of the BBC Micro and Electron will be at our greatest ever autumn show. And that includes all the big names you see advertising in the pages of our magazines.

Waiting for you will be more than 150 stands, packed with hardware, software and peripherals - some on show for the first time.

And everything will be for sale - much at really low, show prices!

Once again our team of writers will be there to give you free advice - an ideal opportunity to find out all the facts on the latest computing techniques. Don't miss this chance to meet in person the names you see in these pages every month!

Free buses!

To get you to the show as easily as possible we are running free Show Buses from Alexandra Palace station, leaving every 10 minutes.

Free parking!

There's plenty of free parking, too. All part of the service to make this an enjoyable and relaxing computer day out!

OPENING HOURS

10am-5pm	Thursday, 25 October
10am-5pm	Friday, 26 October
10am-5pm	Saturday, 27 October
10am-4pm	Sunday, 28 October



Thi

**Red
Sch
Gro**

Entry
booki
advan
(made
Public

Electro
68 Ch
Stockp
Tel: 06
Valid for

preChristmas bonanza!

ous
re's
ect
ure!

Thursday to Sunday
October 25 to 28

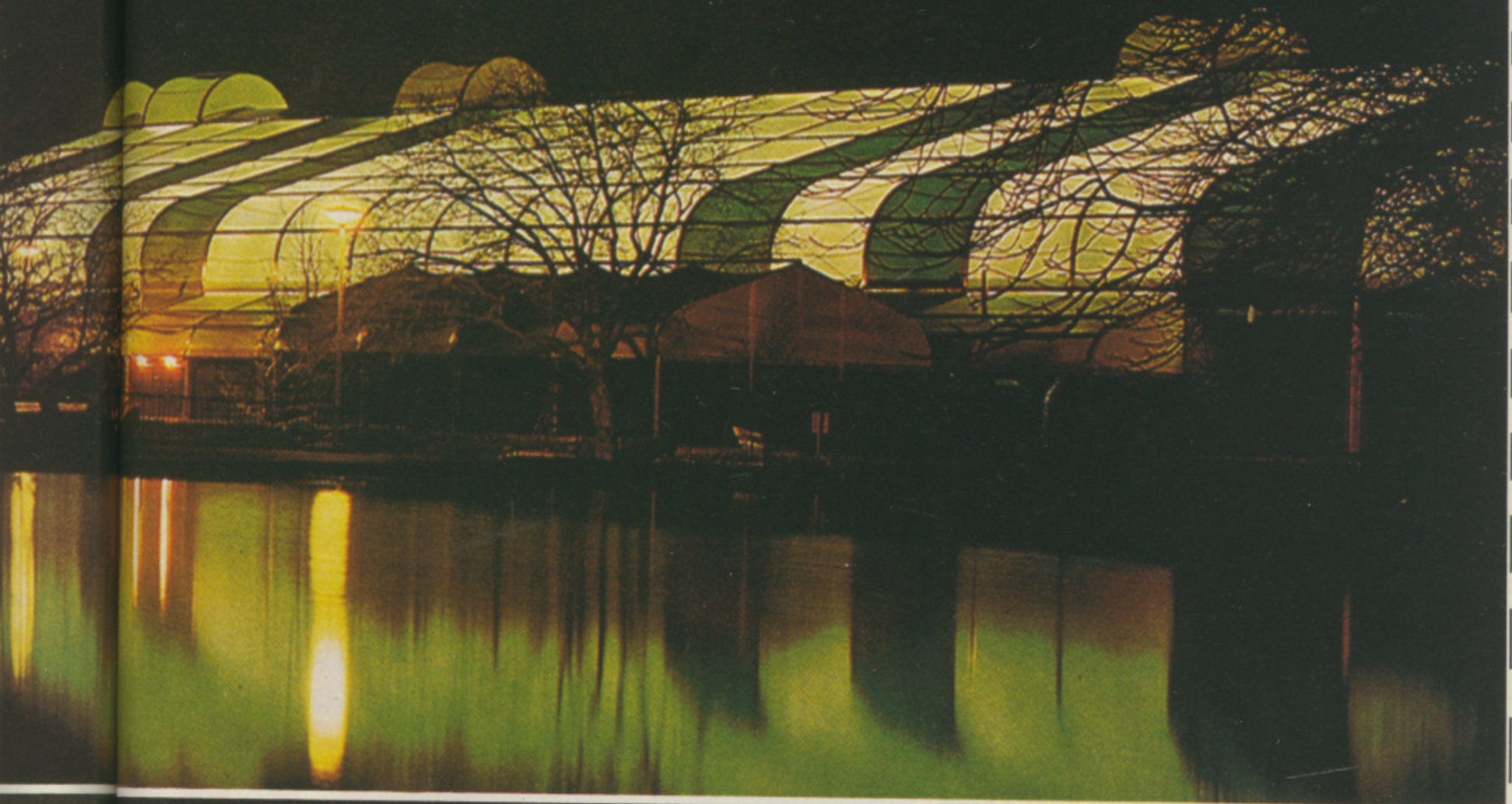

This voucher is worth £1 per head

Reduced prices for School/College Groups

Entry only £1 per student if bookings are made in advance. Send your cheque (made payable to Database Publications) and SAE to:

Electron & BBC Micro User Show
68 Chester Road, Hazel Grove,
Stockport SK7 5NY
Tel: 061-456 8383
Valid for a minimum of 10 people

SAVE MONEY with our Special Travel and Hotel Offer

Visitors to the Show can obtain cut-price rail tickets from ANY station in the United Kingdom - plus special reduced prices at London hotels. Write to:

Travel Offer, P.O. Box 1, St. Albans AL1 4ED with SAE or Telephone: St Albans 34475 quoting: The Electron & BBC Micro User Show.



By handing in this voucher at the door you save £1 off the normal admission price of £3 (adults) and £2 (children).

(Valid for a maximum of 4 people)

10am-5pm, Thursday, 25 October
10am-5pm, Friday, 26 October
10am-5pm, Saturday, 27 October
10am-4pm, Sunday, 28 October

**Alexandra Palace
Wood Green, London N22.**

Number attending: 1 2 3 4

Level 9 Adventures are superbly designed and programmed, the contents first rate.

YOUR 64 June 84

✓ Whichever machine you own, if you have the vaguest tendency towards adventure playing then you must try one of these games (unfortunately you'll probably end up wanting to buy the lot!).

Computing Today, August 84

✓ To me, all Level 9 adventures create a remarkable atmosphere because the descriptions sound so life-like. This is where so many other adventures fail.

Crash, July 84

✓ But it's not just the size of the game it's the quality as well that is astonishing ... scenes to fire the imagination.

PCG, April 84

✓ As in all Level 9's adventures, the real pleasure comes not from scoring points but in exploring the world in which the game is set and learning about its denizens.

Which Micro?, February 84

✓ I thoroughly recommend these Adventures, they are excellent value for money. No self-respecting Adventure-addict should be without them. I believe Level 9 are producing a series of Adventures which should be regarded as classics.

Atari User, July 84

✓ These programs run very fast and there are no frustrating pauses. Level 9 Adventures are superbly designed and programmed, the contents first rate. The implementation of Colossal Adventure is nothing short of brilliance; rush out and buy it. While you're at it, buy their others too. Simply smashing!

Your 64, June 84

✓ Level 9 — arguably the producer of the best adventure games in the UK — has done it again. LORDS OF TIME is a sparkling addition to its stable of winners.

Acom User, July 84

✓ (SNOWBALL). This is another imaginative, massive-scaled immensely enjoyable adventure from those experts down at Level 9 Computing.

Your Computer, March 84

Adventure Quest



Level 9 Computing

Adventure Quest is the second in Level 9's acclaimed Middle Earth trilogy, though it can be played by itself.

Available from W H Smith and good computer shops everywhere. If your local dealer doesn't stock Level 9 adventures yet, get him to contact us or: Centresoft, Microdealer UK, Ferranti & Craig, Leisuresoft, Lime Tree, LVL, PCS, R & R or Wonderbridge.

his
ur
7
ptember 83

Level 9 specialise in huge adventure games, cramming over 200 locations and a host of puzzles into your micro. We take care when designing games—writing them like stories with detailed settings and sensible reasons for the puzzles. They are solved by inspiration—not luck.



1. **COLOSSAL ADVENTURE** The classic mainframe game "Adventure", with all the original puzzles plus 70 extra rooms.
2. **ADVENTURE QUEST** An epic puzzle journey through Middle Earth.
3. **DUNGEON ADVENTURE** Over 100 puzzles to solve and 40 treasures to find.
4. **SNOWBALL** Save the interstar freezer, Snowball 9, in a huge space adventure with over 700 locations.
5. **LORDS OF TIME** An imaginative romp through World History.

I ENCLOSE A CHEQUE/PO FOR \$9 EACH

My name:

My address

My micro is a:

(one of those listed below, with at least 32K of memory)

Contact:

LEVEL 9 COMPUTING

Dept. , 229, Hughenden Road, High Wycombe, Bucks. HP13 5EP

OPENUP YOUR COMPUTERS POTENTIAL

WITH **BEL BASE** AND **MAILSHOT** FROM **BEL TECH**

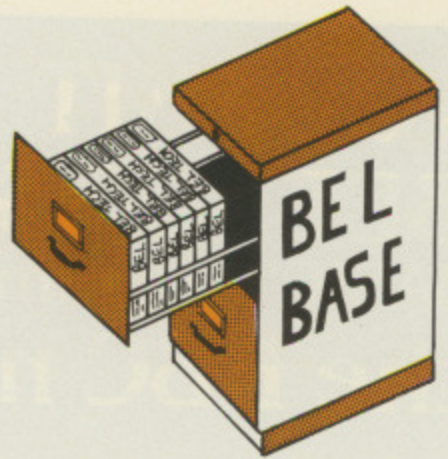

FLEXIBLE, POWERFUL, COMPREHENSIVE YET MENU DRIVEN AND EASY TO USE and INCREDIBLE VALUE FOR MONEY !!!

- * Up to 20 FIELDS and 150 CHARACTERS PER RECORD (480 CHARACTERS PER RECORD ON DISC)
- * 600 RECORDS or 90K Characters per File with truly RANDOM ACCESS Disc Version (15K Characters per File on Tape)
- * DEFAULT Values can be set
- * SELECT Disc Drives (0 to 3)
- * CALCULATION Options. Calculate a Field from the value of others, enter Functions etc. — and change them!
- * AMEND the Name, Type, Default Value of any Field
- * SEARCH and REPLACE on all Fields, all Records
- * SELECTIVE and GLOBAL EDITING of Records
- * INSERT Records, DELETE a Field or Record
- * BROWSE Option
- * FIND (Search on any Field) Print Screen if required
- * DISPLAY or PRINT Reports (max. 38/137 characters across)
- * PRINT all Records (20 Fields) or all Data
- * FORMAT OWN REPORTS (Heading, up to 20 Fields, select, sort etc.)
- * SORT on any Field (Ascending/Descending) whether Printed or not
- * SET CONDITIONS (<, >, <>, =, >=, <=) on any Field, printed or not
- * SAVE Report Formats to a File
- * SUM Numeric Fields
- * SEND Printer Control Characters
- * COMPREHENSIVE INSTRUCTIONS SUPPLIED

NOW AVAILABLE ON ROM
MAILSHOT — £36
BEL BASE — £69



MAILSHOT IS INCLUDED IN PRICE OF BEL BASE AS A BARGAIN PACKAGE!!

PERSONAL USE, BUSINESS, ACCOUNTS, EDUCATION, CLUBS, SOCIETIES, FUNCTION, GENERATION — JUST KEEP THINKING OF NEW APPLICATIONS!

AND 'MAILSHOT' SEPARATELY:—

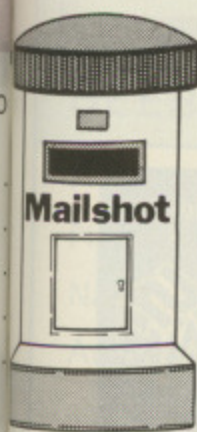

- * USE AS MINI DATA BASE
- * Field, Record Size, Amend, Edit, Search, Insert, Replace, Drive Selection, Browse, Find, Sort, Conditions, Printer Control as BEL BASE above.
- + * LABEL Printing (Std., non std, 1, 2, 3, across)
- + * PRINT any 6 Fields Across
- + * PRINT any 6 Fields Down

Order Form	TAPE		DISC		TOTAL
	QTY		QTY		
BEL BASE	16.00		18.00		
BEL GRAPH	15.00		17.00		
BEL CHEM Chemistry 1	9.50		11.50		
Chemistry 2	9.50		11.50		
BEL GEN Geneology	12.50		14.50		
MAIL SHOT	9.50		11.50		

TOTAL inc. P. & P. £

NAME _____
 ADDRESS _____

 COMPUTER TYPE _____ MODEL _____
 DISC (if applic.) _____
 CREDIT CARD No. PAYMENT BY CHEQUE, P.O., VISA, ACCESS

Please Complete & Return to:-
 BEL TECH Limited, Stanmore Industrial Estate, Bndgnorth, Shropshire, WV15 5HP. or
 Telephone: 07462 5420 (24 Hrs.)

FILES ARE COMPATIBLE WITH BEL GRAPH

TOOLKIT ROM from BEEBUGSOFT

BASIC Programmer's Aid for the BBC micro



©BEEBUGSOFT 1984

- 27 new commands to make life easier
- Saves hours in program development and debugging
- Supports both cassette and disc systems
- No command name conflict with other Roms
- Ideal for expert and novice alike
- Fitting instructions and a 32 page manual supplied
- You'll wonder how you ever managed without it

SPECIAL FEATURES INCLUDE

SCREEN EDITOR An extremely powerful editor, allowing the use of cursor keys to list a program line-by-line in either direction and move to any part of a program to overtype or insert new code and corrections.

ERROR DETECTION Powerful facility to trap an error in a Basic program as it runs. It will then automatically enter the Screen Editor, display the line in error and position the cursor close to the statement at fault.

"TOOLKIT is an essential utility for all Basic programmers using the BBC Micro. . . . The range is enormous. . . an indispensable aid packed full of powerful utilities."

EDUCATIONAL COMPUTING MARCH 1984

"... highly recommended."

PCN MARCH 17 1984

"The Beebugsoft Toolkit costs £27 and in my opinion is worth every penny. Since it has been installed in my BBC it has been used extensively and I can find no fault with it. Highly recommended to lazy programmers!"

COMPUTING TODAY JUNE 1984

COMMANDS

*CHECK	Verify a program or data in memory with disc/cassette.
*CLEAR	Clear all variables including integers.
*EDIT	Enter full screen editor.
*FREE	Display free memory and pseudo variables.
*HELP INFO	Display a screenful of useful system information.
*MEMORY	Display memory contents.
*MERGE	Merge a program in memory with one on disc/cassette.
*MOVE	Move program to run at specified address.
*NEW	As NEW, but can be issued from within a program.
*OFF	Cancel enhanced error handling.
*OLD	As OLD, but can be issued from within a program.
*ON	Auto error handling—enters editor at line in error.
*PACK	Efficient program compactor.
*RECOVER	Intelligently recover bad programs.
*RENUMBER	Allow partial renumbering.
*REPORT	Extended error reporting facility.
*SCREEN	Screen dump to cassette or disc.
*UTIL	Display utilities menu.
*UTIL 1	String search.
*UTIL 2	String search and replace.
*UTIL 3	Move Basic program lines.
*UTIL 4	List procedures and functions.
*UTIL 5	List values of A% to Z%.
*UTIL 6	List numeric variables.
*UTIL 7	List string variables.
*UTIL 8	List names of arrays.
*UTIL 9	Set up range for utilities 1 and 2.

BEEBUGSOFT, PO BOX 109, HIGH WYCOMBE, BUCKS HP10 8HQ

Please send me.....Toolkit(s) at £27.00 each

Name

Address

Send Cheque/Postal Order to BEEBUGSOFT,
DEPT 16 , PO BOX 109, HIGH WYCOMBE, BUCKS HP10 8HQ
(Distribution agents for BEEBUG Publications Ltd.)

Available from your dealer
and selected branches of
W.H. Smiths

£27.00

Including
VAT & P&P



SEE ALSO BEEBUGSOFT DOUBLE COLOUR ADVERT IN THIS ISSUE.

SERIOUS SOFTWARE from BEEBUGSOFT.

Design (C.A.D. Pack)

DESIGN is a screen processor which allows information to be displayed in a format suitable for demonstrations, slide projections, handouts or presentations.

Graphs, Pie Charts and Bar Charts are quickly produced on automatically drawn and scaled axes.

Text may be written anywhere on the screen and may be displayed normally, enlarged, underlined or sideways.

Twenty user-defined characters and four large macro characters are supplied, and may be placed anywhere on the screen or redefined as required. Additionally a set of characters for circuit diagram generation is also included.

Machine code screen dumps are included for Epson, Seikosha, Shinwa and Star printers and details on how to load dumps for other printers are also included.

Screens may also be saved and reloaded to cassette or disc.

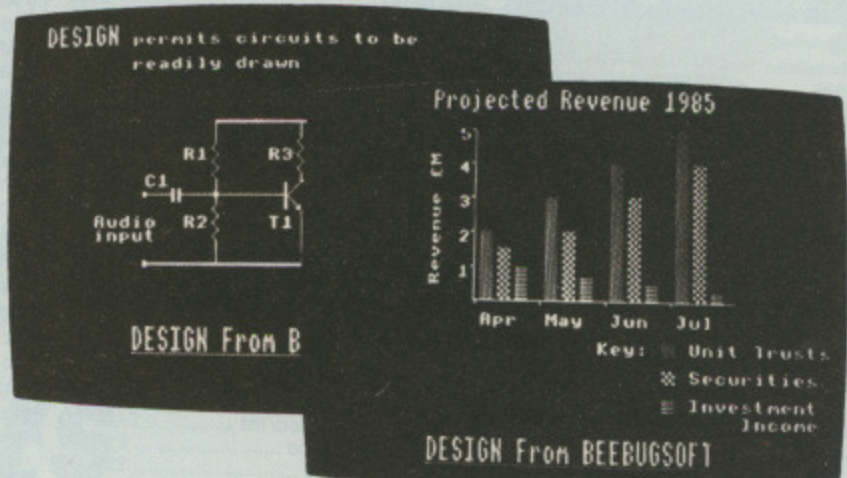

".... A first rate screen processor.... immense value to schools and colleges ideal tool for preparing display material...."

EDUCATIONAL COMPUTING APRIL 1984

Sprite Utilities

SPRITE UTILITIES A game writers utility pack which allows high speed arcade games to be written in Basic.

This is achieved by using the set of supplied machine code sprite routines to move multi-coloured characters (sprites), of your own design, around the screen at high speed.

Control of the sprites' movements is by user written Basic program. Specific commands to the sprites are very simple.

Sprites are generated in mode 2 on a 8 x 16 grid and may include any of the available 16 colours.

Up to seven sprites may be displayed and controlled on the screen at any one time. A special super sprite facility enables clones of each sprite to be created, to provide animation.

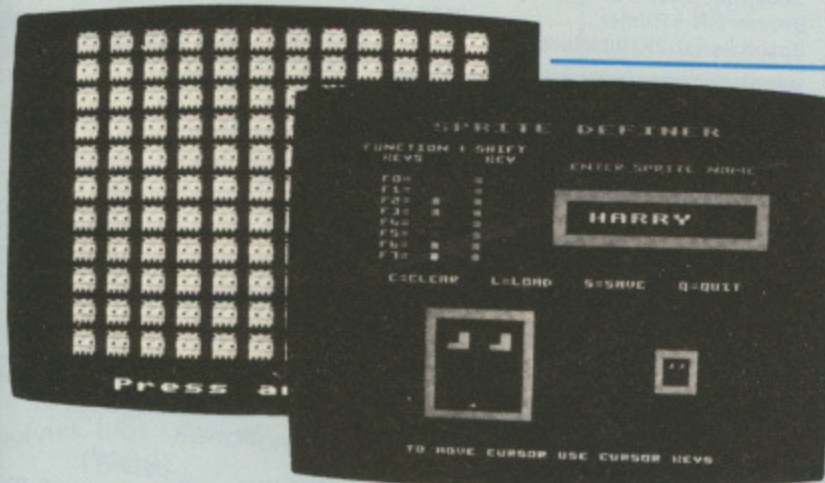

".... Definitely recommended...."

ELECTRONICS & COMPUTING MAY 1984

".... For my money Sprite Utilities wins through...."

ACORN USER MAY 1984

BEEBUGSOFT, P.O. BOX 109, HIGH WYCOMBE, BUCKS. HP10 8HQ

Please send me Design Disc(s) at £19.00 each

..... Design Cassettes at £10.00 each

Please send me Sprites Disc(s) at £12.00 each

..... Sprites Cassettes at £10.00 each

Name

Address

All BEEBUGSOFT products are available from leading dealers including larger branches of W.H. Smith



Send Cheque/Postal Orders to BEEBUGSOFT DEPT. 16 P.O. BOX 109, HIGH WYCOMBE, BUCKS. HP10 8HQ
(Distribution agents for BEEBUG Publications Ltd.)

p h

p&h electronics Ltd

5 THE PARADE, YATELEY 22/24 GUILDFORD ROAD

NEAR CAMBERLEY, SURREY
Tel: Yateley 0252 877222

BAGSHOT, SURREY
Tel: Bagshot 0276 73078



MICRO CENTRES

TELEPHONE OR VISIT ALL PRICES INCLUDE VAT

ACORNSOFT

EDUCATION	
Algebraic Manipulation	£9.95
Peeko Computer	£9.95
Business Games	£9.95
Tree of Knowledge (*E £9.20)	£9.95
Word Hunt	£11.90
Word Sequencing	£11.90
Sentence Sequencing	£11.90
Number Balance	£11.90
Missing Signs	£11.90
Chemical Analysis	£13.80
Chemical Simulations	£13.80
Chemical Structures	£13.80
Jars	£11.90
Temperature Control	£9.95
The Examiner	£9.95
LANGUAGES	
Forth (*E £16.10)	£16.85
Lisp (*E £16.10)	£16.85
Microtext	£49.85
Turtle	£16.85
S-Pascal	£16.85
GRAPHICS AND OTHER	
Creative Graphics (*E £9.20)	£9.95
Graphs + Charts (*E £9.20)	£9.95
Picture Maker	£9.95
Shirley Conran's Magic Garden	£9.95
Collector's Catalogue	£9.95
Membership Manager	£9.95
Linkword - French	*E £14.95
Linkword - Italian	*E £14.95
Linkword - Spanish	*E £14.95
Linkword - German	*E £14.95
BUSINESS	
Desk Diary	£9.95
Forecast	£11.90
View Printer Drivers	£9.95
Personal Money Management (*E £11.50)	£11.90
Database	£11.90
GAMES	
Philosophers Quest	£9.95
Aviator (Disk £17.85)	£14.95
Monsters (*E £9.20)	£9.95
Snapper	£9.95
Rocket Raid (Disk £11.50)	£9.95
Arcade Action	£11.90
Sphinx Adventure (*E £9.20)	£9.95
Cube Master	£9.95
JCB Digger (Disk £11.50)	£9.95
Chess (*E £9.20)	£9.95
Sliding Block	£9.95
Meteors (Disk £11.50) (*E £9.20)	£9.95
Arcadians (*E £9.20)	£9.95
Planetoid	£9.95
Super Invaders (Disk £11.50)	£9.95
Castle of Riddles	£9.95
Missile Base	£9.95
Downton to Doom	£9.95
Draughts and Reversi (*E £9.20)	£9.95
Snooker (Disk £11.50)	£9.95
Starship Command (*E £9.20)	£9.95
Hopper (Disk £11.50) (*E £9.20)	£9.95
Carousel	£9.95
Kingdom of Hamil	£9.95
Crazy Tracer	£9.95

Drogna	£9.95
Free Fall (*E £9.20)	£9.95
Meteor Mission	£9.95
Gateway to Karos	£9.95
Tetrapod	£9.95

ACORN/MIRLE BUSINESS SOFTWARE (Disk - 40 Track)	
Invoicing	£24.95
Mailing System	£24.95
Accounts Receivable	£24.95
Stock Control	£24.95
Order Processing	£24.95
Accounts Payable	£24.95
Purchasing	£24.95

BBC/ELECTRON

Acorn Electron + Cover	£199.00
Electron Exp 1	£59.00
BBC Model A + Cover	£299.00
BBC Model B Start Pack	£399.00
BBC Model B + Disc/Int	£469.00
BBC Disc Interface	£95.00
Speech Interface	£54.00
BBC Teletext Receiver	£220.00
6502 Second Processor	£190.00
Bit Stick	£390.00
Z80 Second Processor	£299.00

DISC DRIVES

Acorn/LVL 100K expands to double	£199.00
Acorn/LVL dual 100K	£350.00
Pace slim 100K	£160.00
Cumana 100K no P. supply	£165.00
Cumana 200K no P. supply	£180.00
Cumana 400K no P. supply	£240.00
Cumana 100K with P. supply	£190.00
Cumana 200K with P. supply	£220.00
Cumana 400K with P. supply	£250.00
Cumana dual 100K	£350.00
Cumana dual 200K	£370.00
Cumana dual 400K	£480.00
Cumana dual 200K 40/80 switched	£450.00
Cumana dual 400K 40/80 switched	£550.00
LVLDD disc int kit	£115.00
Acorn DFS kit	P.O.A.
Torch pack	£799.00

ACCESSORIES

Cassette Recorder	£24.00
Cassette with Counter + Din	£29.00
Joysticks SW Self-Cen PR	£17.50
J/S Analogue Self-Cen (LVL) PR	£20.00
Crackshot Joystick	£10.95

Micro Dust Cover	£5.00
R.H. ELE Light Pen	£44.00
TV Aerial/Computer Switch	£2.50
Plinth for Monitor	£18.50
ROM Exp Board - 4 Slot	£20.00
Vigien Sideways System	£19.95
Computer Desk + Mains Dist.	£55.00
BBKEY. Function Key Mask	£1.50
Flow Chart Template	£1.50
Datapan with software	£25.00
Computer Desk double width	£55.00
Mains distribution block with plugs	£7.50
LVL Modem	£225.00
Sideways ROM Board	£45.00
Torch Z80 Card	£340.00
Disc Storage Box (35)	£16.00
Disc Storage Box (85)	£20.00
Printer Dust Covers	£5.00
Eprommer APTL	£138.00
Power Cleaner Plug	£13.00

PRINTERS

Epson RX80T	£240.00
Epson RX80FT	£280.00
Epson FX80	£370.00
Epson FX100	£560.00
Silver Reed EX500 Daisy Wheel	£340.00
Silver Reed EX43 Typewriter + Interface	£399.00
Nec PC 8023	£225.00
Cannon PW 1080A	£330.00
Tally MT80	£215.00
2000 sheets 9 1/2 in Fanfold Paper	£14.00
Brother HR-5 Printer	£155.00
Epson Serial (2K) Interface	£25.00

MONITORS CTV

Microvitec 14" colour	£230.00
Microvitec 14" Medium Res	£335.00
Microvitec 14" High Res	£460.00
Sanyo 14" colour	£240.00
Sanyo 12" Green High Res	£120.00
Sanyo 12" green	£90.00
Sony 14" CTV with RF input	£229.00
Ferguson 14" Colour Monitor	P.O.A.
SABA 14" CTV REM + RGB	£245.00

UTILITIES/SOFTWARE

View Wordprocessor ROM	£55.00
View Sheet ROM	55.00
Wordwise	
Wordprocessor ROM	£40.00
Disc Doctor ROM	£29.00
Graphics ROM	£29.00
Bee Bug Tool Kit ROM	£27.00
Bee Bug Exmon ROM	£27.00
Bee Bug Masterfile DISC	£19.00
Clares Replica II DISC	£12.00
Clares B. Base DISC	£23.00
BBC Ultracalc ROM	£70.00
BBC Tool Box CASS	£21.00
BBC Beyond Basic CASS	£11.00
BBC Typing Tutor CASS	£15.00
BBC Record Keeper CASS	£13.50
BBC Home Finance CASS	£9.50
Gemini Database 24K ROM	£129.95
BCPL ROM + DISC + Manual	£95.00
Logo ROM (LCSI)	£65.00
ADE ROM	£160.00

BBC SOFTWARE

White Knight Chess	£11.95
Dr Who	£9.95
Home Finance	£9.95
Early Learning	£9.95
Music	£9.95
Computer Program 1	£9.95
Computer Program 2	£9.95
Painting	£9.95
Drawing	£9.95
Canyon	£9.95
Tax Calc	£17.00

GEMINI

Cash Book Acc.	£95.00
Beeb Calc	£19.95
Inv. & Statements	Add £19.95
Commercial Acc.	£4.00 £19.95
Mailing List	for £19.95
Database	disk £19.95
Stock Control	version £19.95
Home Accounts	£19.95
Word Processor	£19.95
Liberator	£9.95
Missile Control	£9.95

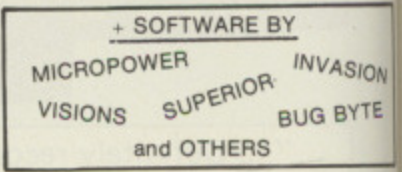

BOOKS FOR YOUR BBC MICRO

30 Hour Basic - BBC/NEC	£6.95
Beyond Basic - BBC/NEC	£7.25
Creative Graphics - Acornsoft	£7.50
Graphs and Charts - Acornsoft	£7.50
Advanced User Guide	£12.95
Forth Manual - Acornsoft	£7.50
Lisp Manual - Acornsoft	£7.50
BCPL User Guide - Acornsoft	£15.00
Assembly Language Programing for BBC - Birnbaum	£8.95
Advanced 6502 Programing - Zaks	£10.25
6502 Applications - Zaks	£9.75
6502 Assy. Language Sub Routines - Leventhal	£14.25
6502 Assy. Language Programing - Leventhal	£12.95
Basic for Business - Hergert	£10.95
Starting Forth - Brodie	£15.25
Introduction to Forth - Knecht	£9.30
Z80 Applications - Coffron	£11.95
Programing the Z80 - Zaks	£13.95
Basic Programing for the Electron - Cryer	£6.95
Electron Assembly Language - Smith	£7.95
Electron Programing for Education - Hall	£5.95
Graphic Art for the Electron - Allan	£5.95
The Electron Book - McGregor	£7.95

*E For ELECTRON PLEASE STATE VAT FREE EXPORT SERVICE
FAST MAIL SERVICE - SAME DAY DESPATCH ON ITEMS IN STOCK

MAIL ORDER COUPON

Please send me:

1 _____ 4 _____

2 _____ 5 _____

3 _____ 6 _____

I enclose cheque / P.O. for _____ P&P see below

Or please debit my Access/Barclaycard/Visa* (delete as applicable)

Card Number _____ Expiry date _____

Name _____

Address _____

Telephone _____

P&H ELECTRONICS LIMITED
22/24 Guildford Road, Bagshot, Surrey GU19 5JN

CARRIAGE COSTS - Micro's, Monitors, Disc Drives, Printers £7
Books, Cassette Decks, Leads, Software 50p each item.

ACCESS, BARCLAYCARD VISA ORDERS WELCOME

CREDIT FACILITIES Instant credit up to £1,000, deposit 10%

Part II of PETER JOHNSON's
examination of the extra
instruction set available
on the second processor

Simpler way to preserve the registers

LAST month we looked at part of the enhanced instruction set to be found on the 65C02 – the chip at the heart of Acorn's 6502 second processor. This month we shall complete our survey.

Group 5

This group is small, containing just two instructions. These were also curious omissions from the original 6502 instruction set – the ability to increment and decrement the accumulator.

It is very difficult to use A as a counter on the standard processor, as the sequence to increment it is:

6502		6502
CLC	or	TAX
ADC#1		INX
		TXA

Both sequences are three bytes long, and the second version has the undesirable side effect of altering X. Even the first version affects the carry flag, which may not be wanted.

Similar sequences are needed to decrement the accumulator. The INC A and DEC A (sometime written INA and DEA) instructions do the job in one byte, with the only side effects being the desirable changing of the sign and zero flags.

Group 6

When a routine must preserve registers, a common way to do it is to put them on the stack. This is especially true in interrupt routines, which

shouldn't alter fixed memory locations unless they are updating a specific item such as the system clock.

A common sequence in the MOS is:

6502	
PHA	Save A
TYA	Save Y
PHA	
TXA	Save X
PHA	
.....	
PLA	Restore X
TAX	
PLA	Restore Y
TAY	
PLA	Restore A
RTS	

All of this just to preserve the registers! On the 65C02, this may be rewritten:

65C02
PHA
PHY
PHX
.....
PLX
PLY
PLA
RTS

Not only is this much shorter, it is also easier to read (and therefore check). The PHX and PHY instructions push

SECOND PROCESSOR

SOFTWARE, FIRMWARE AND HARDWARE FOR YOUR BBC

Buy direct through Prestel (Page *2582020) using your Access

Most programs available on Micronet *60043703

105	MAILING	Holds 218 addresses. Alpha & Post code sorts. searches, any label format, delete, add and amend	£11.95	B
201	GAMES 1	5 Card, Minefield, Darts, Pontoon & Mrmidon	£5.95	B/E
202	STOCKMARKET	Exciting world of Stocks and shares. 1-4 players	£5.95	B/E
301	HANGMAN	Word game in English, French, German, Italian, Spanish	£7.95	B
302	DISTANCES	Three graphic maps of U.K., EUROPE & the WORLD. Calculate the distance between any 2 places	£4.95	B/E
303	FLAGS	98 full colour flags of the world with questions	£4.95	B/E
304	STATPACK	Statistics package giving over 30 results	£9.95	B
305	GRAPH	Produce varied graphs & charts of functions	£7.95	B
306	FRENCH	A New audio visual computer way to learn a language	£7.95	B
307	SPELL-CHECK	Add to WORDWISE. 15000 words in 12 dictionaries ideal in education	£17.95	B
504	PROCAID	includes SEARCHBAS to search a BASIC program and alter it. PROCVAR to list variables in a BASIC program & PROCFLUSH to clear resident integers in RAM	£3.45	A/B
505	UTILITY-A	Our best selling tape includes PROCAID, DEFCHAR to design & display graphic characters, SORTM/C a very fast machine code numeric sort, SORTBAS the undisputed fastest BASIC sort routine	£5.95	A/B
520	BANNER	Print giant text and graphics on paper for displays	£3.95	A/B
521	BIGLETR	Print as above on screen/paper with screen dump	£5.95	A/B
600	FORTH	'79 FORTH second language ROM	£34.74	B
601	LOGO-FORTH	Advanced Turtle Graphics Language ROM with FORTH	£57.50	B
602	PASCAL-T	Structured language ROM with compiler- interpreter	£57.50	R
603	XCAL	Computer Assisted Learning ROM for presentations	£65.00	B
605	WORDWISE	Super fast & easy to use wordprocessor in ROM	£33.95	B
606	CDUMP	Screen dump, 8 colours, suitable for GP700A	£12.95	B
607	GDUMP	Screen dump ROM. 8 shades, 8 sizes and windows	£17.95	B
608	GRAPHICS	NEW ROM for Sprites, LOGO, circles, etc	£27.50	B
700	BOOKS	Various titles for the BBC Micro from	£6.95	
801	CASSETTES	C15 Computer quality tapes packed in 10's	£4.50	
810	5.25" DISCS	MEMOREX. SS/SD 40/80T £19.95 SS/DD 40/80T	£20.95	
901	EPSON RX-80T/F	Superb. 100cps with Tractor & Friction feed	£275.00	
902	EPSON FX-80	Magnificent. 180cps, 6 founts, graphics, F/T Roll	£365.00	
910	DISC DRIVES	Slimline 3" or 5 1/4" 100K-800K Japanese Format disc, cable and excellent manual. Plus £50 of FREE Software	£369.00	
915	DISC UPGRADE	Double or Single Density available in one system	£89.00	
920	VDU STAND	Stainless Support protects your micro	£19.95	
930	GREEN VDU	12" Green Monitor, cream sloping front case	£79.95	
931	COLOUR VDU	JVC 14" Colour Monitor 370 x 470 pixels	£179.95	

ADD VAT TO ALL PRICES EXCEPT BOOKS

Add £1.75 for programs on 40 or 80 Track Disc. No post charge in UK. Send for our free brochure for more information before parting with your money.

memo-calc

107 MEMO-CALC £12.95 B C/D
"IT MUST BE AMONG THE LEAST EXPENSIVE PIECES OF USEFUL SOFTWARE YOU WILL EVER BUY" Revue by Practical Computing July 1983.

Database/calcsheet program which allows up to 255 columns. The number of rows is automatically set from 5 to over 1000 depending on the columns declared. Both numeric and alphanumeric data can be stored in any cell and can be of any length up to 255 characters.

There are a multitude of uses for this program from accounts to diaries, club or personnel records etc. and is probably the one program that we all need. MODE7

107a Manual for MEMO-CALC included free otherwise £2.00 (0% VAT)

PAYROLL

Part 1 is a BASIC program running in MODE7 which accepts new data on employees, allows additions, deletions and alterations, listing of P35 & automatic alterations to the codes as required by tax notice P7X. Fully 'user friendly' with colour and graphics to make life simple for the operator.

Part 2 (WEEKLY) or Part 3 (MONTHLY) is designed to handle the calculations of wages and N.I. It allows for standard pay, two overtime rates, optional pension funds (monthly only) other pay, holiday pay, bonuses, post-tax adjustments and no pay.

106b COIN ANALYSIS £4.95 B C/D EXTRA
106c PENSION £4.95 B C/D EXTRA
106d PAYSLIP FORMS £20.34 per 1000 EXTRA

Buy direct on Prestel No. * 25821534.

PRESTEL MODEM £78.00
PRINTER £120.00 + VAT
IDEAL FOR FARM-LINK

Most Programs Now Available For MSX BASIC Dealer Enquiries Welcome

MICRO

ORGANISATION AT YOUR FINGERTIPS!

We are pleased to offer you a wide range of products primarily for the BBC microcomputer software, firmware and hardware for your computer system.

SEIKOSHA PRINTERS From £120-£369

A new range of printers (Spectrum Compatible) replacing existing models.



CASHBOOK

102 CASHBOOK £11.95 B C/D
FIRST CHOICE This is a double entry cashbook program showing cash and bank credits and debits. i.e. 4 columns. Any number of individual accounts can be used and analysed or totalled individually or cumulatively by associated group. A friendly but very practical, and reliable program which despite its low cost is used by many people in a range of situations from domestic and clubs to schools and businesses. MODE7

102d CASHBOOK £19.95 B D
SECOND CHOICE This version of the above program uses random access disc files and can hold up to 1250 entries on 100K discs and up to 2500 on 200K discs. There is sophisticated protection against unauthorised use built in. MODE 7

102f ACCOUNT £29.95 B D
THIRD CHOICE This version of the above program uses random access disc files and can hold up to 1100 entries on 100K discs, and up to 2250 on 200K discs. Included is a choice of CASH/BANK or VAT/BANK headings. Over 830000 possible accounts combinations. Ledger sheets and summaries can be printed as well as full accounts. The latest balance is available at any time. This program is only available on disc. MODE 7

BUDGET £9.95 + VAT

BUDGET can be used by anybody in a domestic environment to help them with their own budget, by clubs charities wishing to prepare applications for grants and for submission to committees, by educationalists in classrooms to show students where money comes from and how easily it disappears. Available on cassette for the ELECTRON and cassette or disc for the BBC Micro using any operating system.

CRIBBAGE £7.95 + VAT

Cribbage is played with a full pack of 52 cards. An ace always counts as '1'; a Jack, Queen or King counts as '10' when its value is added to others but ranks in normal sequence when scoring runs. There are usually two players, and the most common forms of the game are the five-card and six-card. The winner of the game is the first to score 61 or 121 respectively.

Stop Press ***

RANDOM MAILING up to 1850 addresses, names, phone numbers & codes on one disc. Selective printing any number of labels, repeat, stationery or fan fold. Automatic WORDWISE letters produced repeatedly with personalised names many other features such as automatic sorting by company or personal names. By far the best and most comprehensive program of its type for the BBC Micro Price £29.95 + VAT

Micro-Aid

25 Fore St. Praze, Camborne Cornwall. TR14 0JX tel: 0209 831274

From Page 135

the X and Y registers on the stack, and PLX and PLY pull them back again.

Note that it is now possible to swap the contents of any pair from A, X and Y without affecting the other register or fixed memory locations.

For example, to swap X and Y, the sequence:

```
6502/65C02
STX tmp1
STY tmp2
LDX tmp2
LDY tmp1
```

could be used. This takes four bytes and 14 cycles, as opposed to:

```
65C02
PHY
PHX
PLY
PLX
```

which takes eight bytes and 12 cycles if the temporaries are in zero page, or 12 bytes and 16 cycles if they aren't.

Group 7

The only instruction in this group is JMP (abs,X). This is a totally new addressing mode added to an existing instruction.

To understand it, it is best to consider the normal 6502 instruction JMP (abs).

It takes a two byte address as the operand. At this address and the one after is the two byte address of the destination. For example, in the MOS, the OSWRCH routine contains the instruction:

```
6502
JMP (&20E)
```

This tells the computer to jump to the address held at &20E and &20F. The use of the indirect jump in this case is to enable the address of the final routine to be changed, by altering the contents of &20E and &20F.

This is essential for implementing filing systems on the BBC Micro, and provides the machine with an unequalled flexibility among low-priced machines.

Another use of JMP (abs) is to provide a jump table facility. This is roughly analogous to the

ON...GOTO statement in Basic.

Consider a problem where it is necessary to jump to one of 10 routines depending on the contents of the accumulator. If it is zero, jump to the first routine. If it is one, jump to the second routine, and so on.

A common way of implementing this is:

```
6502
ASL A           Multiply A by 2
TAX            Index jump table
              with X
LDA table,X    Get low byte
              of address

STA temp
LDA table+1,X  Get high byte
STA temp+1
JMP (temp)     Jump to that
              address

.table        First
EQUW lab1     address
EQUW lab2
.....
EQUW lab10    Last address

.lab1 \Routine for A=0
.lab2 \Routine for A=1
.....
.lab10 \Routine for A=9
```

Basically the code looks up an address from a table formed with the EQUWs, and jumps to that address. The accumulator has to be multiplied by two, as each entry in the table is two bytes long.

The rather complex code used above may be simplified by using the 65C02's JMP (abs,X) instruction. It is different from the JMP (abs) because instead of jumping to the address held at the address given by the operand JMP (abs,X) adds X to the operand first and jumps to the address held there.

The new version of the jump table routine is:

```
65C02
ASL A           Still need to double A
TAX
JMP (table,X)
.table         and so on,
EQUW lab1     as above
```

This cuts the jump code down from

Mnemonic	Operation	NVZC	Opcode	Bytes	Cycles
Group 5					
INC A	A=A+1	N.Z.	&1A	1	2
DEC A	A=A-1	N.Z.	&3A	1	2
Group 6					
PHY	Stk=Y Sp=Sp-1	&5A	1	3
PHX	Stk=X Sp=Sp-1	&DA	1	3
PLY	Sp=Sp+1 Y=Stk	&7A	1	4
PLX	Sp=Sp+1 X=Stk	&FA	1	4
Group 7					
JMP (abs,X)	PC=M	&7C	3	6
Group 8					
TSB zp	M=A OR M	N.Z.	&04	2	5
TSB abs	M=A OR M	N.Z.	&0C	3	6
TRB zp	M=~A AND M	N.Z.	&14	2	5
TRB abs	M=~A AND M	N.Z.	&1C	3	6

M is the memory location addressed by the operand
X and Y are the 65C02 registers
Sp is the 65C02 stack pointer
Stk is the address &100+Sp
~A means NOT A, ~C means NOT (the carry flag)
NVZC means that flag is affected, . means it isn't
7 means N is set to bit 7 the operand
6 means V is set to bit 6 of the operand

From Page 137

17 to 5 bytes, and from 25 to 10 cycles. Considering that such a routine may be central to the operation of a language such as Basic or Forth, it can be seen that the new instruction can have a profound effect on the execution speed of programs.

The bug in the 6502's JMP (abs) instruction, whereby a jump indirected across a page boundary went to the wrong address, has been corrected.

Group 8

The test and set bits and test and reset bits instructions are related to BIT, but are probably more useful. Both instruction types may be used with zero page and absolute addressing modes. Unfortunately there are no indexed TSB/TRB instructions.

The operation of TSB is as follows: OR the operand with the accumulator and store the result in the operand address. The Z and N flags are set to

reflect the result of the OR but the accumulator is not affected.

Put another way, TSB sets the bits of operand which are set in the accumulator and leaves the other bits unaltered.

The two sequences below have similar effects:

6502	65C02
LDA addr	LDA#&A5
ORA#&A5	TSB addr
STA addr	

The flags and contents of *addr* are identical after both sequences, though the contents of the accumulator are different.

The TRB instruction has the opposite effect to TSB. The operand is ANDed with NOT (the accumulator), and the result stored back in the operand. Again, the flags are set with respect to the result and the accumulator is unaltered.

It can be seen that after a TRB the bits in the accumulator that are 1 are set

to zero in operand, and the other bits are unaltered.

These two are equivalent:

6502	65C02
LDA mask	LDA mask
EOR#&FF	TRB addr
AND addr	
STA addr	

For example, to set the bottom half of the operand byte to zero, the two sequences:

6502	65C02
LDA addr	LDA#&0F
AND#&F0	TRB addr
STA addr	

would be used.

● Next month we'll look at ways of implementing the enhanced features of the 65C02 using the HiBasic assembler.

Disks, Components and Connectors.

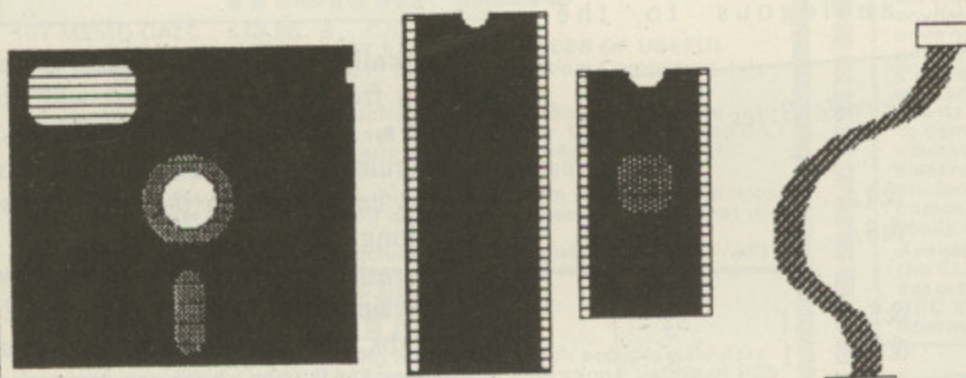

**For All your needs
Call C-TECH,
061-366-8223
061-366-7794
and get our latest
price.**

**MAIL ORDER
NO RISK
SAVINGS**

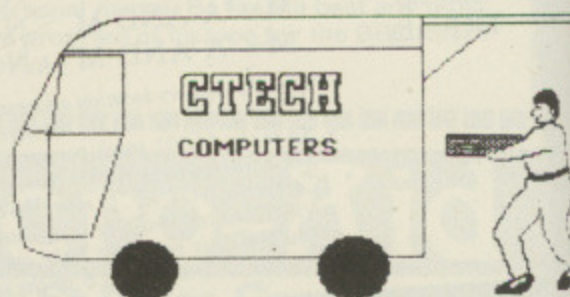

IC's	Price	Floppy Diskettes				
ITEM	<10/10+	ITEM	10	<50	<100	<500
27128	22.95/18.95	BASF SS/DD 96Tpi	13.00	12.50	12.35	11.95
8271	59.00/57.50	BASF DS/DD 96Tpi	22.50	21.95	20.50	19.50
6164	28.50/26.95	Xidex DS/DD 96Tpi	14.95	14.75	14.50	13.95
6116	6.05/5.50	Xidex DS/QD 96Tpi	21.50	20.50	19.60	18.95
4816	8.00/7.50					
6502A	5.50/4.70					
6522	3.95/2.95					
1771	23.00					
2764	6.04/5.85					

Call us Now for Fast delivery,
C-TECH Computers, 184 Market St. Hyde, Cheshire
061-366-8223/7794
All prices Plus VAT



BBC Microcomputer in the NORTH

CTECH Computers Telephone: 061-366-8223/7794

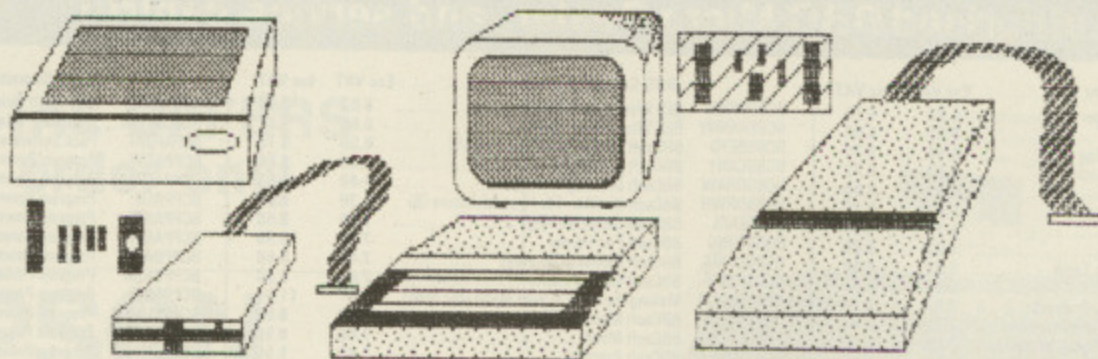

Computers	£ p
BBC Model B	346.95
BBC Model B with DFS	407.82
BBC Model B with DFS & Econet	439.00
BBC Model B with DFS & Wordwise	433.92

Acorn Equipment	£ p
6502 2nd Processor	173.04
Z80A 2nd Processor	260.00
Teletext Adaptor	199.00
Electron Computer	173.04

All computers come with Free Cassette Lead and Software Package. Most add-ons include Free Fitting and installation.

Monitors	£ p
Philips Hi Res	68.69
Microvitec Normal Res	199.00
Ferguson TX-90 RGB/TV	199.00

Light Pens and Joysticks	£ p
Add on Light Pen	21.70
JMB Full Analogue Joystick	13.00
Joystick Pairs	17.35
Hi-Fi Extension Cable	5.17
Atari type joystick to BBC interface	

Components and Cables	£ p
We stock everything e.g.:	
2764 Eproms	6.04
27128 Eproms	LOW
8271 Eproms	POA
Printer Cables	12.99
Disk Power Cables	3.65

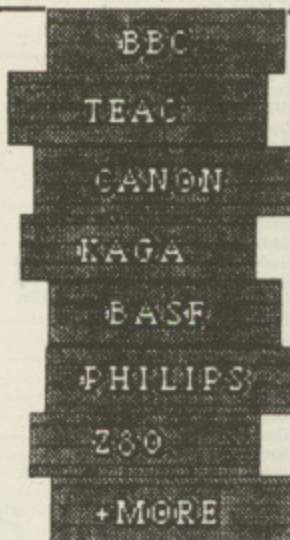

Addons	£ p
ATPL ROM/RAM board	38.00
Light Pen	21.69
OEL 200 Prestel Terminal	87.39
Acorn Speech Synth	47.83
Chip Chat Speech Synth	26.04
Pace Grapevine	POA
Disks	POA

ROM Software	£ p
Wordwise	34.74
Graphics ROM	28.65
Print Master	28.65
View 2.1	52.09
Ultra-Calc	56.48
1.2 O.S.	7.38
Disk Doctor	28.65
BCPL	86.09
Termi	28.65
Commstar	30.39

DISK DRIVES FROM £95.00 + VAT. TEC DRIVES FROM £109 + VAT.
 Bare CHINON FO51D, Slimline, 40 Track, Single Sided. 100K (200K Double Density). As above but complete with Cables, Utility Disk, Cables, Case and Manual. **£109.00 + VAT**
 Bare TEAC55F, Slimline, 40/80 Track, Double Sided 400K (800K at Double Density). **£169.00 + VAT**
 As above but complete with Cables, Utility Disk, Cables, Case and Manual. **£199.00 + VAT.** Call for details.

DUAL DRIVES FROM £199 + VAT
 Dual CHINON FO51D, Slimline, 40 Track, Single Sided 2 x 100K (2 x 200K Double Density). Complete with Cables, Utility Disk, Cables, Case and Manual. **£369 + VAT**
 Dual TEAC 55F, Slimline, 40/80 Track, Double Sided. 2 x 400K (2 x 800K with Double Density). Complete with Cables, Utility Disk, Cables, Case and Manual. (With your drive you may need an interface). **£389 + VAT.**

DISK INTERFACES FROM £69.00 + VAT
 The Fabulous LVL Single and Double Density Interface. This will allow you to read and write to Acorn Disks see below. But also you can create your own Single OR Double Density Diskettes for extra online storage. Maximum capacity is 1.6 MB with 8 logical drives and 248 files. The standard Acorn Interface is available from us this uses the 8271 disk controller which gives very fast access to disk files. Acorn DFS is the standard for the BBC Micro it allows 31 files per disk and a maximum of 800K on 4 logical drives. **£85.00 + VAT**

PRINTERS
 NEC dot matrix printer bi-directional 120 cps. Tractor and friction feed **£199 + VAT**
 QUEN data dotmatrix printer British assembled **£173.04 + VAT**
 CANON PW 1080A. This is the latest state of the art in printer technology. This machine out performs the EPSON FX80. It will do everything the FX80 does and more besides and using the same control codes! What makes the PW1080A so special is not only it's superb value for money but the Near LETTER QUALITY mode. We include a free screen dump and our BBC Micro Instructions as well as the excellent manual. **£259 + VAT.**
 QUEN 5100 Daisywheel. This British assembled printer has all the features that you would expect like Auto Bold, Auto Underline, Sheet Feeder option. Take Qume daisywheels and Ribbons. 20Cps Bi Directional. **£299 + VAT**

PRICES...

All our prices are constantly moving, so please ring us to check the latest price.

All prices Plus VAT

FREE DELIVERY TODAY

(Orders over £90)

Ask about our installation service

If you are in Greater Manchester, Cheshire, Lancashire, Merseyside, Midlands, West Yorkshire or South Yorkshire, if you ring us now we can send one of our highly trained staff to install your computer equipment Today. (Now for Business software too!)

C ★ TECH
COMPUTERS

**184 Market Street,
Hyde, Cheshire
SK14 1EX
061-366 7794
061-366 8223**

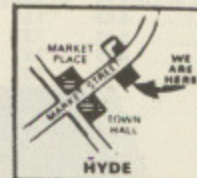

Electronequip

(Authorised BBC Micro Dealer, and service centre)

BBC Cassette Software			BBC Cassette Software			BBC Cassette Software					
	Exc VAT	Inc VAT		Exc VAT	Inc VAT		Exc VAT	Inc VAT			
BCADFOOT	Addictive Football Manager	5.87	6.75	BCBEWORH	BES Wordhang (XBE02)	6.63	7.62	BCMSQUIC	Mirrorsoft Quick Thinking (B)	5.13	5.91
BCAFBOUN	A & F Software Bouncer	5.92	6.80	BCBEWORW	BES World-Wise (XBE01)	6.63	7.62	BCOCMRWI	Ocean Mr. Wimpy	5.10	5.88
BCAFCHIC	A & F Software Chuckie Egg	5.84	6.72	BCBSBEYO	BBCsoft Beyond Basic Cassette (B)	8.50	9.78	BCPAFORT	Pace Software Fortress	6.61	7.60
BCAFCYLO	A & F Software Cylon Attack	5.84	6.72	BCBSCANY	BBCsoft Canyon (B)	7.39	8.50	BCPPADVE	Program Power Adventure (B)	5.87	6.75
BCAFFROG	A & F Software Frogger	5.92	6.80	BCBSDRAW	BBCsoft Drawing	7.40	8.50	BCPPALID	Program Power Alien Destroyers (Invader)	5.91	6.79
BCAFHRR	A & F Software Horror Castle	5.92	6.80	BCBSDRWH	BBCsoft Dr Who: The First Adventure (B)	7.39	8.50	BCPPALIE	Program Power Alien Swirl	5.13	5.91
BCAFHWS	A & F Software Howzat	5.10	5.87	BCBSEARL	BBCsoft Early Learning	7.40	8.50	BCPPASTE	Program Power Asteroid Storm (B)	5.87	6.75
BCAFPAIN	A & F Software Painter	5.92	6.80	BCBSFUNG	BBCsoft Fun Games	7.40	8.50	BCPPASTR	Program Power Astro Navigator	4.21	4.99
BCAFPAPH	A & F Software Pharaohs Tomb	5.92	6.80	BCBSGAMS	BBCsoft Games of Strategy	7.40	8.50	BCPPBAND	Program Power Bandits at 3 o'clock	5.14	5.92
BCAFPAN	A & F Software Pharaohs Tomb	5.92	6.80	BCBSHOMF	BBCsoft Home Finance	7.40	8.50	BCPPBARR	Program Power Barrage for BBC	5.13	5.91
BCAFPAN	A & F Software Pharaohs Tomb	5.92	6.80	BCBSMAKM	Making the most of your Micro (Inc book)	9.57	11.01	BCPPBEEB	Program Power Beeb-Tote (B)	4.40	5.18
BCAFPAN	A & F Software Pharaohs Tomb	5.92	6.80	BCBSMOTO	BBCsoft Motorists' Log	7.40	8.50	BCPPBUMB	Program Power Bumble Bee (B)	5.87	6.75
BCAFSHRI	A & F Software Shrinking Professor	5.92	6.80	BCBSMUSI	BBCsoft Music	7.40	8.50	BCPPCAVA	Program Power Caveman Adventure	5.06	5.84
BCAIAADVE	Adventure International Adventureland	7.35	8.46	BCBSPAIN	BBCsoft Painting	7.40	8.50	BCPPCH16	Program Power BBC Chess (16K)	3.66	4.21
BCAIPIRA	Adventure International Pirate Adventure	7.35	8.46	BCBSPRO1	BBCsoft Programs Vol 1	7.40	8.50	BCPPCHEM	Program Power Chemistry	5.13	5.91
BCAISECR	Adventure International Secret Mission	7.35	8.46	BCBSPRO2	BBCsoft Programs Vol 2	7.40	8.50	BCPPCHES	Program Power Chess	5.87	6.75
BCAIVOOD	Adventure International Voodoo Castle	7.35	8.46	BCBSRECO	BBCsoft Record Keeper (B)	10.20	11.73	BCPPCONS	Program Power Constellation	5.87	6.75
BCAKCHIL	ASK Children from Space (XBE16)	7.35	8.46	BCBSTAXC	BBCsoft Taxcalc (B)	8.16	9.38	BCPPCOSM	Program Power Cosmic Combat (B)	5.14	5.92
BCAKCRAN	ASK Cranky (XBE17)	7.35	8.46	BCBSTOOL	BBCsoft Tool Box (B)	15.52	17.85	BCPPCOWB	Program Power Cowboy Shoot-out	5.06	5.84
BCAKFACE	ASK Facemaker (XBE10)	7.35	8.46	BCBSVUTY	BBCsoft VU Type (Typing Tutor) (B)	11.90	13.69	BCPPCROA	Program Power Croaker	5.87	6.75
BCAKHIDE	ASK Hide & Seek (XBE11)	7.35	8.46	BCBSWHIT	BBCsoft White Knight Mark Eleven (B)	8.50	9.78	BCPPCYBE	Program Power Cybertron Mission (B)	5.87	6.75
BCAKLETS	ASK Let's Count (XBE12)	7.35	8.46	BCBUTWIN	Bug-Byte Twin Kingdom Valley	7.02	8.07	BCPPDAAG	Program Power Danger! UKB	5.87	6.75
BCAKNUMC	ASK Number Chaser (XBE15)	7.35	8.46	BCCCANDR	Computer Concepts Android Attack	6.61	7.60	BCPPDAMD	Program Power Demon Decorator (Painter)	5.06	5.84
BCAKNUMG	ASK Number Gulper (XBR13)	5.82	6.70	BCCCASTE	Computer Concepts Asteroid belt	5.87	6.75	BCPPDIS	Program Power BBC Disassembler	5.06	5.84
BCAKNUMP	ASK Number Puzzler (XBE14)	7.35	8.46	BCCCCHES	Computer Concepts Chess	6.61	7.60	BCPPELDO	Program Power Eldorado Gold (Adventure)	5.06	5.84
BCAKTABL	ASK Table Adventures (XBE18)	7.35	8.46	BCCCGAME	Computer Concepts Games Galore 1	6.61	7.60	BCPPESCA	Program Power Escape from M'base Alpha	5.87	6.75
BCAKWORD	ASK Words, Words, Words (XBE19)	7.35	8.46	BCCCITC	Computer Concepts Hitch Hiker	4.93	5.67	BCPPFFAC	Program Power Felix in the Factory	5.87	6.75
BCALABM	Alligata Software ABM (Laser Command)	4.39	5.05	BCCCLOGO	Computer Concepts Logo II	8.50	9.78	BCPPFFRU	Program Power Felix & the Fruit Monsters	5.87	6.75
BCALBLAG	Alligata Software Blagger	6.61	7.60	BCCCSNAK	Computer Concepts Snake	5.87	6.75	BCPPFOOT	Program Power Footer	5.87	6.75
BCALBUGB	Alligata Software Bug Blaster	5.88	6.76	BCCCSPAC	Computer Concepts Spacehawks	5.87	6.75	BCPPGALA	Program Power Galactic Commander	5.87	6.75
BCALCOSM	Alligata Software Cosmic Asteroids	4.39	5.05	BCCCSWAR	Computer Concepts Swarm	6.61	7.60	BCPPGHOU	Program Power Ghoul	5.87	6.75
BCALDAMB	Alligata Software Dambusters	5.87	6.75	BCDASUPE	DACC Super-7 (Arcade games compend.)	6.61	7.60	BCPPHELL	Program Power Hell Driver (B)	5.87	6.75
BCALEAGL	Alligata Software Eagle Empire	5.87	6.75	BCDS747	Doctor Soft 747	5.87	6.75	BCPPINTE	Program Power Intergalactic Trader (B)	6.61	7.60
BCALFRUI	Alligata Software Fruit Machine (B006)	4.39	5.05	BCFBSPAD	First Byte Space Adventure One	5.87	6.75	BCPPJETP	Program Power Jet Power Jack	5.87	6.75
BCALLUNA	Alligata Software Lunar Rescue (B007)	5.87	6.75	BCFBSTFO	First Byte Star-Force Lander	5.14	5.91	BCPPKILL	Program Power Killer Gorilla	5.87	6.75
BCAMALGE	Ampalsoft Cheshire Cat Algebra D level	5.13	5.90	BCFBSTTR	First Byte Star Trader	5.87	6.75	BCPPLABC	Program Power Labyrinths of la Coshe	5.87	6.75
BCAMARIT	Ampalsoft Cheshire Cat Arithmetic D level	5.13	5.90	BCFBVAPH	First Byte Valley of the Pharaohs	5.87	6.75	BCPPLASE	Program Power Laser Command	5.87	6.75
BCAMCALC	Ampalsoft Cheshire Cat Calculus D level	5.13	5.90	BCGACHEE	Garland Software Chemical Equations	9.57	11.01	BCPPMART	Program Power Martian Attack (B)	5.87	6.75
BCAMCDNS	Ampalsoft Cheshire Cat Construction "O"	5.13	5.90	BCGACHEI	Garland S'ware Chemistry Inorganic Ana	9.57	11.01	BCPPMASM	Program Power Mastermind for BBC	3.36	3.81
BCAMGRAP	Ampalsoft Cheshire Cat Graphs O level	5.13	5.90	BCGACHES	Garland S'ware Chemistry Symbol/For/Va	9.57	11.01	BCPPMAZE	Program Power Maze Invaders (B)	4.40	5.18
BCAMMAT1	Ampalsoft Cheshire Cat Maths "O" level 1	11.05	12.71	BCGAHUMA	Garland S'ware Human Body Heart & Kid.	9.57	11.01	BCPPMINE	Program Power Mine (B)	5.87	6.75
BCAMMAT2	Ampalsoft Cheshire Cat Maths "O" level 2	11.05	12.71	BCGAPHYC	Garland S'ware Physics Cathode Ray Osc	9.57	11.01	BCPPMOON	Program Power Moon Raider	5.87	6.75
BCANTRIG	Ampalsoft Cheshire Cat Trigonometry "O"	5.13	5.90	BCGEBEEB	Gemini Beebcalc (Spreadsheet)	14.75	16.96	BCPPNEME	Program Power Nemesis (B)	5.87	6.75
BCAS100P	Acornsoft 100 Programs for BBC Micro	8.50	9.78	BCGEBEEP	Gemini Beebplot (Graph Plot)	14.75	16.96	BCPPPOKE	Program Power Poker Dice (B)	4.40	5.18
BCASAACT	Acornsoft Arcade Action (SBG06)	8.80	10.12	BCGECASB	Gemini Cash Book Accounts	44.31	50.96	BCPPPOSI	Program Power Positron (B)	5.14	5.92
BCASARCA	Acornsoft Arcadians (SBG14)	7.35	8.46	BCGECATE	Gemini Caterpillar	7.35	8.46	BCPPPREV2	Program Power Reversi (32K)	4.21	4.99
BCASAVIA	Acornsoft Aviator flight simulator SBG02	11.05	12.71	BCGEDATA	Gemini Database	14.75	16.96	BCPPPROU	Program Power Roulette for BBC	4.21	4.99
BCASBUSI	Acornsoft Business Games (SBE03)	7.35	8.46	BCGEEASI	Gemini Easi-Ledger	14.75	16.96	BCPPSEEK	Program Power Seek	5.06	5.84
BCASCARD	Acornsoft Carousel (SBG24)	7.35	8.46	BCGEFINA	Gemini Final Accounts	44.31	50.96	BCPPSPAC	Program Power Space Jailer (B)	5.14	5.92
BCASCASST	Acornsoft Castle of Riddles (SBG17)	7.35	8.46	BCGEFINA	Gemini Final Accounts	44.31	50.96	BCPPSTAR	Program Power Startrek	4.21	4.99
BCASCCHAN	Acornsoft Chemical Analysis (SBE12)	10.20	11.73	BCGEHOMA	Gemini Home Accounts	14.75	16.96	BCPPSWOO	Program Power Starwoop	5.87	6.75
BCASCHESS	Acornsoft Chess (SBG10)	7.35	8.46	BCGEINVS	Gemini Investat (Invoices & Statements)	14.75	16.96	BCPPTIMT	Program Power Timetrek (Startrek Plus)	5.87	6.75
BCASCESI	Acornsoft Chemical Simulations (SBE13)	10.20	11.73	BCGELIBE	Gemini Liberator	7.35	8.46	BCPPWALL	Program Power Wall (B)	4.40	5.18
BCASCST	Acornsoft Chemical Structures (SBE14)	10.20	11.73	BCGEMAIL	Gemini Mail List	14.75	16.96	BCPPWHER	Program Power Where (B)	5.14	5.92
BCASCOLL	Acornsoft/ICL Collectors Cat. SBX05	7.35	8.46	BCGEMISS	Gemini Missile Control	7.35	8.46	BCPPWHIC	Program Power Wich Salt?	5.14	5.92
BCASCOUN	Acornsoft Countdown to Doom (SBG19)	7.35	8.46	BCGEPAYR	Gemini Payroll	29.53	33.96	BCPPWLDG	Program Power World Geography (B)	5.14	5.92
BCASCRAZ	Acornsoft Crazy Tracer (SBG26) (B)	7.35	8.46	BCGESLEI	Gemini Sleighbells	7.35	8.46	BCPPZARM	Program Power Zarm (B)	5.87	6.75
BCASCREA	Acornsoft Creative Graphics (SBX01)	7.35	8.46	BCGESTOC	Gemini Stock Control (ICS)	14.75	16.96	BCPSSALO	Psion Saloon Sally	4.39	5.17
BCASDESK	Acornsoft Desk Diary (SBB01)	7.35	8.46	BCGETRAD	Gemini Traditional Games (B) (E)	11.05	12.71	BCPSVUCA	Psion VU Calc	11.05	12.71
BCASDRAU	Acornsoft Draughts & Reversi (B) (SBG20)	7.35	8.46	BCGEWORD	Gemini Word Processor	14.75	16.96	BSQSBEEB	Quicksilva Beeb Art (B)	11.05	12.71
BCASEXAM	Acornsoft Examiner Cassette (SBE17) (B)	7.35	8.46	BCGGFAIR	Griffin & George Fairshare	7.35	8.46	BCSGENE	Quicksilva Generator (B)	5.13	5.91
BCASFORE	Acornsoft Forecast (SBB02)	8.80	10.12	BCGGGETS	Griffin & George Getset	7.35	8.46	BCOSMUSI	Quicksilva Music Processor (B)	11.05	12.71
BCASFORT	Acornsoft Forth Cassette (SBL01)	12.45	14.32	BCGGNUMB	Griffin & George Numberfun	7.35	8.46	BCRHGALA	RH Software Galactic Wipeout (RHS001C)	6.61	7.60
BCASFREE	Acornsoft Free Fall (SBG28)	7.35	8.46	BCGGTALP	Griffin & George Tablesums	7.35	8.46	BCRHSKIS	RH Software Ski Slalom (RHS002C)	6.61	7.60
BCASFRNE	Acornsoft French (Linkword) (SBX13)	11.05	12.71	BCGGWORG	Griffin & George Wordgames	7.35	8.46	BCSHGBLT	Simon W Hessel GB Ltd	5.13	5.91
BCASGERM	Acornsoft German (Linkword) (SBX16)	11.05	12.71	BCGGWORS	Griffin & George Wordspell	7.35	8.46	BCSHINHE	Simon W Hessel Interitance	4.39	5.17
BCASGRAP	Acornsoft Graphics on the BBC	8.50	9.78	BCGHTALP	Good Houseke'g Mr T's Alphabet	9.57	11.01	BCSHTRAV	Simon W Hessel Travel Game	4.39	5.17
BCASGRAP	Acornsoft Graphs & Charts (SBX02)	7.35	8.46	BCGHTMEA	Good Houseke'g Mr T's Measuring Games	9.57	11.01	BCSI3DBO	Software Invasion 3D Bomb Alley	5.87	6.75
BCASHOOK	Acornsoft/ICL Hooked on Numbers (SBX08)	7.35	8.46	BCGHTNUM	Good Houseke'g Mr T's Number Games	9.57	11.01	BCSIATTA	Software Invasion Attack on Alphacenturi	5.87	6.75
BCASHOPP	Acornsoft Hopper (SBG23)	7.35	8.46	BCGHTSHA	Good Houseke'g Mr T's Shape Game	9.57	11.01	BCSIEAGL	Software Invasion Eagles Wing (B)	5.87	6.75
BCASITAL	Acornsoft Italian (Linkword) (SBX14)	11.05	12.71	BCGHTTLE	Good Houseke'g Mr T's Tells the Time	9.57	11.01	BCSIGUNS	Software Invasion Gunsmoke	5.87	6.75
BCASJARS	Acornsoft Jars (SBE15)	8.83	10.16	BCGRMINE	Graphic Research Minefield	5.13	5.90	BCSISPOO	Software Invasion Spooks & Spiders (B)	5.87	6.75
BCASJCRB	Acornsoft JCB Digger (SBG09)	7.35	8.46	BCGRORBI	Graphic Research Orbit O	7.35	8.46	BCSIVORT	Software Invasion Vortex	5.87	6.75
BCASLISD	Acornsoft Lisp Demo Progs SBL09	7.35	8.46	BCHOADVB	Honeyfold Advanced Basic course	12.10	12.71	BCSMDIS	Simonsoft Disassembler	5.87	6.75
BCASLISP	Acornsoft Lisp Cassette (SBL02)	12.45	14.32	BCHOBEGA	Honeyfold Beginners Assembly Language	12.10	12.71	BCSS2002	Superior Software 2002	5.87	6.75
BCASMAGI	Acornsoft Magic Garden (B) (SBX04)	7.35	8.46	BCHOBEGB	Honeyfold Beginners Basic course	12.10	12.71	BCSSALID	Superior Software Alien Dropout	5.87	6.75
BCASMEMB	Acornsoft/ICL M' ship Manager (SBX06)	7.35	8.46	BCBSPENG	H. Soft Penguin	6.59	7.58	BCSSBATT	Superior Software Battle Tank	5.87	6.75
BCASMETE	Acornsoft Meteors (SBG13)	7.35	8.46	BCBICRIM	Ivan Berg Crime & Detection Quiz (XBX02)	9.35	10.75	BCSSCENT	Superior Software Centipede	5.87	6.75
BCASMICR	Acornsoft Microtext (SBL04)	36.85	42.37	BCIBDATI	Ivan Berg Dating Game (XBX08)	9.35	10.75	BCSSCOLD	Superior Software Colditz Adventure	5.53	6.31
BCASMISB	Acornsoft Missile Base (SBG18)	7.35	8.46	BCIBHIST	Ivan Berg History Quiz (XBX04)	9.35	10.75	BCSSCRAZ	Superior Software Crazy Painter	5.87	6.75
BCASMISB	Acornsoft Missing Signs (SBE09)	8.83	10.16	BCIBIDO	Ivan Berg 'I Do' (XBX07)	9.35	10.75	BCSSCRIB	Superior Software Cribbage	5.13	5.91
BCASMONS	Acornsoft Monsters (SBG03)	7.35	8.46	BCIBMUSI	Ivan Berg Music Quiz (XBX03)	9.35	10.75	BCSSFAIR	Superior Software Fairground	5.87	6.75
BCASNUMB	Acornsoft Number Balance (SBE08)	8.83	10.16	BCIBROYA	Ivan Berg Royalty Quiz (XBX06)	9.35	10.75	BCSSFROG	Superior Software Frogger	5.87	6.75
BCASONET	Acornsoft/ICL One to Nine (SBX07)	7.35	8.46	BCIBSCIE	Ivan Berg Science Fiction Quiz (XBX05)	9.35	10.75	BCSSFRUI	Superior Software Fruit Machine	5.87	6.75
BCASPEEK	Acornsoft Peeko-Computer Pack (SBE02)	7.35	8.46	BCIBTHER	Ivan Berg Theatre Quiz (XBX01)	9.35	10.75	BCSSGALA	Superior Software Galaxians	5.87	6.75
BCASPERS	Acornsoft Personal Money M'ment SBB5	8.80	10.12	BCIJ3DMA	IJK 3D Maze for BBC (7)	3.32	3.82	BCSSHUNC	Superior Software Hunchback	5.87	6.75
BCASPILH	Acornsoft Philosophers Quest (SBG01)	7.35	8.46	BCIJFLAG	IJK Flags for BBC (12)	3.32	3.82	BCSSINVA	Superior Software Invaders	5.87	6.75
BCASPICT	Acornsoft Picture Maker (SBX03)	7.35	8.46	BCIJHYPE	IJK Hyperdrive for BBC (13)	4.80	5.52	BCSSOVER	Superior Software Overdrive	5.87	

Electronequip

(Authorised BBC Micro Dealer, and service centre)

SPECIAL OFFERS Mail order only

*EPSON

RX-80FT £225.25 + VAT

FX-80 £320.88 + VAT

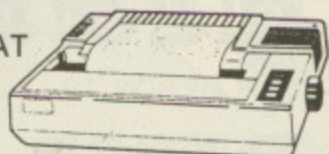

Printer price includes cable for BBC and screen dump rom is available for £11.50

SIDEMISE

SIDEMISE FITTED

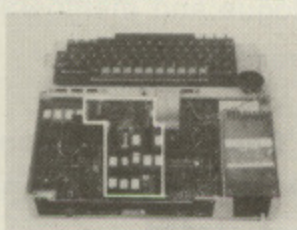
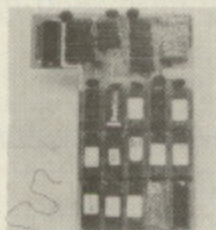

"SIDEMISE" rom board for BBC Micro.
No soldering required £38.00 + VAT

VOLTMACE JOYSTICKS

*10% off list prices



		Discounted price
JSVOLT 14	Voltmace Delta 14B Joysticks	13.46
JSVOLTAD	Voltmace 14B/1 Adaptor Box	13.36
JSVOLT3B	Voltmace Delta 3B Twin Joysticks	18.09

Prices subject to variation without prior notification

TRADE ENQUIRIES WELCOME
Access & Barclaycard Accepted
Large Stocks - 24 Hour Despatch
Carriage 46p



Electronequip is an authorised Acorn service centre and has been an Acorn dealer since the introduction of the Atom. Our demonstration facilities include 20 station Econet and Torchnet systems.

Ref.	BBC Micros	Ex VAT	Inc VAT
ANB01	BBC Model B Micro Computer	348.26	399.00
ANB02	BBC Model B with Econet Interface	389.14	446.00
ANB03	BBC Model B with Disc Interface	409.14	469.00
ANB04	BBC Model B with Disc & Econet Interface	450.01	516.00

3" Micro Disc £89.00
(inc. VAT)

Disc Interface & Drive
£198.95 (inc. VAT)



Micro Disc Drive for the BBC Micro

The Micro disc drive offers a method of low cost quick access to programs. The drive is essentially a small version of a 5¼" disc drive and offers similar features to the larger drive. The data is stored on a 3" disc, this is enclosed in a protective hard plastic cassette which features a write protect switch. The micro drive requires the standard Acorn disc interface, but a new disc filing system rom. Acorn DFS may be exchanged for the micro DFS for £12.00. The new micro disc filing system can read and write to Acorn DFS discs.

Thus if a 5¼ inch and a micro floppy were connected on the same cable files could be transferred between them.
Capacity: 80.64 K bytes **Transfer Rate:** 125k bit/s.

BRANCHES

FAREHAM: 59 WEST STREET (0329) 230670
KINGS LYNN: 17 TENNYSON AVE. (0553) 3782
MAIL ORDER: 36-38 WEST STREET
FAREHAM, HANTS. (0329) 230670



Electronequip

36-38 West Street, Fareham, Hants (0329) 230670



TECHNOMATIC

BBC Computer & Econet Referral Centre
01-208 1177

OCTOBER 84'

ACORN COMPUTER SYSTEMS

BBC Model B Special Offer.....	£320 (a)
BBC Model B + Starter Pack.....	£348 (a)
BBC Model B + DFS.....	£409 (a)
BBC Model B + Econet.....	£389 (a)
BBC Model B + Econet + DFS.....	£450 (a)
BBC Dust Cover.....	£4 (d)
Pair of Joysticks.....	£14.50 (d)

UPGRADE KITS

A to B.....	£85 (d)	Installation.....	£20
ACORN DFS Kit.....	£95 (d)	Installation.....	£15
Econet Kit.....	£42 (d)	Installation.....	£25
Speech Kit.....	£47 (d)	Installation.....	£15

ECONET ACCESSORIES

Terminator (Two reqd per installation)		File Server Level II.....	£216 (c)
.....	£31 (c)	10 Station Lead Set.....	£28 (c)
Clock with psu.....	£35 (c)	Extra Econet cable.....	£1.50/m (d)
Printer Server Rom.....	£42 (c)	Econet User Guide.....	£10 (d)
File Server Level I.....	£86 (c)		

ACORN BITSTICK

The Acorn adaptation of the renowned 'Bitstick' graphic CAD package — the "expensive joystick" that lets you exploit the powerful capability of the BBC micro to the full. The joystick is of a robust design which achieves remarkable precision without fiddliness. Total control is available from the joystick using the on-screen menu. It can draw freehand or follow lines of shapes chosen with high accuracy, and colours can be chosen from a palette displayed on the screen. Any part of a drawing can be magnified, by a virtually unlimited number of times, and upto 48 drawings can be saved on a single disc. The discs use a visual library system for easy identification. In spite of its powerful features, the Bitstick is extremely friendly and easy to use, due to menus being displayed on the edge of the screens.

£328.00 (a) FX80 dump routine for the bitstick available.

TORCH UNICORN PRODUCTS

The TORCH Unicorn system has been in the field for over two years and is now a proven Z80 system for the BBC. It gives you the potential to expand which no other system can currently offer. You can expand a single system with a 20Mb Hard Disc, have the processing power of a 32bit 68000 cpu with 256K ram and a UNIX operating system, or set up a network of upto 254 machines. All these capabilities are available NOW.

The TORCH UNICOMM Modem package is now available for the UNICORN range providing the benefits of the extensive TORCH communication packages. It offers three options: **Uniview** for viewdata services, **Uniterm** for terminal emulation, and **Unimail** which allows messages and files to be exchanged between Unimail/Torchmail/Torchmail-Plus users. Access to files can be controlled by heirarchical passwords which determine the extent of access.

Z80 Card ZEP100 with PERFECT Software Packages
+ Z80 Basic.....£275 (a)
Z80 Disc Pack ZDP240 with software as above.....£875 (a)
20Mb Hard Disc + 1 x 400K Floppy Drive.....£1,950 (a)
UNICOMM Communications Package + modem.....£161 (a)
Unicorn 68000, Unix OS/Z80B/256K, 20MB
Hard Disc, 400K Floppy.....£2995 (a)

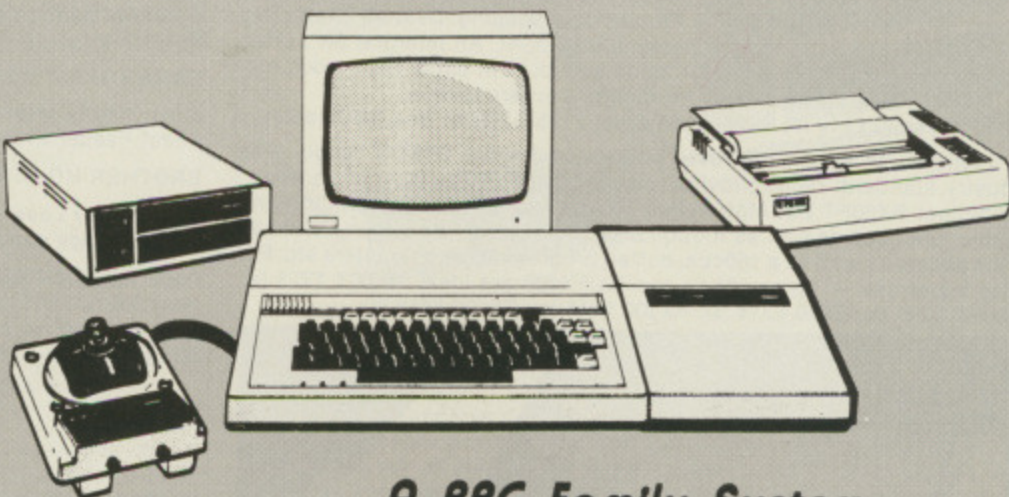
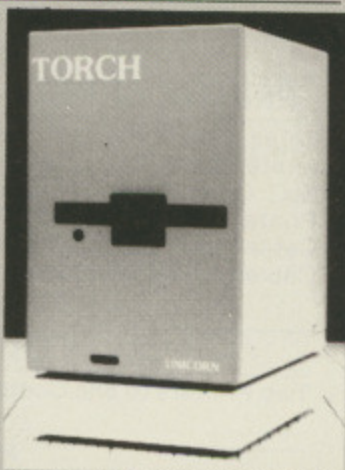

A BBC Family System

ACORN Z80 2nd Processor

This processor converts your BBC into a complete business micro with all the computing power a professional would need. The system is CP/M based and is supplied with a very extensive software package. The package includes three office productivity programs, (memoplan, fileplan and graphplan), Systems generator program, three programming languages plus the ACCOUNTANT business program. Software is accompanied by extensive manuals that not only get you started but also answers your whys and hows.

All for only £299 (a)

ACORN 6502 2nd Processor

This processor is designed for the serious computer user who wants to get even more out of his computer. This processor provides increased memory — allowing up to 44K for Basic programs and up to 60K for assembly language programs, regardless of screen mode in use. (ideal for VIEW). An increase in speed means that programs run up to 50% faster. The second processor/BBC combination offer computing power comparable to systems costing twice as much.

£175 (a)

TORCH GRADUATE SYSTEMS

This latest addition to the range of BBC upgrades will upgrade your BBC to a powerful 16bit business computer and make it disc & hardware compatible with the IBM PC. Its MS/DOS is customised to IBM compatibility allowing access to the massive range of IBM compatible software, programming aids, compilers and languages. It uses A8088 CPU at 5MHz, 128K or 256K ram, single or dual drive, software compatibility allows LOTUS 1-2-3, Flight Simulator and other popular IBM PC business programs to run. Connection of the Graduate is simple, with just a connection to the 1Mhz Bus. The disc drives can be used in both BBC and IBM PC mode without needing an Acorn Disc Interface in the computer. The top-of-the-market GRADUATE Model G800/2 will come complete with the superb Xchange suite of programs, comprising a full feature word processor, a financial planner, a database, and a business graphics package. Although these programs are in modular form, they can be linked together to form an integrated software system that allows you to switch instantly between various tasks and to exchange information between programs. G800/2 £945 (a) Full spec & prices on application.

PRINTERS

ALL PRINTERS HAVE A 12 MONTH GUARANTEE

DOT MATRIX

This month we are adding the new **KAGA** printers to our range of quality dot matrix printers. These printers, with their **EPSON** compatible control codes are available in 80 col & extra wide 156 col versions. Features include NEAR LETTER QUALITY print using a 23 x 18 matrix, Dot addressable graphics in 8, 9 & 16 pin modes. Text modes include Normal, Italic, Enlarged, Condensed, Super & Sub script, Proportional spacing. Defined characters can be placed in ROM to give personalised print. An integral 3K buffer, both friction & adjustable tractor feeds with built in paper roll holder, etc. etc. makes these superb 'value for money' printers unique.

KP810 (80 cols) **£249 (a)** KP910 (156 Cols) **£375 (a)** (With free BBC cable). We continue to supply the ever popular, definitive **EPSON** range. This 'industry standard' range provide reliability and quality 'second to none'. The budget RX80FT Dot Matrix, has 100cps and all standard printing and graphic functions as well as friction and tractor feed. The deluxe FX80 has all the above, as well as a 160cps, buffer, programmable characters etc. For wider paper use — up to 16" — the RX/FX100 are ideal. RX80T **£225 (a)**; RX80FT **£240 (a)**; FX80 **£318 (a)**; RX100 **£345 (a)**; FX100 **£450 (a)**.

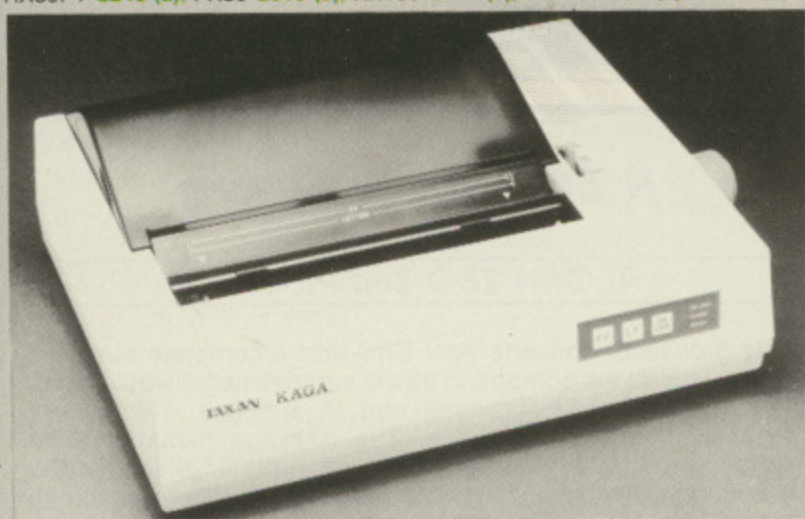

DAISY WHEEL

The Brother HR15 daisy wheel offers features normally found in printers costing far more. Features include: 14 cps, 3K buffer, proportional spacing, underlining, bold and shadow printing, two colour printing, super & subscript and many other features. Centronics parallel interface is fitted as standard.

BROTHER HR15 **£349 (a)** (With free BBC Cable).

The JUKI 6100 daisywheel with 20cps, 2K buffer, and switchable 10, 12, 15cpi + proportional printing. A linear motor ensures optimum reliability. JUKI 6100 **£345 (a)**

GRAPHICS PLOTTER/WORK STATION

Equally at home in the artists studio, hobbyists workshop, science lab or a classroom, this system has something to offer for everyone. The 3 colour graphics plotter provides both precision and versatility. The carriage can be moved with an accuracy of 0.025cm over an A4 area — the plotter being able to accept paper and far thicker materials at sizes of up to A3. The basic plotter carries 3 colour pens each of which is software selectable. Additional accessories greatly enhance the versatility of the unit without losing the accuracy. The servo controlled drill/router, and scribe can be used on various materials. A unique Opto Sensor (using a Hewlett Packard device) turns the plotter into a high-res scanning digitiser to read & store whole diagrams and photographs.

Workstation Complete **£490(a)**; Basic Plotter **£270(a)**; Software on disc **£3.00**; Power Supply: PS12V **£42**; PS24V **£78**; Drill/Router Attachment **£79**; Scribe **£7**; Opto Sensor **£72**

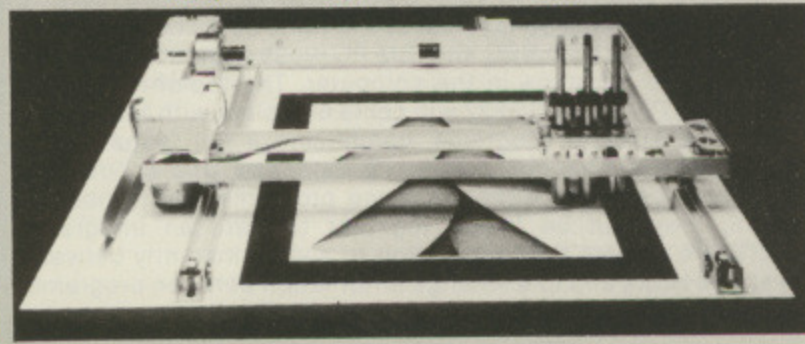

TECHNOMATIC

All prices exclude VAT

PRINTER ACCESSORIES

EPSON

Paper Roll Holder **£17 (d)** FX80 Tractor Attachment **£37 (c)**. Interfaces: 8143 RS232 **£35(c)**; 8148 RS232 + 2K **£55(c)**; 8132 Apple II **£60(c)**; 8165 IEEE + Cable **£65(c)**.

Serial & Parallel Interfaces with larger buffers available. Ribbons: RX/FX/MX80 **£5.00(d)**; RX/FX/MX 100 **£10(d)**; FX80 Dustcover

KAGA TAXAN: RS 232 Interface + 2K buffer £85(c); Ribbon KP810/910 £6(d)

JUKI: RS232 Interface £65(c); Spare Daisy Wheel £14(d); Ribbon £2.50(d) Sheet Feeder £199(a); Tractor Feed Attachment £99(a)

BROTHER HR15: Sheet Feeder £199(a); Ribbons Carbon or Nylon £3(d)

BBC Printer Lead: Parallel (42") £7(a); Serial £7(a)
Printer Leads can be supplied to any other length.

Plain Fanfold Paper with extra fine perforation (Clean Edge):

2000 9.5" x 11" **£13(b)**; 200 15" x 11" **£18.50(b)**

Labels: 2-3/4" x 1-7/16" in quantities of 1000

Single Row: **£5.25/1000 (d)**; Triple Row: **£5.00/1000 (d)**

PRINTER SHARER BUFFER

A unique deluxe printer buffer/sharer providing a simple way to upgrade your computer system by allowing greater utilisation of existing equipment by reducing the waiting time for printing documents. Data from three computers can be loaded into the buffer which will continue accepting data until its 64K storage is full. The buffer will automatically switch from one computer to the next as soon as that computer has dumped all its data. The computer is then available for other uses. A LED bargraph indicates the memory usage, with LED indication showing from which computer the data is being fed from. There is simple push button control for PAUSE, RESET, and COPY facilities. The copy facility is ideal for continually printing copies of a document without 'tying up' the computer. Built in mains psu.

SP110 BUFFER/SHARER incl one cable set **£275(b)**

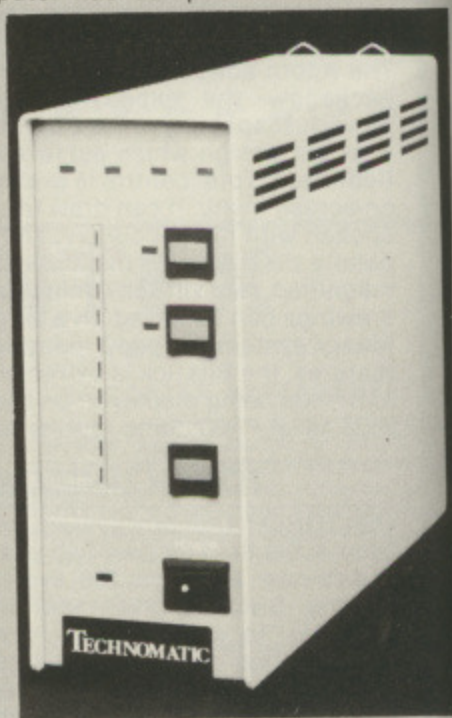

PRINTER SHARER

Three Computers to one printer (parallel).....**£65(b)**

Six Computers to One Printer (parallel).....**£129(b)**

Cables for Three Way Sharer.....**£25(c)**

Cables for Six Way Sharer.....**£38(c)**

COMPUTER SHARER

Two Printers to one Computer.....**£19(c)**

GRAFPAD

A low cost graphic tablet offering the performance & durability required by industrial and educational users. It is compact, accurate & reliable; working area 240 x 192mm + menu area. Comes complete with a CAD packag. **£120 (b)**. 'Microdraw' CAD Package **£21.70 (d)**.

VIEW PRINTER DRIVER FOR FX80/KP810

This driver allows the use of all FX80s fonts to be used in text written using the VIEW rom. If user defined characters are held in the printer buffer they can also be used within the text. Manual includes examples. Supplied on 40 or 80 Track disc.....**£7 (d)**.

A cho
availa
14" mo
resoluti
to 895
availab
availab
1431 S
1451 M
2031 20
Plinth f
The KA
in a sma
The Ja
monito
display
availab

VIDEO

A high qu
uses for t
user. Fee
from a ca
the BBC
with eigh
picture ca
manipula
friendly, y
software
dump. £2

A high c
recordin
and a ta
wanting

The offic
automat
cassette

A sup
sensitiv
tip. Ful
Softwa
comple
circle X
cassett
between
into a
subsec
use of
The 'Ec
be prog

01-208 1177

Please add carriage: (a) £8; (b) £2.50; (c) £1.50; (d) £1.

MONITORS

A choice of high quality RGB and Monochrome monitors are available. The British made **MICROVITEC** Std/Med/Hi Resolution 14" monitors offer a consistent reliable performance. Their resolution ranges from 452 pixels horizontal on the std res monitor to 895 pixels on the Hi res monitor. Std res monitors are also available with RGB/PAL/Audio inputs. Dual input versions also available.

1431 Std. Res. RGB **£175 (a)**; 1431AP RGB/PAL/AUDIO **£225 (a)**;
1451 Med. Res. RGB **£295 (a)**; 1441 Hi-res RGB **£420 (a)**.
2031 20" Std. Res. RGB **£260 (a)**.

Plinth for Microvitec 14" Monitors **£8.50 (c)**.

The **KAGA** Vision 3 12" RGB monitor offers a superb performance but in a smaller cabinet with a genuine etched anti-glare screen. **£358 (d)**. The Japanese made **SANYO** and the **KAGA** monochrome monitors provide an ideal answer for an 80 character hi-clarity display. A futuristic swivel base plinth with integral clock is available for the Kaga green monitor as an optional extra.



KX1201G with stand

SANYO DM 8112CX Hi Res Green Screen.....**£99 (a)**
KAGA KX1201G 20MHz Hi Res Green with etched screen....**£106 (a)**
Swivel Base for Kaga Green (fitted with digital clock).....**£22.50 (c)**
Note: All monitors are supplied with free BBC leads.
BBC Leads: Kaga RGB **£5**;
Microvitec **£3.50**; Monochrome **£3.50 (d)**

VIDEO DIGITISER

A high quality yet cost-effective unit offering uses for the scientific, educational and home user. Feeding in a video signal (this can be from a camera, VCR etc) will output to the BBC a high quality picture, with eight different grey levels. This picture can be stored on disc, manipulated or dumped to a printer. The friendly, yet sophisticated menu driven software comes complete with an Epson printer dump. **£250 (a)**.

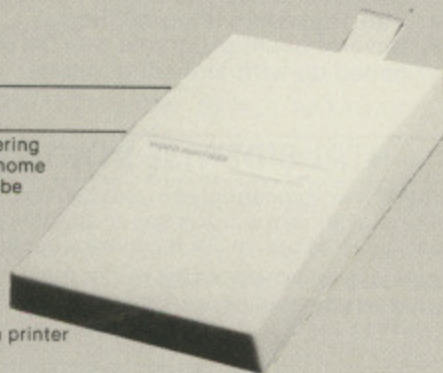

SANYO DR101 DATA RECORDER

A high quality tape recorder with circuitry specifically designed for data recording. Having normal as well as data recording, as well as cue/review and a tape counter, it makes this recorder an ideal choice for anyone wanting a reliable tape storage device. **£30 (c)**. Cassette **£3.00 (d)**.

ACORN ANFO3 TAPE RECORDER

The official Acorn tape recorder recommended for the BBC. Has a counter, automatic record level, mains/battery and comes complete with a BBC cassette cable.....**£28.50 (c)**.

RH LIGHTPEN

A superior quality lightpen, features including: adjustable sensitivity, LED output to show data transmission, microswitch tip. Full software backup. **£39 (c)**. The 'Lightpen Colour Graphic Software' pack helps you to draw line drawings as well as more complex drawings. Colour fill, point plotting, line, square, triangle, circle XY rulers are all available with rubber banding facility. **£7 cassette, £9 Disc**. The 'Artfun' pack provides full interaction between pen and screen. Allows your initial design to be shrunk into a high res format, and these images can be stored for subsequent use. **£7 cassette**. The 'Word Master' encourages the use of correct grammar and is an excellent aid. **£7 on cassette**. The 'Ed Master' uses a quiz format, and up to 160 questions may be programmed by the teacher. **£7 on cassette (d)**.

DISC DRIVES



Technomatic Disc Drives offer the best value for money. They come fitted with high quality slimline Japanese mechanisms & represent the state of art in disc drive technology. They are built to highest standards in design and production, and are all tested to their full performance capability before packaging. All drives are available with or without integral power supply. Dual Drives with PSU are supplied with generously rated integral switched mode power supplies. All 80 track TEAC drives are fitted with 40/80 Track switching at no extra charge to the user. Attractively designed steel casings are painted in hard wearing BBC matching beige paint. All drives can operate in single or double density modes. Drives are supplied complete with necessary cables, manual and formatting disc and are ready to be connected to the computer.

Single Drives

100K 40T SS TEAC **£100(a)**; TEC with psu **£135(a)**
200K 80T SS 40/80T TEAC **£155(a)**; TEC with psu **£165(a)**
400K 80T DS 40/80T TEAC **£185(a)**; Mitsubishi with psu **£195(a)**
3" 100K HITACHI Drive **£115(a)**

Dual Drives

2 x 100K 40T SS with psu: TEAC **£300(a)** TEC without psu **£225(a)**
2 x 200K 80T SS with psu 40/80T TEAC **£375(a)** TEC without psu **£275(a)**
2 x 400K 80T DS with psu 40/80T TEAC **£400(a)** Mitsubishi without psu **£325(a)**
2 x 400K 80T DS with psu Mitsubishi **£400(a)**.

Our 40/80 Track Switching Module will take care of your frustration of not being able to read or write 40 Track software on 80 Track drives. No additional cables or accessories needed. Full fitting instructions supplied. All for only **£30 (c)**.

The FLOPPICLENE disc head cleaning kit is the ideal way to ensure the optimum performance of your drives. The use of disposable cleaning discs eliminate the risk of recontamination and abrasion of the sensitive disc heads and ensure continuously reliable data capture and transmission. Floppiclene with 20 disposable cleaning discs. **£14.50 (b)**

OFFER

SCOTCH 3M DISCS

OFFER

This month we are offering these high performance discs at a bumper bargain price — not to be repeated again. The current offer will be valid for orders received until 15th October only. These discs are manufactured with advanced manufacturing techniques that have enabled 3M to set the industry standard. Their quality is such that their error free performance is guaranteed for life.

Discs in pack of 10 (c): 40T SSDD **£12.50(c)**; 40T DSDD **£17(c)**; 80T SSDD **£21(c)**; 80T DSDD **£22(c)**

DISC ACCESSORIES

Single Disc Cable **£6 (d)** Dual Disc Cable **£8.50 (d)**
10 Disc Library Case **£1.90 (d)** 30 Disc Case **£8.00 (c)**
Lockable Storage Boxes: 30/40 Discs **£14 (c)** 70/80 Discs **£18 (c)**

KENDA DMFS

This is an alternative to the Acorn DFS with several significant advantages. *Single/Double Density *Up to 379 Files per disc. *No user ram required i.e. PAGE = &EOO *CP/M compatible file structure *Can read DFS files *Can read most Acorn and other protected software. Simple plug-in installation — comes complete with utilities disc and manual.....**£120 (c)**

MODEMS

We stock a modem for every requirement, whether it is for the business, or private user, whether you require access to a public database or a mainframe, whether for local or international use. We also carry suitable software — see our section on ROMS.

TORCH UNICOMM

See our section on Torch for further details.

ACORN PRESTEL

The dedicated Prestel adaptor complete with integral, BT approved, auto-dial modem and software in ROM **£99(a)**.

BUZZ BOX

A full spec, BT approved, pocket size, direct connect modem with both originate & answer modes, full & half duplex, allowing access to many databases, bulletin-boards as well as intercomputer communications. It conforms to CCITT V21 300/300 Baud standard. Battery/mains powered. **£65(c)** BBC Lead **£3.50** External PSU **£8**.

WS2000

A world standard direct connect modem switchable between 75,300/300,600,1200/75,75/1200 baud, awaiting BT approval. It is compatible with Bell 103/113/108, 202 and CCITT V21 & 23 standards and allows you to communicate with virtually any computer system in the world. This is one of the new generation modems, that will probably cover any communications standards you would ever need. This is the modem that will cover Prestel, Micronet, Telecom Gold, Distel, Microweb, One-to-One, Bulletin Boards both in the UK and abroad, etc. etc. as well as user-to-user communication. It also has a rather useful facility of 'Reverse-Prestel' mode i.e. 75/1200 so that you can communicate with other users who only have a standard 1200/75 type modem. What possibly gives this modem its biggest advantage is its option of computer controlled switching between all modes of operation. In addition, separate auto-answer and auto-dial cards are available, giving this modem possibly the greatest potential of all. Mains powered. **£129(c)**. Please phone/write for details of optional extras.



TELEMOD-2

A BT approved modem complying with CCITT V23 1200/75 Duplex & 1200/1200 Half-Duplex standard, that allows communication with Viewdata services e.g. Prestel, Micronet etc., as well as using 1200 Baud for communicating with other computer users. Mains powered. **TELEMOD 2 £65(b)** BBC Lead **£3.50**

ACORN IEEE INTERFACE

This interface enables a BBC computer to control any scientific and technical equipment that conforms to the IEEE488 standard, at a lower price than other systems, but without sacrificing any aspect of the standard. The interface can link up to 14 separate IEEE compatible devices. Typical applications are in experimental work in academic and industrial laboratories, with the advantage of speed, accuracy and repeatability. The interface is mains powered and comes with cables, IEEEFS ROM, and user guide. **£282(a)**

ACORN TELETEXT INTERFACE

This interface enables a BBC Computer to receive and store teletext information transmitted by both BBC and ITV. In addition it allows the downloading of transmitted software. The unit comes with a ROM and user guide. **£195(b)**

TECHNOMATIC

All prices exclude VAT

EPROMER II

Our current version of the highly popular Eprom programmer is now being enhanced to provide more and better facilities for easy programming by the user. The software will maintain its superiority over all currently available similar programmers. The range of eproms handled has been widened to include the eproms with lower programming voltage and eproms which can be programmed using the fast algorithm. Control of all operations has been moved to the keyboard. The screen display has been improved to give more information. The screen editing facilities have also been modified to simplify the data entry.

Preliminary Information

- * The new Eprom Programmer will now program 2516, 2532, 2564, 2716, 2732, 2764, 27128 and 27256 + 5v eproms, and all but the 27256 in a single pass.
- * The programmer will be supplied with integral power supply, and interfaces with the BBC via the 1MHz bus. It is fully buffered and complies with Acorn protocols. There is no power drain from the computer.
- * No knobs or switches to fiddle with — total control from the keyboard.
- * Fully software driven with easy to understand instructions displayed on the screen.
- * Eprom type selectable from the keyboard.
- * Selectable programming voltage 25/21/12.5V.
- * Defaults to normal programming with high speed algorithmic programming selectable, for a device with suitable capability.
- * Continuous screen display of eprom type, option and address range selected.
- * Full screen editor with HEX or ASCII input. Constant display of logical eprom address.
- * Can read, blank check, program and verify at any address/addresses on the eprom.
- * Full Tape/Disc filing facility.
- * Several basic programs can be entered on a single eprom and called up with individual name.

ATPL SIDEWISE ROM EXPANSION BOARD

This is a well constructed expansion board that does not require soldering in its installation. It will give you an additional twelve sockets, with a 16K battery-backed RAM option. All the busses are fully buffered. **£39(d)**.

EPROMS 8K 2764-25 £6.50(d); 16K 27128-30 £21.00(d).
RAM 8K standard power 6264-15 £35; 8K low power 6264LP-15 £41.00.

SMARTMOUTH

The Original 'Infinite Speech' Synthesiser — Still the Best!
A ready-built totally self-contained speech synthesiser unit, attractively packaged with built in speaker, Aux. output socket etc. Optimum sound quality is achieved due to a tailored frequency response audio stage. It allows the creation of any English word with both ease and simplicity, while, at the same time, being very economical in memory usage. You can easily add speech to most existing programs. Due to its remarkable infinite vocabulary, its uses spread throughout the whole spectrum of computer applications — these include educational, industrial, scientific, recreational etc. — simply plugs into the User Port. No ROMs are needed. Smartmouth is supplied with demo and development programs on cassette and full instructions. **£37(c)**.

UV ERASERS

UVIT with built-in timer and safety switch **£59(b)**.

'TIME-WARP' REAL-TIME CLOCK CALENDER

A low-cost compact unit that opens up the total range of Real-Time applications, and adds a new dimension to the personal computer. Though built to exacting professional standards, it is at a price previously unattainable, and brings it within reach of all BBC Computer owners. With its full integral battery backup, possibilities include an Electronic Diary, continuous display of 'on-screen' time and date information, automatic document dating, precise timing and control in scientific applications, recreational use in games etc. — its uses are endless and are simply limited by ones imagination. Simply plugs into the User Port — no ROMs needed. Extensive applications software supplied on cassette (easily transferred to disc) and full instruction manual. Please phone for details. **£29(c)**.



TERMI
as a du
at which
with 40/8
of incom
PRESTEL

COMM
program
features
received
Allows f
sent to a
£59(d).

COMM
use yet
mode an
copied i
of proto
using XI
based e
within t
features
retrievin

GER

The D
MANAC
Date
your sy
The sys
applica
referen
unlimit
records
search
any on-
Differen
Please

Using
busine
efficien
records
is mac
paperw
speedy
can be
linking
Invoici
produc
custom
and ge
orders
mainte
accoun
supplie
Control
and is
valuati
status
All nar
produc
mailsh
indust
gumm

01-208 1177

Please add carriage: (a) £8; (b) £2.50; (c) £1.50; (d) £1.

COMMUNICATION ROMS

TERMI This is a semi intelligent terminal emulator allowing the BBC to act as a dumb terminal, slave BBC graphics terminal, or VT52 terminal. The rates at which data is sent or received is easily set up with rates of up to 4800 Baud with 40/80 col. selectable. Allows files to be transmitted from disc, or a copy of incoming data to be sent to a file or to a printer. (Termi is not suitable for PRESTEL). £28(d).

COMMUNICATOR This is a full 80 col VT100 terminal emulation program on 16K eprom. It is a more advance program than TERMI and features easy to follow screen menus. The rate at which data is sent or received is easily set up with rates up to 19200 Baud with 80 column text. Allows files to be transmitted from disc, or a copy of incoming data to be sent to a file or to a printer. (Communicator is not suitable for PRESTEL). £59(d).

COMMSTAR This intelligent communication facility is extremely easy to use yet very versatile. It features a terminal mode, a full VT100 emulation mode and a special PRESTEL mode. In Terminal mode, all input may be copied into a buffer in memory over which full control is provided. Controls of protocols is very simple and any type of file (not just ASCII) may be sent using XModem protocols. The Emulation mode may be used using a disc based emulation file to emulate virtually any terminal type including VT100, within the capabilities of the BBC. In PRESTEL mode all normal Prestel features are available, including downloading of software, saving and retrieving of pages etc. etc. £29(d)

GEMINI DATAGEM

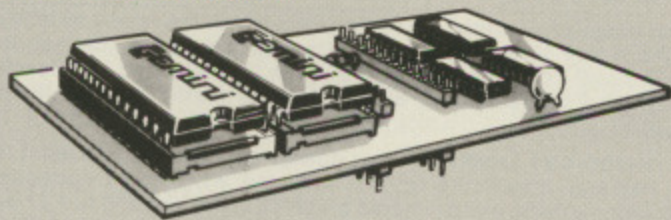

The Definitive Random Access, 24K ROM Based DATABASE MANAGEMENT SYSTEM.

Datagem is the first truly flexible database for the BBC Micro that can make your system really useful and efficient, saving you money in the long run. The system includes a carrier board containing two Eproms, demonstration applications disc in both 40/80T, professional documentation with quick reference card, and 'Trans' utility program. Features include: *almost unlimited file size (max 10MByte) *supports up to 4 drives *Max of 5000 records per file *max 6K record size *max of 62 fields *9 level hierarchical search system with facilities to store results of searches. Searches can be any one of the following: Search, Include, Exclude, Combine, Common or Difference *user defined variables *generates form letters from records. Please ask for leaflet. £112(c).

ACORNSOFT/MIRLE Business software

Using this well designed, cost effective business system, the small businessman is able to reduce repetitive tasks significantly, and increase efficiency at the same time. Instead of making individual entries in stock records, VAT records, purchase records, sales records, and so on, the entry is made just once. As well as taking care of the production of all the paperwork, the system also allows for instant access to information and speedy analysis of recorded data. The beauty of the system is that packages can be purchased and used individually with the option of, possibly later, linking them with the other packages.

Invoicing: Stores details such as names & addresses of customers, products, VAT numbers, etc. **Order Processing:** You can confirm your customers orders, check on their requirements, prepare despatch notes, and get speedy order analysis of single orders, selected orders, or all the orders stored on the data disc. **Accounts Receivable:** Provides accurate maintenance of customer accounts, and instant access to customer account status. **Accounts Payable:** Provides accurate maintenance of supplier accounts, and instant access to supplier account status. **Stock Control:** allows you to keep an eye on product records, record stock receipts and issues, report on restocking requirements and to analyse stock for valuation and physical reconciliation as well as instant access to stock status and automatic analysis of stock by quantity and value. **Purchasing:** All names and addresses of suppliers can be retrieved instantly for the production and printing of orders. **Mailing System:** When sending a mailshot, you can specify criteria such as size of company, location, type of industry, value of business etc. Will print names and addresses on either gummed labels or printed paper. £22(d).

BBC FIRMWARE

VIEW Word Processor Rom on special offer at £48(c).

This is the new version V2.1. Advantages include being able to print straight from memory, as well as editing in any mode. Complete with comprehensive manuals to Acorns usual high standard.

WORDWISE One of the most popular word processors for general use £34(d). Wordwise SpellCheck Disc — A must for any serious word processor user. Normal price £16.50(d). If bought with Wordwise: No p&p and only £14.

ULTRACALC From BBC Publications: The only spreadsheet ROM for the BBC that offers features found in the most sophisticated spreadsheet programs, like the handling of labels as well as numbers as values, and allowing a search by a meaningful name instead of just a number etc. Efficient memory usage allows large spread sheets to be constructed. Facilities and commands include, variable width column, Sum, Replicate, Insert, Delete, & most mathematical functions. It helps to create and manipulate pricelists, balance sheets, payroll, c/flow forecasts, order entry, small databases, scientific calculations. £69(c).

BCPL A full implementation of the BCPL compiler language from Acornsoft. It consists of the BCPL language ROM and a disc containing the BCPL Compiler, a Screen Editor, a 6502 Assembler, other utilities and program development aids, and some examples of BCPL code. A comprehensive 450 page user guide is included. It can be used to develop games programs and commercial packages, to develop system software, to write control systems, and to produce programs which otherwise would need to be written in assembler. £86(b).

BCPL CALCULATIONS PACKAGE: supplied on disc, it supports floating point, fixed point and fast integer calculations. It includes the BCPL calculation files, example files and a comprehensive user guide. £17.30(b).

UTILITY ROMS

DISC DOCTOR This general purpose ROM adds 20 commands to the DFS system. It includes a formatter, sector editor, tape-disc & disc-tape routines, a powerful disassembler, commands for listing function key definitions for editing etc. This ROM will obviate the need to go for non standard DFS systems (with their inherent disadvantages) as it overcomes many of the Acorn DFS's shortcomings. £28(d).

GREMLIN Contains a full machine code monitor including features such as a disassembler, memory move and search routines. Also feature a full expression evaluator and an assembler. Can single step through ROM & RAM as well as any sideways ROM. Works in any mode with full status display. Up to 8 breakpoints can be used and it has a special mode for debugging graphic programs. £28(d).

EXMON This extended machine code editor provides 35 new commands. Features include machine code relocater, single stepping, memory search and full assembler & disassembler. £20(d).

TOOLKIT This ROM adds 27 new commands to the BBC BASIC. These include a full screen editor, merge, relocating data in memory, program compactor, listing of variables and memory search. £23(d).

CARETAKER This adds 17 new commands to the BASIC which include: renumber, squash, exchange insert, single key entry of BASIC keywords etc. £28(d).

GRAPHICS ROM This ROM includes over 28 new graphics related commands which can be used in BASIC programs. Features include: sprites, LOGO Turtle graphics, fill routines, shading, large characters, rotation, scaling and 3D plotting all using '*' commands. £28(d).

PRINTMASTER This ROM features the most versatile screen dump for EPSON MX/RX/FX80 and Kaga 810 printers. It supports three types of dumps. The first allows any graphics on the screen to be dumped. Colours appear as shades of grey. Any part of the screen can be printed at any position on the paper in any one of four orientations. The screen dump may be magnified by any factor x2, x3, x4 etc. A special feature allows true MODE 7 screen dumps with TELETEXT text & graphics. The second dump allows any text to be dumped whilst the third dump will print the contents of a file on disc whilst the computer is doing other things. This is not all. All printer functions can be called up using the *command. *DEFINE allows the user to define his own characters and store them. *GPRINT allows printing of enlarged text in any position, orientation, size & shade. *WINDOW allows windows to be defined in any size and position on the screen. In short this one ROM does it all. £28(d).

SOFTWARE

TURTLE GRAPHICS

Ideal as an introductory package for teaching geometry, mathematics and graphics at an elementary level. **£17.30 on disk.**

MICROTEXT

This authoring system was developed by the National Physical Laboratories. It is a programming system designed to simplify the production of a wide range of man-computer dialogues. Using Microtext's simple commands, the user can draw up any number of "frames", each containing text and/or graphics. A series of frames build up into a complete module. Each program can consist of more than one module. Using Microtext, an expert in any field can construct their own complete courses of computer-based instructional material. Applications include interviewing systems, teaching packages, training courses and interactive demonstrations and simulations. Available on Cassette and Disc. **£52(a) Disc; £43(c) Cassette.**

S-PASCAL

Contains a subset of Pascal — one of the most popular programming languages available today. The package contains the S-Pascal compiler on disc, several example programs and a comprehensive user guide. **£17.30(d)**

ACORN LISP

Lisp provides more flexibility in data and control structures than traditional languages. Is easy to learn, and is widely used for writing substantial and sophisticated programs, with practical applications. **£17.30(d) Disc; £14.35(d) Cassette.**

ACORN FORTH

Forth is a compiled language, so programs run very fast (typically five times faster than Basic). **£17.30(d) Disc; £14.35(d) Cassette**

DESIGN

Design is a screen processor which allows information to be displayed in a format suitable for demonstrations, slide projections, handouts or presentations. **£16.50(d) Disc; £8.50(d) Cassette.**

SUPERPLOT

Superplot is ideal for anyone interested in screen representations of mathematical functions. **£16.50(d) Disc; £8.50(d) Cassette.**

SPELLCHECK

The spelling checker available for both Wordwise and View. **£16.50(d) Disc; £8.50(d) Cassette each.**

MASTERFILE

A general purpose data base that is extremely useful, allowing vast amounts of information to be stored. The disc version allows up to 17 fields per record, and the only limitation as to the number of records, is the capacity of the disc. Typically, using 5 fields, about 2000 records may be stored on a 100K disc. **£16.50(d) Disc.**

PAINTBOX

A joystick drawing program for the BBC. You can use it to doodle or to design sophisticated full colour pictures. **£8.50(d) Cassette.**

VU-Type This is a powerful and versatile typing tutor developed and published in association with Pitmans. It is designed to enable you to acquire or enhance typing and keyboard skills. **£12(d).**

Record Keeper A personalised program for storing and retrieving data for a variety of purposes. Report facility lets you choose how to generate the layout of your data and display and print it. The program also contains alternative versions for transfer to disc. **£16.50(d).**

BOOKS

(No VAT p&p £1.50 per book)

Let your BBC Teach U To Program.....	£3.50	DIY Robotics & Sensors.....	£6.95
100 Programs for the BBC.....	£6.95	Disc Book.....	£3.50
30 Hour Basic.....	£6.95	Disc Systems.....	£6.95
35 Educational Progs.....	£6.95	Discovering BBC M/Code.....	£6.95
6502 Applications.....	£10.95	Essential Maths BBC/Electron.....	£5.95
6502 Assembly Lang Programming.....	£13.95	Forth.....	£7.50
6502 M/Code for Beginners.....	£5.95	Friendly Computer Book.....	£6.95
6522 VIA Book.....	£4.50	Graphics on the BBC Micro.....	£6.95
6809 Assembly Lang Programming.....	£13.95	Graphs & Charts.....	£7.50
Advanced Graphics with BBC.....	£9.95	Interfacing the 6502.....	£10.95
Advanced M/C for the BBC.....	£7.95	Intro BBC Micro.....	£5.95
Advanced Prog Tech for BBC.....	£8.95	LISP.....	£7.50
Advanced 6502.....	£11.75	Making Music on the BBC Computer.....	£5.95
Advanced User Guide.....	£12.50	Micro BBC Basic Sound Graphics.....	£7.95
Assembly Lang Prog on the BBC.....	£8.95	MOS Memory Data Book.....	£3.95
Assembly Lang for the BBC.....	£8.95	Prog the BBC Micro.....	£6.95
Assembly Lang Prog for Electron.....	£26.00	Programming the 6502.....	£10.95
Assembly Lang Programming Birnbaum.....	£8.95	Programming the 6809.....	£11.95
Basic Prog on the BBC Cryer.....	£5.95	Programming the 8086/8088.....	£11.75
Basic Rom User Guide.....	£7.95	Programming the BBC.....	£6.95
Basic II Rom User Guide.....	£4.00	Programming the Z80.....	£13.45
BBC Basic.....	£5.95	Start Prog with Electron.....	£5.00
BBC Basic for Beginners.....	£6.95	Step by Step Prog Book 2.....	£5.95
BBC Micro for Beginners.....	£6.95	Structured Programming.....	£6.50
BBC Micro Disk Companion.....	£7.95	The Electron Book.....	£5.00
BBC Micro Expert Guide.....	£6.95	TORCH Z80 Disc Pack User Guide.....	£10.00
BBC Micro Graphics & Sound.....	£7.95	TTL Data Book Vol-1.....	£9.00
BBC Micro in Education.....	£6.50	TTL Data Book Vol-2.....	£8.20
BBC Micro Revealed.....	£3.50	BBC User Guide.....	£15.00
BCPL User Manual.....	£15.00	Using BBC Basic.....	£10.00
Beyond Basic.....	£7.25	Using Floppy Disks.....	£6.95
Creating Adventure Progs.....	£6.95	Using the 6502 Assembly Lang.....	£14.50
Creative Graphics.....	£7.50	Z80 Applications Book.....	£13.45

EDUCATIONAL PROGRAMMES

A selected range of cassette based software for all the family to enjoy and at the same time arouse curiosity and create an interest in computers. Apart from providing hours of fun they will also help teach the young ones fundamentals of English and Maths without them realising it.

Mr T's Alphabet Games Watch how quickly the children learn to identify, name & match the letters and also write them correctly. Amusing sound effects and animated graphics make learning fun. **£7(d).**

Number Gulper A gripping fast moving game that helps develop arithmetic skills. 19 levels of skill to cater for all ability levels. Even parents might find upper levels embarrassing. **£7(d).**

Words Words Words A stimulating game to help young children with reading & spelling. Pictures are shown on the screen and the child has to type in the name of the object shown. If correct, the object takes its place in a scene. When all objects have been correctly identified the scene comes to life. **£7(d).**

Tree of Knowledge A interactive program that teaches categorisation. The computer is first educated about a group of objects — e.g. plants or birds. The database, or tree created in this way is then used in playing a guessing game. Two sample databases are supplied on the program. New databases are saved and loaded from within the programs. **£7(d).**

Royal Quiz Pit your knowledge of Royalty against Anthony Holden, the Royal Biographer. Do you know who told the queen that she didn't recognise her "without her crown on"? The quiz will tease, teach and entertain. **£7(d).**

Science Fiction Quiz A SF quiz in the widest sense, especially adapted from the Weidenfeld Quiz book that will provide hours of edification and amusement. **£7(d).**

TECHNOMATIC SERVICE

Our in depth stocks allow us to offer immediate deliveries on most items and our aim is to provide the best available products at competitive prices. In addition to the items listed above we carry extensive stocks of: connectors, connector assemblies, components including TTLs, CMOS, RAMS, EPROMs and CPUs. Spares for the BBC computers are normally available from stock. Orders from government departments, public bodies, hospitals, schools, colleges, universities and recognised PLCs welcome. We specialise in world wide exports. No VAT on exports. Our specially negotiated freight charges to many countries ensure the customer considerable savings on charges.

TECHNOMATIC LTD

MAIL ORDERS TO: 17 Burnley Road, London NW10 4ED
(Tel: 01-208 1177 Telex 922800)

SHOPS AT: NW London: 15 Burnley Road, London NW10 4ED

⊕ (Dollis Hill 2 mins walk, ample car parking space)

West London: 305 Edgware Road, London W2. Tel: 01-723 0233

(Near Edgware Road) ⊕

01-208 1177

All prices exclude VAT. Please add 50p carriage unless indicated as follows:

(a) £8: (b) £2.50: (c) £1.50: (d) £1.00.

add 15% VAT to the total order value. For fast delivery telephone your order quoting VISA or Access card or official order number.

(Minimum telephone order £5).

THE BEEB BODY BUILDING COURSE

Part 19

At last...the Beeb blows its own trumpet!

MY wife appeared at the door to the computer room holding a glass of fizzing effervescent salts. "I could hear your stomach rumbling from downstairs", she said, proffering the liquid.

How could I tell her there was nothing wrong and the sounds were emanating from my latest hardware project? So I dutifully drank the liquid fizz and thanked her, and consequently spent longer than usual contemplating what I should write this month.

The topic I am exploring this month is the synthesis of audio waveforms. This enables the computer to sound like anything you care to mention. To accomplish this trick we need a little hardware and a lot of software.

While the BBC Micro has more types of interfaces than most computers, one it lacks is a D/A (digital to analogue) converter.

The analogue input socket (joystick socket) will feed into the computer a digital representation of any voltage applied to it. As the voltage can be a continuously varying (analogue) quantity, the converter must change it into a number of fixed precision.

We say that the voltage has been "quantised" or split into discrete steps or quanta. This type of circuit is known as an A/D (analogue to digital) converter.

With a D/A converter a number is converted into a voltage which varies in steps. If each step is very small then the output voltage appears to be continuously variable. In this way the computer can generate a signal which can be used to control or, as we shall see later, generate a musical tone.

At this point I would like to say goodbye to all those readers who go and look at the games when they hit the first hard paragraph. It's been nice meeting you again and I'll see you next month.

Now, for the rest of the foolhardy, let's look at how we can spirit an analogue voltage from a digital signal.

Remember that a number is represented inside a computer as a series of binary bits - that is, each bit can be on or off. In addition, when we interpret the

By MIKE COOK

number we give a weighting to each bit so that each successive bit has double the significance of the previous bit.

You can think of a bit as a switch being on or off. We can arrange these switches to feed current into a summing junction. If the amount of current each bit controls is proportional to its binary weighting then the current flowing into the junction will be proportional to the number producing it.

Phew! It's really much simpler than it sounds - have a look at Figure I.

Here there are three switches which

can connect each resistor to a positive voltage or to earth. When a resistor is connected to the positive voltage current can flow into the junction. We say it is "sourcing current".

When it is switched to earth, current can flow out of the junction and it is said to be "sinking current". The amount of current each switch sources or sinks is controlled by the value of the series resistor.

The absolute value of each resistor does not matter - only its relative value. That is why they are labelled R, 2R, 4R. They could be 3k, 6k, 12k or any other values in the correct ratio.

Consider what happens when all the switches are connected to the reference voltage. Each will be sourcing current and the maximum amount of current will flow in the load resistor.

If you swap over S1, that amount of current is no longer being added to the junction but is being taken away from it.

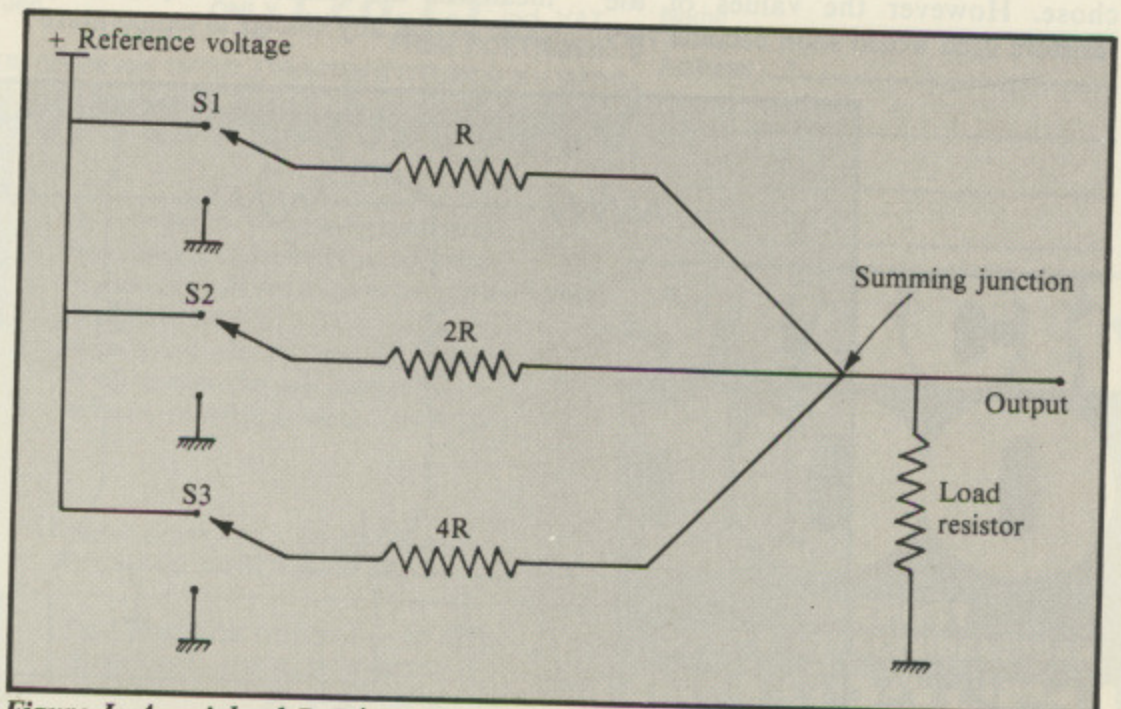

Figure I: A weighted R D/A converter

THE BEEB BODY BUILDING COURSE

From Page 149

Therefore the total current in the junction is halved.

However if instead of switching over S1 you switched S2, one quarter of the maximum current would be diverted and so the current would drop to three quarters. The final switch S3 makes an eighth contribution.

Now all we need to do is to make each switch be controlled by a single binary bit of the number we wish to convert and we have our D/A converter.

Normally we want to have a voltage output rather than a current output. This is easily achieved as the current flowing through the load resistor generates a voltage across it. This voltage therefore is proportional to our digital number.

This type of converter is known as a weighted resistor converter as each resistor has a value proportional to the binary weighting. If you like you can verify that this converter works by mathematically calculating the current flow for every combination of switch.

All you need to know is Ohm's law and how to calculate the value of parallel resistors – but I will leave this as an exercise for you. (*Translator's note – This phrase really reads: I am too lazy to do this and most of you will probably find it boring anyway.*)

In the above example we only had three switches (bits) and so the voltage we could produce could only be varied in eight separate steps (two to the power three).

There is nothing to stop us adding extra switches and doubling the series resistor for each. In this way we could construct an analogue to digital converter of whatever precision we chose. However the values of the resistors used would soon become very

difficult to fabricate.

There is an alternative way of generating a D/A converter which only uses two values of resistor and is known as the R-2R resistor ladder. It is shown in Figure II.

It consists of a series of summing junctions called nodes. At each node the current is split in half so that the contribution of current from any one switch depends on how many nodes it has passed through to reach the output.

In this way as many switches as required can simply be tagged on to the end. When the circuit is drawn it looks like a ladder – hence its name.

The number of extra switches is limitless if all the resistors are of exactly the same value. However in practice a resistor can only be manufactured to a certain tolerance and it is this which actually limits the number of switches that can be added.

This is usually quoted as the linearity error of a D/A converter and is normally plus or minus half the least significant bit. This ensures that if the number increases by its smallest increment the analogue output will rise.

If this were not the case the linearity error would be greater than the least significant bit and monotonicity would be lost.

Monotonicity, by the way, is just a jargon word meaning that as you increase the number going in you increase – or keep the same – the voltage going out.

While we could construct a D/A converter from precision resistors and electronic switches there is little point as D/A converters are readily available at a reasonable price.

They come in a single package, which means all the resistors are physically close so that any change in temperature

affects all of them equally. This is known as thermal tracking.

Obviously the more precise a D/A converter is, the more expensive it is. The one I have chosen to use with our project this month is an 8-bit converter made by Ferranti – the ZN428E-8. Figure III shows the internal configuration.

As it is 8 bits we will then have 256 separate steps in our output voltage – the same as specified by a single byte. It contains a latch to hold the digital input, but in our application this will not be needed as we are connecting it directly to the user port.

You will see that it also contains an internal reference voltage generator which is the maximum produced by the converter and can be fed from an external source if required.

The output of the D/A converter is zero volts to the reference voltage at an impedance of 4k. This needs to be fed into an amplifier to make it a little more robust.

As there are four amplifiers in the LM324 package it seems a waste to throw them away so I have configured them as a low pass filter. The whole

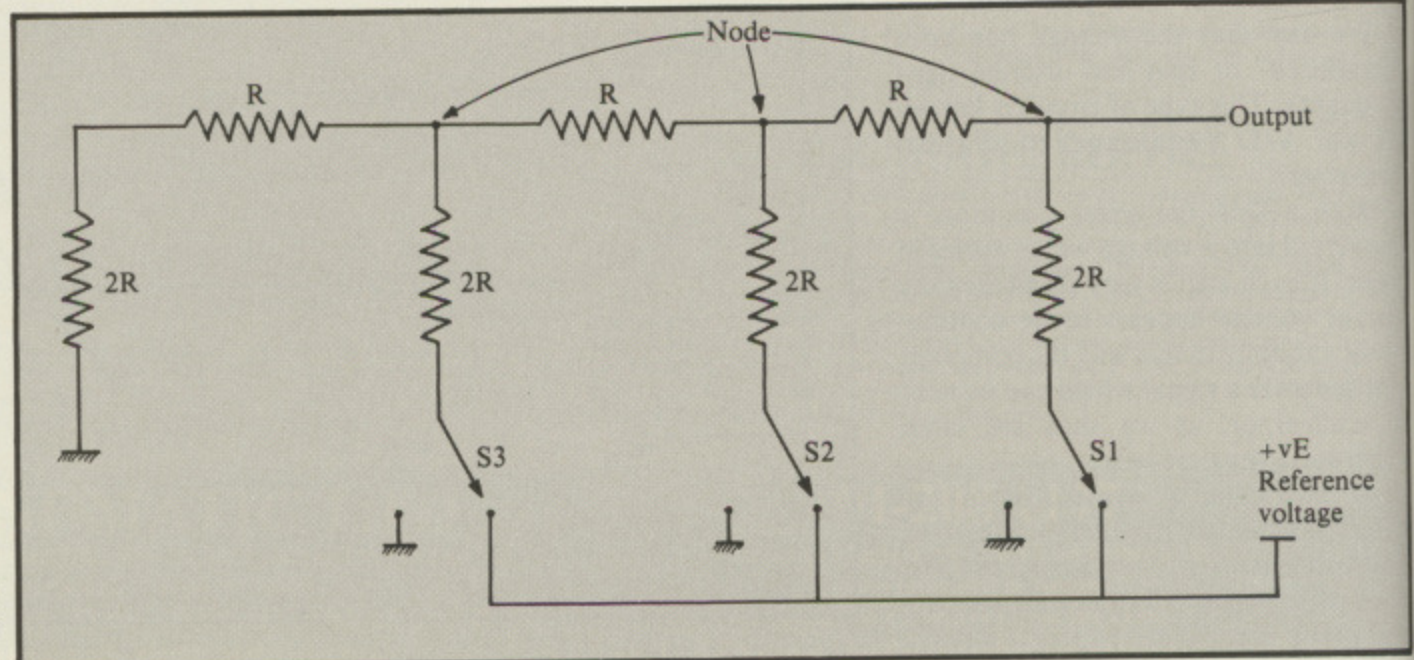

Figure II:
A R-2R ladder
D/A converter

NEVE

Special
cassette
games
BBC 'B'
Electro

Cun
CSX10
CSX20
CSX40
+ man

Sidew
2764's
27128
8271's

Add



OFFICE
36 Der
Hinckle
Leics.



GR

An e
prog
use,
inter
beco

● use
● choo

BB

NEVER KNOWINGLY UNDERSOLD — PRICE FOR PRICE, SERVICE FOR SERVICE

Computers

Special Offer — BBC 'B' + cassette recorder + 5 Acornsoft games £346.90
 BBC 'B' + D/I £408.00
 Electron (ex stock) £173.00

Cumana Disc Drives

CSX100 £120.86
 CSX200 £163.00
 CSX400 £175.00

+ many more.

Eproms

Sideways ROM Board £36.00
 2764's P.O.A.
 27128's P.O.A.
 8271's P.O.A.

Printers

Epson RX80 £188.95
 Epson RX80 F/T £213.00
 Epson FX80 £316.00
 Epson MX100 £366.00
 Epson FX100 £424.00
 Daisywheels from £250.00
 Printer leads £8.50
 Paper (2,000 sheets) £11.00

Monitors

Microvitec 14" £170.00
 Sanyo's from £199.00
 Saba TV/monitor £200.00

Accessories

Disc Interface £85.00
 Wordwise £32.00
 Quickshot Joysticks from £5.95

SAE for lists — state machine.

Add 80p carriage - small items. £7.00 carriage - large items.
 Add 15% VAT to total

Access and Barclaycard telephone orders to JANE on 0455 612139

Leigh Computer Systems

OFFICE	SHOP	OPENING SOON:
36 Derby Road, Hinckley, Leics. LE10 1QF	7 Coventry Road, Hinckley, Leics. Tel: 0455 612139	75 Cross Street, Sale, Manchester Tel: 061-905 2144

TWO WAYS TO ENSURE YOU GET

THE MICRO USER

EVERY MONTH

1. Complete and mail subscription form on Page 217
2. Hand this form to your newsagent.

Please reserve me a copy of The Micro User magazine every month until further notice.

- I will collect
 I would like it delivered to my home.

Name _____

Address _____

Note to newsagent: The Micro User should be obtainable from your local wholesaler, or contact Steve Fletcher, Circulation Manager on 061-480 4153.

STACK LIGHTPEN 100

ATARI...VIC-20...CBM 64
 A beautifully styled, high quality colour light pen for the BBC, with touch controls.

NEW RELEASE
BBC

Easy to use...simply hold the LIGHT PEN against the T.V. screen, place a finger on the 'Touch Contact' and the pen is working. You can produce programs in which the LIGHT PEN places data (alphanumeric or graphical) onto the screen, removes data from the screen

or triggers off a series of events or instructions. Complete with user manual and a free game on cassette (worth £5.75) to get your software library started.

ONLY **£28.75** incl. VAT
FREE POSTAGE!!

Stack Products are available from selected branches of: GREENS DEBENHAMS, DIXONS, JOHN MENZIES, SPECTRUM, W.H. SMITHS

GRAPHIX-ED

An excellent colour graphics program for your BBC. Easy to use, but be warned, any slight interest in graphics can quickly become an addiction!

- use normal, medium or hi-res graphics
- choose 1, 4 or 16 colours

- controlled by single letter commands
- optional grid display to aid accuracy
- duplicate pictures on other parts of the screen
- picture buffer
- save and recall pictures from cassette
- comprehensive user manual
- quick reference guide to commands

THE COMPLETE PACKAGE COSTS **£9.00** incl. VAT

Full joystick control — in any direction — and it fires too!!

ONLY **£13.80** incl. VAT

BBC JOYSTICK

HOW TO ORDER

Most computer dealers either stock or can obtain **STACK 100** products for you, or you may order direct from us. Packaging and postage is FREE within the U.K., overseas customers please add airmail postage.

Payment may be made by sending a cheque, postal order or by credit card, 24hr answerphone service.

Please send me full details of your BBC products.

Name _____

Address _____

STACK 100

FREEPOST
 BOOTLE, MERSEYSIDE L20 0AB

0519335511

24hr answerphone

From Page 150

circuit diagram of this month's project is shown in Figure IV.

As you can see the lowpass filter makes up about half the complexity. The outputs from the user port are taken into the converter and the voltage emerges on pin 5.

This is then amplified so it is the maximum that can be supplied by this amplifier on a single 5 volt rail and then sent to a voltage follower buffer amplifier. The output from this is available for use and is also fed via a potentiometer to a 4th order Butterworth low pass filter.

Owing to lack of space I will duck out this month on a detailed explanation of how a filter works and how to calculate the component values. Suffice it to say that the circuit will let through low frequencies unchanged and will attenuate high frequencies. This particular design starts attenuating signals at 3KHz.

See the panel on Page 154 for details on how to buy the kit. Note that, in response to many requests, you can also buy the printed circuit boards separately.

Construction is, as ever, by slotting the components in and soldering up. You will also need a ribbon cable connector such as that in Body Build Pack No. 2.

Well, having built it how do we drive it? In this case it is very simple. Just set up the user port to be all outputs by:

`?&FE62=&FF`

and then any number poked to the user port will appear as an analogue output on the board. For example:

`?&FE60=128`

will set the output at the halfway mark.

Those working with the second processor attached to the BBC Micro will have to make the appropriate OSBYTE calls to achieve this.

In many cases the voltage output will need further amplification in order to drive the device you want to control. The exact circuit of this will depend on the power requirements of the device and it is difficult to give general guidelines.

So for the rest of this month's article we will look at another application of the D/A converter - that of a programmable waveform generator.

There are many applications where it is desirable to specify an exactly controlled waveform. One of the more interesting is the synthesis of sound.

While the whole topic can (and will) take several articles just to outline we can make a substantial start here. The only hardware required is what we have already. The magic in this case lies purely in the software.

If we wish to generate a specific waveform we only need to generate a series of numbers which describe the waveform and send them out in sequence to the D/A converter.

So we can make our computer generate any sound - from trumpets and organs to whales and diesel engines. The rub is that we need a description of it in the computer.

In practice, the technique for a periodic waveform is to calculate each point on the waveform and store it in memory as a look-up table. Then we can play it by outputting successive samples to the D/A converter.

The latter task takes up all the microprocessor's time so the waveform has to be precalculated.

The program in the listing allows you

to generate any periodic audio waveform. If you connect the filtered output of the D/A converter board to an audio amplifier or the audio input pin on the 1MHz bus connector you will be able to hear the result.

The filtering is necessary because, as the waveform is made up of discrete steps, each step will generate a noise. This is known as sampling noise and is at the same frequency as the sampling rate.

As this is going to be many times higher than the fundamental frequency it can be filtered out to give a clean sound.

One of the reasons why musical instruments sound different is that they generate different types of waveform. With this program you can explore the relationship between waveform shape and sound.

It could even be developed into a fully-fledged music generation program, although this probably would require the use of several other techniques to be described in a later article.

When you run the program you will be asked how you want to specify the waveform. This can be done in two ways - by hand or mathematically.

If you choose to do it by hand you can use the cursor keys to trace one cycle of your waveform. This is handy for generating complex step sequences of any other shape you care to imagine.

If you choose the mathematical method you will be asked for an expression. This is not quite so daunting as it sounds.

All waveforms can be made up from a sum of SIN and COS waves. A pure tone can be represented by simply SIN(T) where T is the time or frequency.

If you want a quiet tone then $0.5 * \text{SIN}(T)$ will give a tone of half the size. If you want the second harmonic - pure tone of twice the frequency - then $\text{SIN}(T * 2)$ will produce it. The fun comes when you start specifying sums of different amounts or different frequencies.

If you specify non-integer values you will, in effect, produce two or more notes played simultaneously. If these are carefully chosen you can generate chords. However this tends to introduce a discontinuity at the end of the waveform that can add extra harmonics to the sound.

In this way you can mimic the harmonic mix of any instrument. In fact the stops on an organ just add a certain amount of each harmonic to the sound in exactly the same way, so any texture of sound may be built up.

You simple other shape series of function. If placed by 18 different sound the ear compo. When it will fascinate getting function. If you off the and re only 2 if you maxim Re

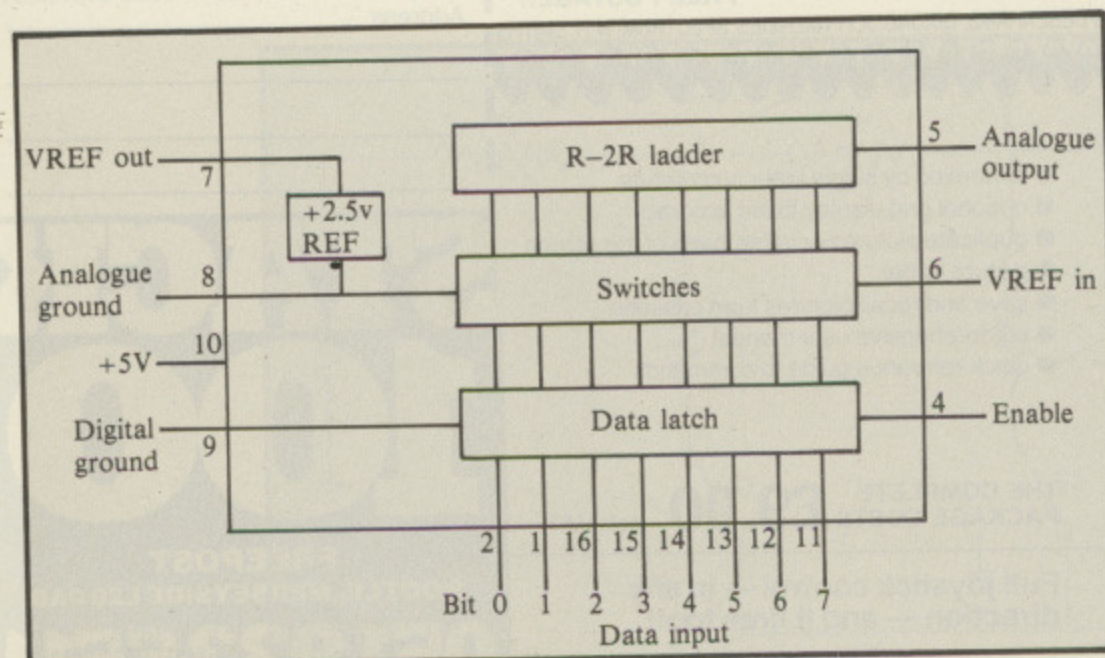

Figure III: Inside the ZN428E-8 D/A converter

THE BEEB BODY BUILDING COURSE

You don't have to be content with simple sums of harmonics. You can try other functions as well, although any shape can eventually be built from a series of sums. Table I gives some of the functions you may care to try.

If you specify a COS function in place of a SIN the wave will be shifted by 180 degrees. It will produce a different looking waveform but will sound exactly the same. This is because the ear is not sensitive to the phase component of a waveform.

When you have specified the function it will be plotted on the screen. This is fascinating in itself and is very useful for getting the feel of mathematical functions.

If your chosen wave description goes off the screen it is automatically scaled and replotted. This is because there are only 256 steps in the D/A converter and if you cover the full range you get the maximum volume.

Remember if your function contains

a syntax error the program will crash, so simply type RUN to set it off again. You can then play the waveform by pressing one of the number keys. Each key will produce a different note although not on a musical scale.

By pressing L you can alter the length of note that is produced - type in a number between 1 and 255. When you get tired of listening to the tone press D and you can define another waveform.

Let's see how the program works.

First of all the machine code that is going to produce the note is assembled. If you are working with the second processor you will have to arrange that this code is transferred and run in the I/O processor, as the appropriate OSBYTE calls to transfer the data to the D/A converter are not fast enough.

Then after the preamble you select the method of entering the waveform. If cursor keys are chosen, a procedure fills the waveform array $W(n)$ with the tracing you make. Note that in this

procedure the cursor keys are disabled from editing and enabled at the end. Therefore when you are debugging this program you will have to type in *FX4,0 to regain normal editing functions.

When the waveform reaches the end it is automatically redrawn and the next stage is entered.

If you take the mathematical approach your function will be plotted.

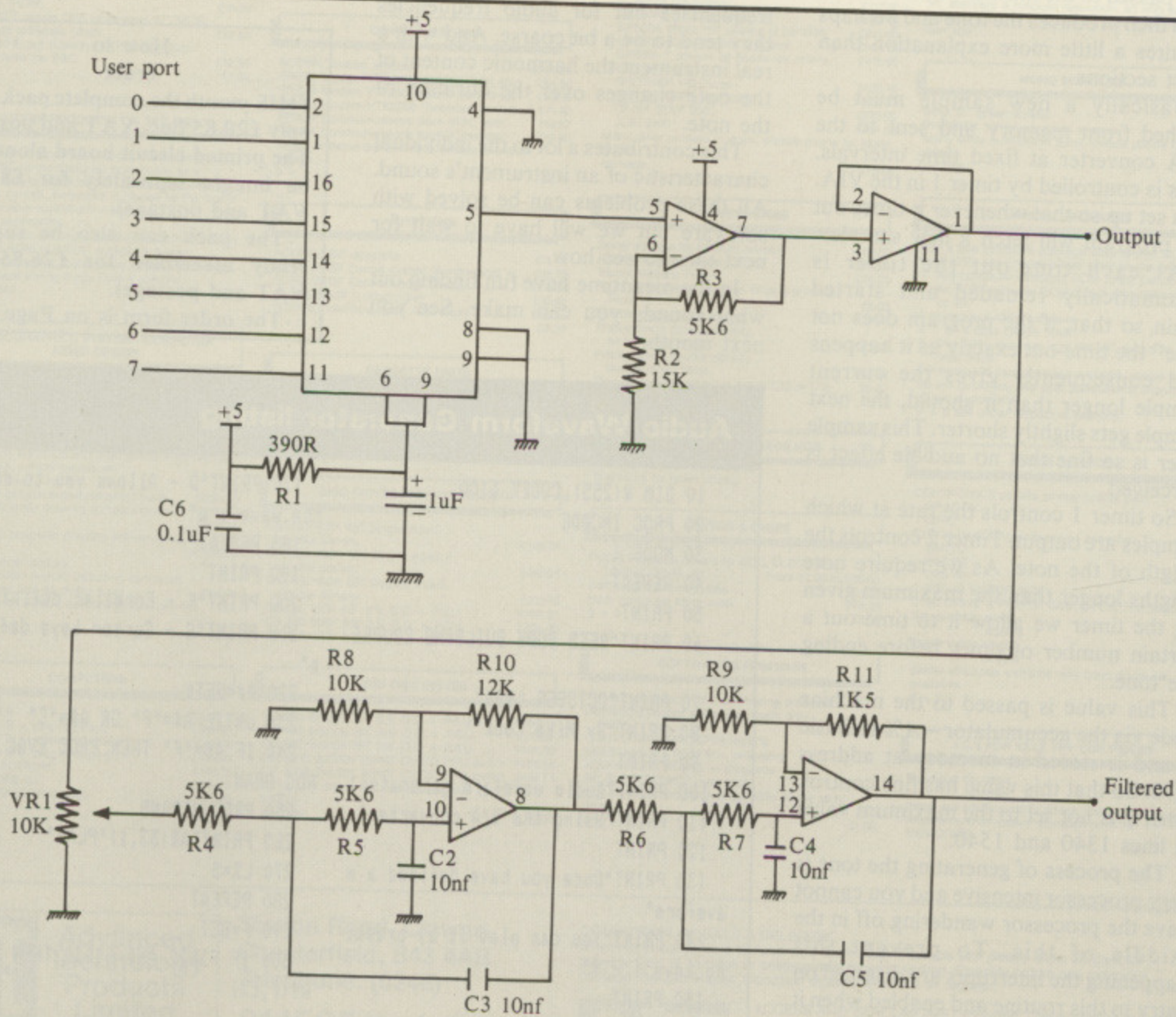

Figure IV: The D/A converter with filtered output

From Page 153

If there are a lot of terms this might take some time. And do not worry if it disappears off the top of the screen for a time – you will see the whole waveform when it is scaled.

The next step is that the array $W(n)$ containing the waveform is placed into memory starting at &A00. It makes the programming easier if the waveform table occupies a complete page of memory.

This can be changed to any page that is convenient for your set-up, but bear in mind you will have to change line 1440 to reflect the new address.

As $W(n)$ contains the value of each point on the waveform in screen coordinates it is compressed in to byte-size chunks before storing in memory.

You can then play the notes. Each key pressed is converted into a value and passed to the machine code routine. This then produces the tone and perhaps requires a little more explanation than most sections.

Basically a new sample must be fetched from memory and sent to the D/A converter at fixed time intervals. This is controlled by timer 1 in the VIA. It is set up so that whenever it times out the program will fetch a new sample.

At each time-out the timer is automatically reloaded and started again so that, if the program does not "see" the time-out exactly as it happens and consequently gives the current sample longer than it should, the next sample gets slightly shorter. This sample jitter is so fine that no audible effect is perceived.

So timer 1 controls the rate at which samples are output. Timer 2 controls the length of the note. As we require note lengths longer than the maximum given by the timer we allow it to time out a certain number of times before ending the tone.

This value is passed to the machine code via the accumulator – $A\%$ in Basic – and is stored in memory at address &70. So that this value has fine control, timer 2 is not set to the maximum value in lines 1340 and 1540.

The process of generating the tone is very processor intensive and you cannot have the processor wandering off in the middle of this. To prevent this happening the interrupts are disabled on entry to this routine and enabled when it is completed.

With this you should be able to make all sorts of sounds. However as 256

Functions to try

SIN(T)	A simple pure tone.
SIN(T) +1/3*SIN(T*3) +1/5*SIN(T*5) +1/7*SIN(T*7)	First four terms of an approximation to a square wave.
SIN(T)*SIN(T*10)	Modulation function.
T	A saw-toothed waveform.
SIN(T*T)	A rising pitch over the duration of the waveform.
SIN(T+PI*SIN(T))	Try it and see.

Table 1

samples have to be fetched for each cycle of the waveform it cannot generate very high pitch fundamental frequencies and the pitch of the note can only be specified in discreet steps.

These are fine for very low frequencies but for audio frequencies they tend to be a bit coarse. And with a real instrument the harmonic content of the note changes over the duration of the note.

This contributes a lot to the individual characteristic of an instrument's sound. All these problems can be solved with software but we will have to wait for next time to see how.

In the meantime have fun finding out what sounds you can make. See you next month.

THE BEEB BODY BUILDING COURSE

Component list for Body Build Pack 17: IC1–ZN428E–8 D/A converter. IC2 – LM324 quad op-amp. C1 – 1uF Tant. C2 to C5 – 10nF polystyrene 5%. C6 – 0.1uF disc ceramic. R1 – 390R. R2 – 15K. R3 to R7 – 5K6. R8 and R9 – 10K. R10 – 12K. R11 – 1K5. VR1 – 10K skeleton pot. 1 off 16 pin IC socket. 1 off 14 pin IC socket. 1 off 20 way IDC header plug. 1 off printed circuit board.

How to order

THIS month the complete pack costs only £20.85 (inc. VAT and postage). The printed circuit board alone may be bought separately for £8 (inc. VAT and postage).

The pack can also be supplied ready assembled for £26.85 (inc. VAT and postage).

The order form is on Page 158.

Audio Waveform Generator listing

```

10 DIM W(255),CODEX &100
20 PROC_INCODE
30 MODE 1
40 REPEAT
50 PRINT
60 PRINT"BEEB BODY BUILDING COURSE"
*
70 PRINT"OCTOBER 1984"
80 PRINT"By Mike Cook"
90 PRINT
100 PRINT"Audio waveform generator"
110 PRINT"Using the D/A converter"
120 PRINT
130 PRINT"Once you have defined a waveform"
140 PRINT"You can play it by pressing keys 1 - 9"
150 PRINT
160 PRINT"L - Will set the length of tone"
170 PRINT"D - Allows you to define the waveform"
180 REPEAT
190 PRINT
200 PRINT"F - Formular definition"
210 PRINT"C - Cursor keys definition"
220 A$=GET$
230 UNTIL A$="F" OR A$="C"
240 IF A$="F" THEN PROC_EVAL ELSE PROC_DRAW
250 PROC_WTRANS
260 PRINTTAB(33,1)"PLAY"
270 LX=5
280 REPEAT
290 F=GET
300 IF F>&2F AND F<&3A THEN PROC_PLAY(F,LX)

```

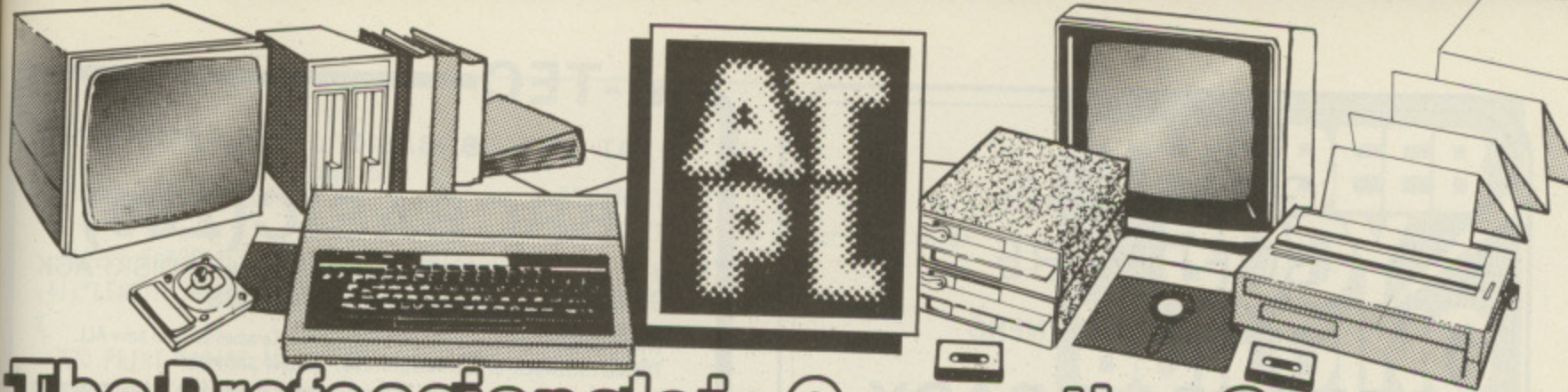

The Professionals in Computing Systems

We offer a design development and manufacturing service for companies wishing to improve their products using Microprocessor Technology.

COMPUTER DEALER ANNOUNCEMENT

ATPL have now become a computer dealer, by mail order, or direct selling, you are welcome to call and discuss any details of the products listed below, or alternately send an A4 S.A.E. to us for full Technical Data, and latest prices.

ATPL PRODUCTS

SIDEWISE BBC ROM expansion board.	£38.00
Battery back-up kit for CMOS RAM'S	£17.00
CMOS RAM 8K x 8bits. (6264LP5565PL)	£45.00
AUTOPROM EPROM programmer for the BBC.	£120.00
SIDEPROM EPROM programmer for BBC sideways ROM'S.	£86.00
OCTOPROM EPROM programmer blow 8 EPROM'S at once (BBC).	£297.00
INSIDEOUT extends one SW ROM socket out of the BBC.	£13.00
p + p	£1.00

ATPL DISC BASED SOFTWARE

SPOOLIT printer buffer on ATPL'S sideways RAM. (disc)	£12.50
TURBOPROM 1 fast programming Algorithm for AUTOPROM. (disc)	£12.50
TURBOPROM 2 Sideways ROM version of above. (ROM)	£15.00
DFS SHIFT moves DFS workspace to CMOS RAM on sideways. (disc)	£12.50
SIDESWIPE put sideways ROMS onto disc direct from the BBC.	£12.50
p + p	£1.00

OTHER PRODUCTS ON THE WAY

CIS a range of input/output modules and software for the BBC micro designed specifically as a teaching tool for application of microcomputers in industrial control. Emphasis is placed on the role of programmable controllers in industry. Price on application.

Other products are being developed all the time, an extension ROM to BASIC, a network system, extension switched mode power supply, and many more, please phone if you have a specific requirement.

ROBOGRAPHICS SYSTEM—COMPUTER AIDED DESIGN

ATPL are accredited dealers for the ROBOGRAPHICS CAD system. The most widely used system in the UK provides an ideal entry to computer aided design. A precision scale drawing general purpose 2-D draughting tool. Ideal for architecture, electrical and mechanical engineering, PCB design, control panels etc.

An APPLE based system;

ROBO500 general software/control pack. £295.00

ROBO1000 scale drawing software/control pack. £595.00

ROBO1500 precision drawing software/control pack. £1095.00

Supports most plotters.

Fully integrated system including computer, disc drives and A3 plotter from £3,603

Please call for details, demonstrations can be arranged.

carriage from £9.00

COMPUTERS

BBC Model B	£339.15
BBC Model B + disc interface	£396.65
BBC Model B + econet interface	£379.10
BBC Model B + disc + econet	£438.60
ACORN ELECTRON	£169.15
COMMODORE 64	£194.65
SINCLAIR SPECTRUM 48k	£110.00
carriage	£9.00

SECOND PROCESSORS

ACORN 6502	£169.15
ACORN Z80 + FREE SOFTWARE	£254.15
TORCH Z80 BOARD (phone for latest prices)	£254.15
TORCH DISC PACK (phone for latest prices)	£254.15
ACORN BIT STIK	£318.75
Carriage	£9.00

COMMUNICATIONS

ACORN Teletext adaptor	£191.25
PRISM Modem VTX5000 (SPECTRUM 48k)	£84.58
PRISM Modem VTX1000 (Basic hardwired)	£59.08
PRISM Modem VTX2000 (Software controlled)	£71.40
PRISM Communications pack (BBC rom)	£16.57
PRISM Communications pack (Cassette)	£12.33
Other modems are available, please phone for details.	
p + p	£2.50

JOYSTICKS

ACORN/BBC Joysticks	£11.48
SURE SHOT Centre loaded (Single stick)	£15.73
SURE SHOT Centre loaded (Twin)	£29.33
QUICK SHOT II (Atari type)	£10.63
WIZARD Interface (uses Atari stick)	£12.33
p + p	£2.50

CASSETTE UNITS

ACORN/BBC Data recorder	£25.07
COMMODORE C2N Cassette unit	£37.83
ACORN/BBC Cassette leads	£3.23
p + p	£2.50

DISC DRIVES PACE OR CUMANA

CSX100 100K 40T Single sided, double density	£145.64
CSX200 200K 80T Single sided, double density	£187.85
CSX400 400K 80T Double sided, double density	£210.16
CS 100 100K 40T S.S. D.D. + P.S.U.	£165.20
CS 200 200K 80T S.S. D.D. + P.S.U.	£204.30
CS 400 400K 80T D.S. D.D. + P.S.U.	£227.78

TWIN DISC DRIVES

CD 200 2x100K 40T S.S. D.D. + P.S.U.	£298.14
CD 400 2x200K 80T S.S. D.D. + P.S.U.	£377.32
CD 800 2x400K 80T D.S. D.D. + P.S.U.	£421.30
CD 400S 2x200K 80/40T DS DD PSU switch	£458.48
CD 800S 2x400K 80/40T DS DD PSU switch	£487.77
Other disc drives are available, please phone for details.	
carriage	£9.00

PRINTERS

EPSON	
RX80 100cps tractor only.	£272.72
RX80 FT 100cps tractor & friction.	£311.82
FX80 160cps tractor & friction.	£428.15
FX100 160cps 132 characters wide.	£556.20
SEIKOSHA	
5" 40cps dot matrix.	£117.30
GP100AS GP100A serial.	£182.75
GP500A 50cps 10" update of GP100A.	£211.65
GP550A 50cps friction & tractor.	£254.15
GP700A 7 colours 30 shade dot matrix.	£415.65
DAISY WHEELS	
BROTHER HR 13cps.	£430.10
SILVER REED EXP 500	£292.27
DAISY STEP 2000	£270.00
JUKI 6100	£381.65
Many other printers in stock, please phone for latest prices.	
carriage	£9.00

ACCESSORIES

Serial adaptor for EPSON printer.	£80.00
Automatic sheet feeders. From	£215.05
Tractor feeders. From	£78.20
All kinds of cables, for disc drive & printers.	
From	£8.00
Fanfold paper 2,000 sheets.	£11.90
Floppy disc's double density, single sided 48tpi.	£1.55
Floppy disc's double density, double sided 96tpi.	£2.43
Tape cassettes computer grade C10 or C12.	£0.40
p + p From	£1.00

COMPUTER UPGRADE KITS

Telephone for latest prices.

COVERS & CASES

PVC & Polyester covers for BBC, ELECTRON, COMMODORE etc.	From £3.00 to £36.00
Soft computer carry case.	£21.21
Hard computer carry case.	£42.26
p + p	£2.50

SOFTWARE & FIRMWARE

We carry full stocks of the following products;

BEEBLOG (allows authorised users only ROM). £12.75

COMPUTER CONCEPTS ROM'S

BEEBUGSOFT ROM'S + programs

ACORNROM'S + programs

RH ELECTRONICS programs

Buy any two products and get 10% off the retail price.

p + p £1.00

MICROVITEC COLOUR MONITORS for BBC, ORIC, QL, 480Z, NASCOM

14" & 20" screens 452 to 895 pixels in plastic or metal cases. From £199.00 carriage. £10.00

MICROVITEC COLOUR MONITORS for IBM, COMMODORE, SPECTRUM, APPLE, DRAGON

14" & 20" screens 452 to 940 pixels in plastic or metal cases. From £210.00 carriage. £10.00

DECCA COLOUR MONITORS PLASTIC CASE

14" standard & medium resolution, all with audio output, RGB/TTL or composite inputs. From £240.00 carriage. £10.00

MONO MONITORS

BBC 12" green screen. £88.83

PHOENIX 12" hi-res green screen. £97.75

Many other monitors in stock, please phone for latest details.

carriage. £10.00

SPECIAL PACKAGES

Buy a total computer package costing over £1,000 from ATPL and choose a free gift from the following:

1. Any computer concepts ROM under £40.00 retail.
2. An ATPL sideways ROM board, plus battery back-up kit.
3. 2 disc's of ATPL software.
4. 1 8K x 8bits CMOS RAM.
5. Take 2.5% discount from the VAT exclusive total retail price.

Other special packages are available, please phone we will quote you. We offer professional support to all our customer's.

p + p see under respective sections.

CABLE SERVICE

CENTRONICS parallel printer cables BBC	£9.90
DRAGON	£9.90
ORIC	£9.90
CBM64 (including software on cassette)	£19.90
SANYO	£14.90
IBM PC	£19.90
TRS 80	£14.90
SIRIUS VICTOR 2000	£14.90
DISC DRIVE & POWER CABLE FOR THE BBC.	
Signal cable single	£7.10
double	£10.74
Power cable single	£4.10
double	£7.80
dealer enquiries welcome very good discounts available.	
p + p	£0.50

I.C.'s FOR SALE TRY OUR PRICES

Example; 74LS244 £1.00

74LS245 £1.20

these are small quantity prices. Please phone your requirement for instant quotation on IC or MEMORIES.



Advanced Technology Products Limited

Station Road, Clowne, Chesterfield, S43 4AB. Telephone: (0246)

811585 (4 lines)

CONDITIONS OF SALE & DELIVERY

Cheques made payable to Advanced Technology Products Ltd. please allow 28 days for delivery. Cost of carriage or postage refer to each section. Quantity orders and overseas carriage charged at cost. Condition of sales available on request.



ACCESS AND BARCLAYCARD accepted. Carriage to be added to advertised price, then add VAT to the total.

GUARDIAN SOFTWARE

presents for DISC OWNERS

SOURCE LIBRARY MANAGER (SLM)

A new concept in ROM based software for the BBC MICRO

Features include:

- Stores and retrieves any amount of BASIC and/or ASSEMBLER source code, up to the full capacity of a disk (100k/200k).
- Creates a LIBRARY of up to 399 "members" per 80 track disk or up to 199 "members" per 40 track disk.
- Allows up to 99 versions of a single program or routine.
- Will simply and easily "construct" programs developed in a modular fashion.
- Stores fully documented code which can be "stripped" when required for execution.
- Uses 8 char names and 20 char description for each "member".
- Is fully menu-driven (i.e. no messy command syntax).
- Includes comprehensive manual and fitting instructions.
- Many other features too numerous to list here.

*** FULLY COMPATIBLE WITH 6502 SECOND PROCESSOR ***

IDEAL FOR BEGINNERS AND EXPERIENCED PROGRAMMERS ALIKE

PRICE £36 (incl. p&p) or large SAE for Fact Sheet to:

GUARDIAN SOFTWARE
21 Harvey Road, Walton-on-Thames,
Surrey KT12 2PZ.

M-TEC

AT LAST! BBCBASIC to run on YOUR CP/M Computer

BBCBASIC(Z80)

Now available for the TORCH and DISKPACK with full GRAPHICS

WHY STRUGGLE ON using OLD FASHIONED BASICs when you can have ALL THE ADVANTAGES OF BBCBASIC(Z80) on your computer?

Of course, we can't turn your computer's video display into a high resolution colour monitor, but we can give you all the other features of BBCBASIC including:-

- > LONG VARIABLE NAMES
 - > MULTI-LINE REPEAT UNTIL STATEMENTS
 - > MULTI-LINE NAMED FUNCTIONS
 - > MULTI-LINE NAMED PROCEDURES
 - > POWERFUL DIRECT MEMORY MANIPULATION USING THE INDIRECTION OPERATORS
 - > AN IN-LINE ASSEMBLER USING STANDARD Z80 MNEMONICS
 - > VERY SOPHISTICATED PARAMETER PASSING IN THE CALL STATEMENT
 - > SERIAL RANDOM AND INDEXED DISK FILES PLUS THE ABILITY TO ACCESS ANY BYTE IN THE FILE
 - > CLEAR SCREEN, TAB(X), TAB(X,Y), POS, VPOS and TIME
- Plus ALL THE OTHER STANDARD COMMANDS etc.

You can copy any program written in older 'standard' versions of BASIC with little change OR you can write well-structured and easy to read programs like a professional.

You need never say GOTO again. But we won't stop you.

Price, including postage, £95 + VAT

TORCH version including SOUND and GRAPHICS £110 + VAT
BBCBASIC(Z80) will run on any computer using CP/M 2.2 or later and a Z80 processor. It comes complete with an instruction manual, a tutor on file handling and configuration notes.

Trade enquiries welcome

M-TEC Computer Services (UK), Olands Road, Reepham, Norfolk

Telephone Norwich 870620

Prestel Mailbox Nos. 603870620

Datapen

BBC Lightpen Programs

Datapen

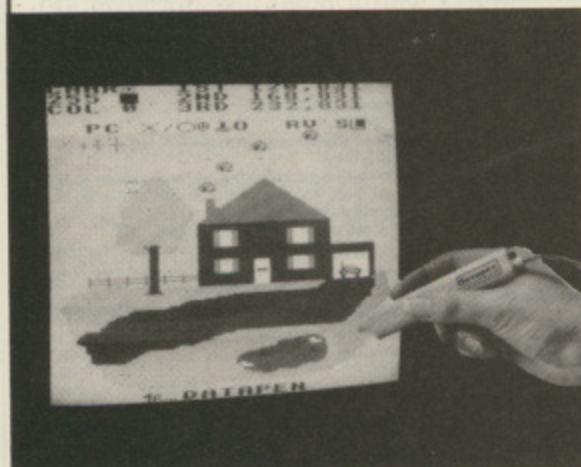

BEEB PEN DRAWING PROGRAM

A comprehensive Mode 2 colour drawing program allowing plot commands, painting, circles, text, character defining, saving and loading to tape or disc, all to be selected and used with the lightpen.

PRICE £11.95 Introductory Offer £9.95



TELETEXT DISPLAY CREATOR/EDITOR

Allows the busy programmer to quickly create Mode 7 colour graphics and test screens for combination into his or her own programs. Movable on screen menu allows use of complete screen for graphics. Full instructions and a discussion on teletext features are provided. PRICE £9.95 Introductory Offer £7.95



BRITAIN

The first in a series of educational Geography and Geology programs. Britain comes complete with three sets of tests, and these may be very easily changed by adding DATA statements in the Basic program. Full instructions and grid map supplied.

PRICE £6.95 Introductory Offer £5.95



SUPERIOR PERFORMANCE

- Insensitive to ambient lighting
- Responds to different colours
- Program accessible LED lamp readout
- Switch for program control

SUPERIOR PROGRAMS

- Tape storage of your work
- Good documentation
- User routines provided on tape and on printout

The Datapen Lightpen itself comes complete with handbook, software on tape including two drawing programs and a printed listing showing useful routines.

PRICE £25.00

Two drawing programs, SKETCH and SHAPE-CREATE are included with the lightpen and the programs shown above may be ordered additionally, or separately as required.

All prices above include VAT, postage and packing.

Please send your cheque/P.O. to:-

Dept. MU2 Datapen Microtechnology Ltd.
Kingsclere Road, Overton,
Hants. RG25 3JB

From Page 154

```

310 IF F=ASC("L") THEN PRINT TAB(33
,4);"LENGTH":PRINT TAB(34,5);:INPUT,L
%
320 PRINT TAB(33,4);SPC(6)
330 PRINT TAB(34,5);SPC(5)
340 UNTIL F=ASC("D")
350 CLS
360 UNTIL FALSE
370 END
380 DEF PROC_PLAY(P,DUR%)
390 AX=DUR%
400 IF P=&30 THEN P=&3A
410 X%=P-&30+14
420 Y%=0
430 CALL PNOTE
440 ENDPROC
450 DEF PROC_EVAL
460 PRINT
470 PRINT"Input the waveform expres
sion"
480 PRINT"In the form:-"
490 PRINT
500 PRINT"SIN(T)+0.3*SIN(T*3) .....
Ect."
510 PRINT
520 INPUT W%
530 PROC_AXIS
540 MAX=0
550 MIN=1024
560 CX=0
570 FOR T=0 TO PI*2 STEP PI*2/256
580 B=511+511*(EVAL(W%))
590 W(CX)=B
600 PLOT 5,CX*4,B
610 IF MAX<B THEN MAX=B
620 IF MIN>B THEN MIN=B
630 CX=CX+1
640 NEXT
650 IF MAX > 1023 OR MIN < 0 THEN P
ROC_SCALE
660 ENDPROC
670 DEF PROC_SCALE
680 PROC_AXIS
690 ADD=0-MIN
700 SCALE=(MAX+ADD)/1024
710 FOR AX=0 TO 255
720 W(AX)=(W(AX)+ADD)/SCALE
730 IF W(AX)=1024 THEN W(AX)=1023
740 IF AX=0 THEN MOVE 0,W(AX) ELSE
PLOT 5,AX*4,W(AX)
750 NEXT
760 ENDPROC
770 DEF PROC_AXIS
780 CLS
790 MOVE 1024,512
800 PLOT 21,0,512
810 ENDPROC
820 DEF PROC_DRAW
830 *FX4,1

```

```

840 PRINT
850 PRINT"Use the cursor keys to dr
aw the waveform"
860 AX=GET
870 PROC_AXIS
880 X%=0
890 Y%=520
900 GCOL 3,3
910 REPEAT
920 REPEAT
930 PLOT 69,X%,Y%
940 AX=GET
950 PLOT 69,X%,Y%
960 IF AX=139 THEN Y%=Y%+4
970 IF AX=138 THEN Y%=Y%-4
980 IF AX=136 AND X%<>0 THEN MOVE X
%,0:PLOT 7,X%,508:MOVE X%,516:PLOT 7,
X%,1024:X%=X%-4
990 IF Y% < 0 THEN Y%=0
1000 IF Y% > 1023 THEN Y%=1023
1010 UNTIL AX=137
1020 W(X%/4)=Y%
1030 PLOT 69,X%,Y%
1040 X%=X%+4
1050 UNTIL X%>1023
1060 *FX4,0
1070 PROC_DISP
1080 ENDPROC
1090 DEF PROC_DISP
1100 GCOL 0,3
1110 PROC_AXIS
1120 MOVE 0,W(0)
1130 FOR AX=1 TO 255
1140 DRAW AX*4,W(AX)
1150 NEXT
1160 ENDPROC
1170 DEF PROC_WTRANS
1180 FOR AX=0 TO 255
1190 AX?&A00=W(AX) DIV 4
1200 NEXT
1210 ENDPROC
1220 DEF PROC_INCODE
1230 FOR AX=0 TO 2 STEP 2
1240 PX=CODEX
1250 [
1260 OPT AX
1270 .PNOTE \ ACC A IS TIME X AND Y
IS THE TIME BETWEEN SAMPLES
1280 SEI \ DISABLE INTERRUPTS FROM S
YSTEM
1290 STA &70 \STORE NUMBER OF T2 TIM
EOUTS
1300 LDA #&E0
1310 STA &FE6E \ ENABLE THE TWO TIME
RS
1320 LDA #&FF
1330 STA &FE68
1340 LDA #&40
1350 STA &FE69 \ SET UP TIMER 2
1360 STX &FE66 \LOW ORDER BYTE
1370 STY &FE67 \HIGH ORDER BYTE

```

```

1380 STX &FE64
1390 STY &FE65 \START TIMER T1
1400 LDX #0
1410 .LOOP
1420 LDA &FE6D \LOOK AT THE INTERRUPT
T REG
1430 BPL LOOP \BRANCH IF NO TIME OUT
YET
1440 LDA &A00,X \GET NEXT SAMPLE OF
THE WAVEFORM
1450 STA &FE60 \OUTPUT IT TO THE D/A
CONVERTER
1460 INX
1470 LDA &FE64 \RESET INTERRUPT FLAG
WITH A READ
1480 LDA &FE6D \LOOK AT THE INTERRUPT
T REG
1490 BPL LOOP \BRANCH IF T2 HAS NOT
TIME OUT
1500 LDA #&7F
1510 STA &FE6D \RESET ALL INTERRUPT
FLAGS
1520 LDA #&FF
1530 STA &FE68 \RE PRIME TIMER 2
1540 LDA #&40
1550 STA &FE69
1560 DEC &70 \TAKE ONE OFF THE NUMBE
R OF T2 TIMEOUTS
1570 BNE LOOP \ BACK IF WE HAVE NOT
FINISHED
1580 LDA #&60
1590 STA &FE6E \ DISABLE THE TWO TIM
ERS
1600 LDA #123
1610 STA &FE60
1620 CLI \ ENABLE SYSTEM INTERRUPTS
1630 RTS
1640 ]
1650 NEXT
1660 ?&FE62=&FF : REM SET UP VIA AS
ALL OUTPUTS
1670 ?&FE6B=&40 :REM SET UP TIMER MO
DES
1680 ENDPROC

```

This listing is included in this month's cassette tape offer. See order form on Page 217.

Make light work of it

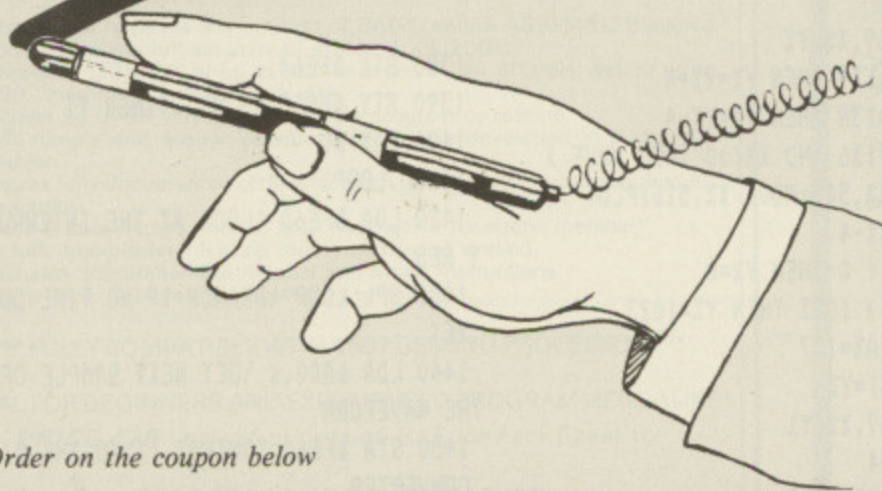

Order on the coupon below

USING a lightpen really DOES make light work of entering data into your BBC Micro.

Painting on the screen or selecting options comes naturally with *The Micro User* lightpen.

Children in particular find it easy to communicate with a micro this way.

With our ready-assembled lightpen comes full details of how to use it in your own programs PLUS three pieces of software to get you started:

- **Pentest** – to set things up for your own micro.
- **Pendraw** – an enthralling painting program.
- **Penbell** – an entertaining musical diversion.

All in all, *The Micro User* lightpen is a really versatile add-on for your BBC Micro, with lots of possibilities.

We'll be publishing lots of interesting applications for the lightpen in forthcoming editions of *Micro User*. But if you simply can't wait, incorporating a lightpen in your own programs is simplicity itself.

And when you've done it, why not send us the results – you could become one of our authors!

Upgrade your BBC Micro with these Beeb Body Building Packs.

- **Packs 1 and 2:** These packs let you safely and simply interface your micro to the outside world.
- **Pack 3:** Give your Micro data-processing muscle by building a dual cassette system.
- **Packs 4 and 5:** Control mains equipment in complete electrical isolation. Pack 4 is rated at 4 amps, pack 5 at 10 amps.
- **Pack 6:** All the components for the *Micro User* light pen.
- **Pack 7:** Experiments to investigate pendulum behaviour and capacitor discharge.
- **Pack 8:** A versatile sound to pattern converter with many applications.

What the Beeb Body Building packs contain

- **Pack 9:** Remember all those vital appointments with the help of this real time clock.
- **Pack 10:** A high speed A/D with many applications. For instance, turn your microcomputer into an oscilloscope!
- **Pack 11:** A pulse rate monitor. Ideal for keep-fit fanatics and experimenters alike.
- **Packs 12 and 13:** Components to control stepping motors in two different ways. Pack 12 uses the

micro to control the stepping sequence. Pack 13 uses a dedicated chip.

- **Pack 14:** Turn your micro into a communications terminal by building an acoustically coupled modem. (Handset retainer not included.)
- **Pack 15:** Add the tremendous power of 4 extra User Ports to your BBC Micro.
- **Pack 16:** The ribbon cable and socket needed for pack 15.

- **Pack 17:** All you need to make a digital to analogue converter (programmable as a waveform synthesiser). You'll also need a ribbon cable (such as in pack 2). Also available are a full-assembled light pen, sound-to-pattern converter, real time clock, pulse monitor and digital to analogue converter. For a small extra charge constructors who run into difficulty assembling pack 8 can send it in for testing. It will be returned fully operational.

YOUR ORDER FORM

for the Beeb Body Building packs

Please send me:	Described in issue	No.	Amount
Pack 1 @ £9.95	July 1983 page 83	<input type="checkbox"/>	£
Pack 2 @ £9.95	July 1983 page 83	<input type="checkbox"/>	£
Pack 3 @ £9.95	August 1983 page 85	<input type="checkbox"/>	£
Pack 4 @ £9.95	Sept 1983 page 91	<input type="checkbox"/>	£
Pack 5 @ £12.95	Sept 1983 page 91	<input type="checkbox"/>	£
Pack 6 @ £13.65	October 1983 page 69	<input type="checkbox"/>	£
Pack 7 @ £15.50	November 1983 page 71	<input type="checkbox"/>	£
Pack 8 @ £16.55	December 1983 page 95	<input type="checkbox"/>	£
Pack 9 @ £28.50	February 1984 page 123	<input type="checkbox"/>	£
Pack 10 @ £24.95	March 1984 page 132	<input type="checkbox"/>	£
Pack 11 @ £19.00	April 1984 page 118	<input type="checkbox"/>	£
Pack 12 @ £24.95	May 1984 page 148	<input type="checkbox"/>	£
Pack 13 @ £29.45	May 1984 page 148	<input type="checkbox"/>	£
Pack 14 @ £59.95	July 1984 page 115	<input type="checkbox"/>	£
Pack 15 @ £44.95	August 1984 page 117	<input type="checkbox"/>	£
Pack 16 @ £8.25	August 1984 page 117	<input type="checkbox"/>	£
Pack 17 @ £20.85	October 1984 page 149	<input type="checkbox"/>	£
Assembled light pen @ £18.35		<input type="checkbox"/>	£
Assembled sound to pattern converter @ £22.30		<input type="checkbox"/>	£
Assembled real time clock £31.00		<input type="checkbox"/>	£
Testing sound to pattern converter @ £9.70		<input type="checkbox"/>	£
Assembled pulse monitor @ £25.50		<input type="checkbox"/>	£
Assembled digital to analogue converter @ £26.85		<input type="checkbox"/>	£
			£1.00*
All prices include VAT			
Cheque to be made payable to Database Publications			
		Total	£

Name

Address

POST TO: BBB Packs, Micro User, Europa House, 68 Chester Road, Hazel Grove, Stockport SK7 5NY.

Please allow up to 28 days for delivery

COLOURJET

36 COLOUR INK JET PRINTER

Prints all BBC Micro
screen Modes inc.
Mode 7 . . . in full colour

£550 (Rec. price excl. VAT)

With Centronics parallel interface
and free BBC Micro dump listing.

Prints overhead transparencies

Options available:

- Buffered RS232 interface.
- Viewdata & RS232 interface.
- Apple II interface.
- IBM PC dump.

Specifications:

640 dots/line + 1280 dots/line high res mode.

Double strike mode.

84 dots/inch both axes.

Friction feed rollpaper with single sheet feed A4.

40cps in full colour.

Ink cartridges, 4 million character life.



from BBC Micro screen - 1/2 size mode



Virtually
silent



INTEGREX LTD.

Burch Gresley, Burton-on-Trent, Staffs DE11 9PT
Tel: 0283 215432 Telex: 377106

Dealers, OEM & Educational
enquiries welcome

Unless you have a sideways ROM board, every time you want to change a ROM you have to delve inside your BBC Micro. Constantly replacing ROMs can also damage their delicate pins. MIKE SMITH gives a simple do-it-yourself answer to both problems.

As supplied, the BBC Micro can physically accommodate only three additional applications ROMs. If future ROM changes are contemplated, careful surgery has to be applied. Even so, this may put the hardware at risk.

So far the solution has been to add a sideways ROM board – complete with associated decoding – to allow expansion up to 16 ROMs. While it is certainly convenient to have the most frequently used ROMs permanently in place, for many applications selecting “ROM of the day” is just as convenient.

With this in mind, plus a few minutes browsing through a bits catalogue, the simple single ROM socket idea was born.

It was simply a matter of making one of the internal ROM sockets accessible on the front of the machine. That dotted box alongside the keyboard was just asking to be cut out anyway.

For the selected ROMs to survive repeated insertions, a zero insertion force (ZIF) socket is essential. This is a lever-operated device that closes onto the ROM pins after it has been dropped into place.

Mounting the socket into the machine is not unduly difficult, but does require the addition of a mounting arrangement to the keyboard panel.

Examination of the panel reveals little scope for drilling holes, and consequently any add-on hardware has to be mounted from the lower left corner.

The following constructional details supplement the diagrams of the completed assembly.

- Make the bracket and pillar as detailed in Figure I.
- Remove the four screws retaining the top cover of the ZIF socket, remove cover and operating lever.
- Drill 10BA clearance holes through the depressions at each end of the socket.
- Remove the top cover of the micro. Using the top cover of the ZIF socket,

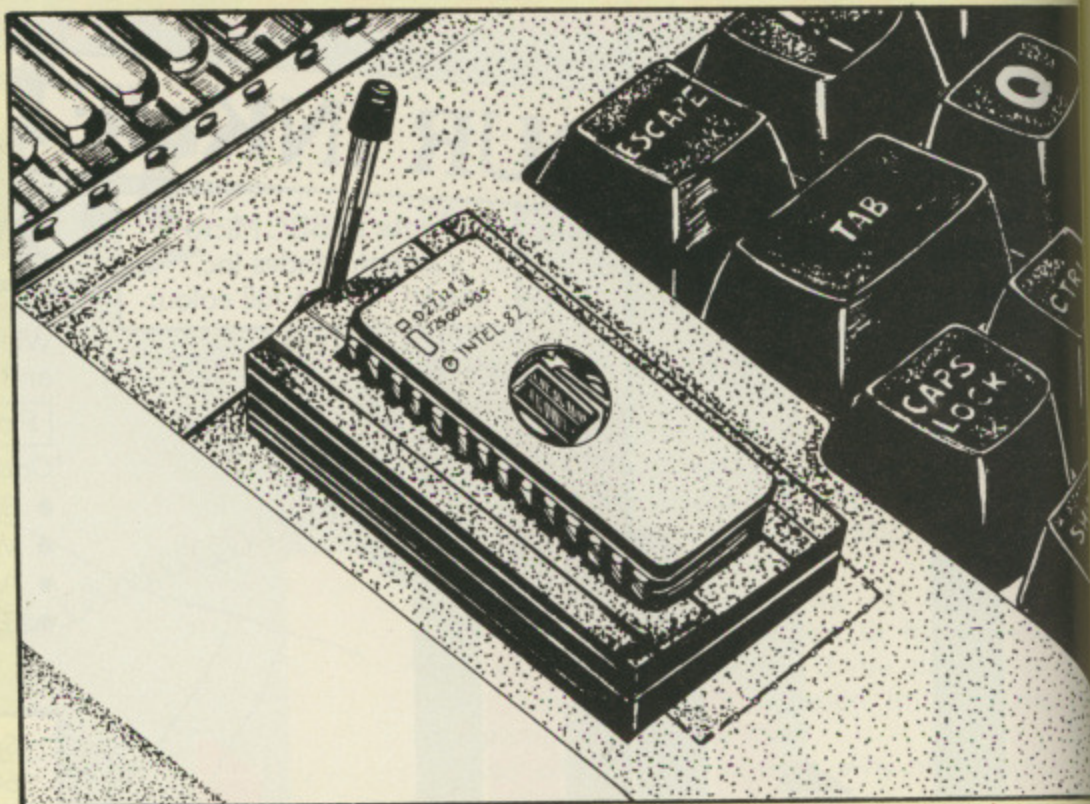

Socket to your micro

mark the outline for cutting, as shown in Figure II. Cut away plastic until a clearance fit is obtained.

□ Remove keyboard panel, taking care not to deform the connectors. Cut away about 1mm from the cross rib of plastic adjacent to the power supply, of width equal to the 28 way ribbon cable. A scalpel is all that is required on the soft plastic.

□ Drill a 3.5mm hole in the keyboard panel. Dimensions are shown in Figure I.

□ Fit bracket and pillar assembly to keyboard panel with 3mm screw and shakeproof washer. (The bracket should be given a slight downward bend to ensure that the leg bears on the panel.)

□ Place keyboard and machine's cover into position (no need to fasten anything yet!). Place the ZIF socket on to the bracket through the aperture, and mark the fixing positions through the 10BA holes onto the bracket.

□ Remove cover and bracket. Drill 10BA clearance holes at positions marked. Fasten ZIF socket to bracket with 10BA fastenings. Replace operating lever and top cover of ZIF socket.

□ The next stage is to connect the ZIF socket to the sideways ROM socket. Since I was unable to locate a 28 way insulation displacement connector plug, a 40 way plug was used, and carefully cut to 28 way after pressing onto the ribbon cable. Remember that the wire numbers out of the insulation displacement plug now alternate 28; 1; 27; 2; etc. The diagram shows the routing of the ribbon cable through the machine.

□ The other end of the ribbon cable is now formed into place, cut to length, and connected pin-for-pin to the ZIF socket.

□ Mount the socket and bracket onto the pillar, again using a shakeproof washer. Form the ribbon cable into the well at the left of the keyboard, and plug the IDC into a ROM socket.

□ Fasten keyboard and cover into place, adjusting the bracket angle if necessary.

Well, that's it, constructionally speaking. The only things that require special attention are the assembling of the IDC plug on the ribbon cable, and ensuring that there is pin-to-pin connection accuracy with no loose

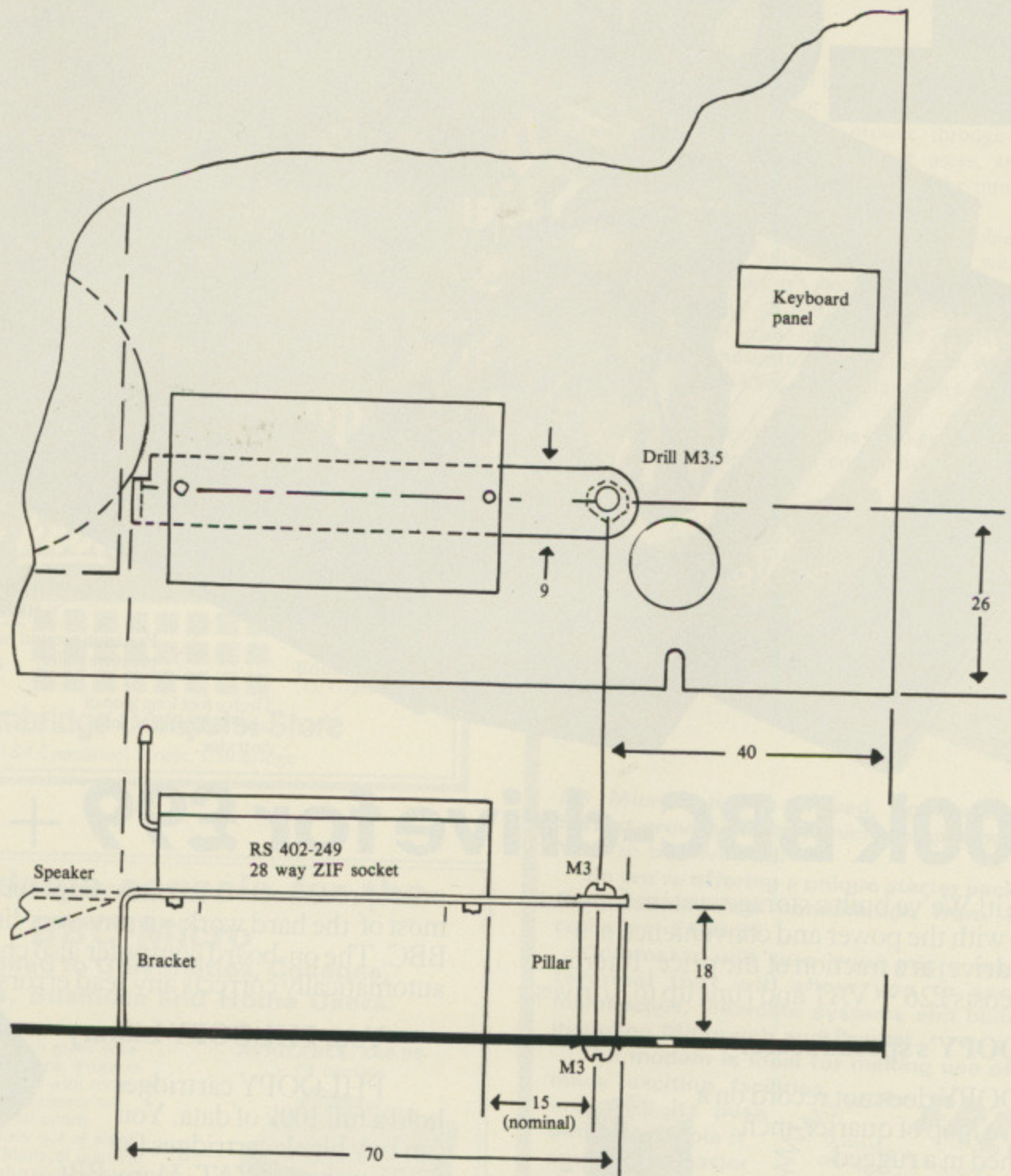

Basic fixing details of 28 way ZIF socket onto keyboard panel.

Socket support:
5mm x 0.8mm steel folded to form 18mm leg.
One corner notched to accommodate speaker.

Pillar:
Nylon spacer cut to 18mm.
Takes M3 screws.
All dimensions in mm.

Figure I

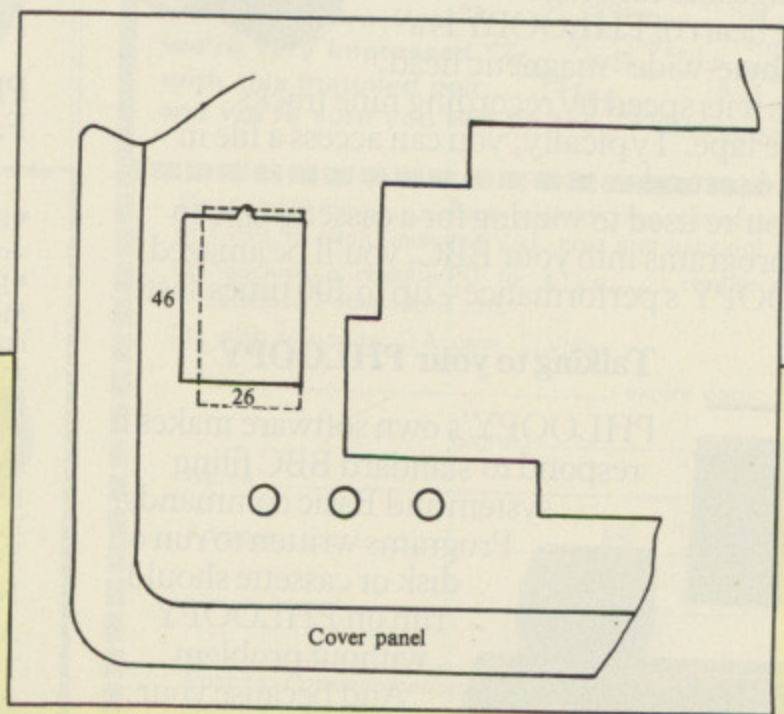

Figure II

the ZIF socket. 28 way for plug, carefully onto the wire displace-; 27; 2; putting of machine. cable is length, the ZIF

connections or shorts between adjacent pins.

It only remains to select ROM-of-the-day, plug in (the right way up, of course) and power up your new toy! Although I've not experienced any problems putting in a ROM with the machine switched on, it's not good practice and should be avoided.

YES!



A 100k BBC-drive for £99 + VAT

We've done it! We've built a storage system for your BBC Micro with the power and convenience of a floppy disk drive, at a fraction of the price. Interface to the BBC costs £26 + VAT and runs up to 8 drives.

PHLOOPY's special secret

PHLOOPY does not record on a disk, but on a loop of quarter-inch tape contained in a rugged interchangeable cartridge.

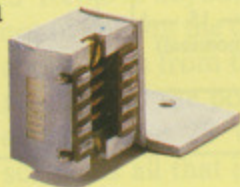

The heart of PHLOOPY is a unique "byte-wide" magnetic head, that gives it its speed by recording nine tracks across the tape. Typically, you can access a file in only 3 or 4 seconds.

If you're used to waiting for a cassette tape to trundle programs into your BBC, you'll be amazed at PHLOOPY's performance – up to 100 times faster.

Talking to your PHLOOPY

PHLOOPY's own software makes it respond to standard BBC filing system and Basic commands. Programs written to run on disk or cassette should run on PHLOOPY without problem. And because your PHLOOPY drive contains its own

microprocessor – a second computer which does most of the hard work – it puts very little load on the BBC. The on-board computer also checks and automatically corrects any read errors.

Your PHLOOPY Library

PHLOOPY cartridges hold a full 100k of data. You can buy blank cartridges for £3.75 each plus VAT. Many BBC programs will be available on PHLOOPY.



Phi Mag Systems Ltd. PO Box 21, Falmouth, Cornwall TR11 3TD Tel: (0326) 76040

Order Form

- Please send me further details about the PHLOOPY 100k data storage system for the BBC Model B.
 - Please send me _____ (qty) PHLOOPY starter pack(s) for my BBC Model B microcomputer, including PHLOOPY drive, BBC interface, leads, connections, operating system in firmware, manual, and two PHLOOPY 100k cartridges, at £147.75 each including VAT, postage and packing. Amount £ _____
 - Please send me _____ (qty) packs of 5 PHLOOPY cartridges at £19.75 including VAT, postage and packing. Amount £ _____
- I enclose a cheque/PO for £ _____ OR Please debit my
Access card Number: _____
Your order will be acknowledged within 10 days, giving a delivery date

Name _____
Address _____
Town: _____ Post code _____
Send this coupon to: Phi Mag Systems Ltd, PO Box 21, Falmouth, Cornwall TR11 3TD. Telephone: Falmouth (0326) 76040.
14 day money-back option.

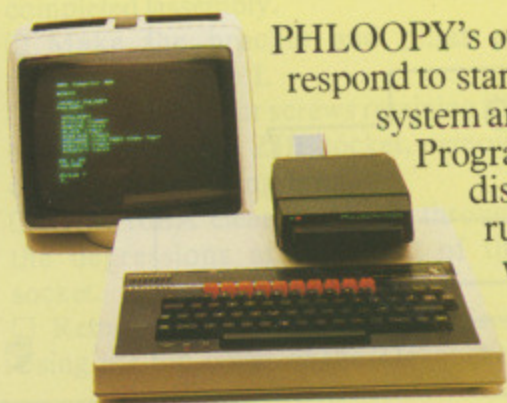

1 Bus Pro Tel 0

Ex

Not just expansion micro th and enc disc driv teletext connect within t strong a in match a bolt for furth console Basic B £4 carr Bolt on £14.99

ELEC The con and wil interfac of the r at eye between The cor tapes a a later Electro £34.99

Sil COR

"On-board" microprocessor.

4

Emmanuel St.

Our new Personal Computer Centre specializing in the BBC Micro with complete support

we know computers

1 Business & Professional
Tel: 0223 65335/4



Home & Educational 4
Tel: 0223 358264

Cambridge Computer Store

1 & 4 Emmanuel Street, Cambridge

Expandable console for the BBC Micro

As supplied to Universities, Colleges, Schools, Business and Home Users.

Not just a monitor/tv stand but an expansion console which gives your micro the professional look. Protects and encloses your micro with room for disc drives and 2nd. processor or teletext adapter etc., all untidy connecting wires safely out of sight within the console. Made of light yet strong aluminium with a textured finish in matching BBC colour. Available now a bolt on extra module to the console for further expansion options. YES this console will grow with your needs. Basic BBC console as shown £44.99 + £4 carriage.

SPECIAL TORCH MODEL AVAILABLE: £46.99 + £4 carriage

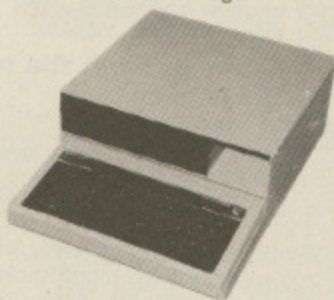

Bolt on expansion module £14.99 + £2 p&p

Matching Printer Stand, can double for VDU Stand over the micro - only £14.99 + £2 carriage

ELECTRON CONSOLE

The console will house the ELECTRON and will safely support the expansion interfaces which will plug into the rear of the micro and will support the VDU at eye level. Tidies up all wiring between the micro, cassette and VDU. The console stores the cassette and tapes and will allow space for drives at a later date.

Electron console as shown £34.99 + £3 p&p

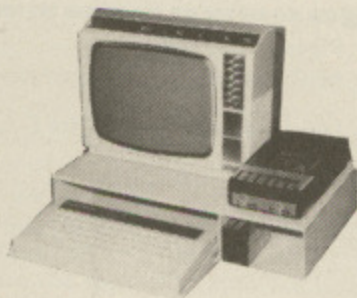

Mail order only - viewing by appointment

Please add 15% VAT.

For further information or send cheque to:

Silent COMPUTERS

27 WYCOMBE ROAD, LONDON N17 9XN.
TEL: 01-801 3014 (24 Hr Ansaphone)



061-456 4157

... that's the number you'll need for Microweb, the most exciting bulletin board around for the BBC Micro.

On Microweb you can browse through the hundreds of fascinating messages left by other users, and add your own contributions - you'll be amazed by the number of interesting people you'll come across on the board.

You can have your programming problems answered by experts, download software, and catch up with the latest news.

In the few weeks it's been in existence it has become the ultimate forum for all BBC Micro users.

So if you want to join in the liveliest conversation ever between BBC Micro enthusiasts why not log on? We'll be glad to hear from you. All you have to do is dial in via a 300 baud modem with suitable software.

And if you're looking for the kit to get you started, why not try Pace's Commstar/modem combination?

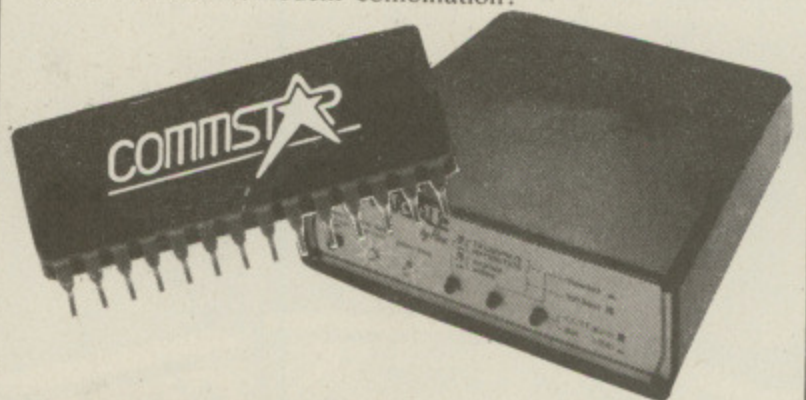

AS Microweb has proved, communications is the fastest growing field in microcomputing, and we want YOU to be involved.

So we're offering a unique starter pack - the superb Commstar/modem combination from Pace. And it costs just £139.95.

Commstar will turn your micro into a versatile terminal that will allow you to access micros, mainframes, viewdata systems and bulletin boards - including Microweb and Prestel.

The modem is ideal for making use of Commstar's many exciting facilities, and with its push

button controls it couldn't be easier to use.

At the Micro User we're very impressed with this matched pair, and we're sure you will be too.

FREE!

8 weeks' introductory membership of Prestel/Micronet will be given to all readers whose orders are postmarked before October 1, 1984.

Please send me _____ Communications packs at the total price of £139.95 each (includes VAT, post and packing).

I enclose a cheque/PO for £ _____ made payable to Database Publications Ltd.

I wish to pay by Access Visa

No. _____ expiry date _____

Signed _____

Name _____

Address _____

Post to: Communications Offer, Database Publications Ltd, Europa House, 68 Chester Road, Hazel Grove, Stockport SK7 5NY.

Please allow 28 days for delivery

REGARDEZ

LANGUAGE LEARNING AIDS FOR
FRENCH, GERMAN & SPANISH

FOR BBC(32K) · ELECTRON
SPECTRUM (48K)

As used in numerous schools and colleges these programs provide a highly successful aid to modern language learning. Each cassette contains a sophisticated control program and a comprehensive series of vocabulary lessons which can be used in a variety of self-paced learning and test modes. Words, phrases etc are displayed with all necessary accents and special characters, different colours are used for masculine, feminine and neuter words to assist gender learning.

The programs are suitable for beginners, 0-level and beyond as simple commands enable new lessons in vocabulary or grammar to be created by the user, edited as required, then permanently saved for later use. Invaluable for homework and exam revision!

Two cassettes are available for each language, together these contain a vocabulary of thousands of words; Level A provides 16 lessons in general subjects; Level B provides a further 16 lessons including adjectives, adverbs and fully conjugated verb lists.

Available from your computer store or by mail order Price £9.95
Also Available "ANSWER BACK General Knowledge Quiz" Price £10.95



W W S O F T W A R E

KOSMOS Software 1 Pilgrims Close, Harlington, DUNSTABLE, Beds. LU5 6LX
Telephone (05255) 3942

Please supply the following programs

- | | |
|--|--|
| The French Mistress Level A @ £9.95 <input type="checkbox"/> | The French Mistress Level B @ £9.95 <input type="checkbox"/> |
| The German Master Level A @ £9.95 <input type="checkbox"/> | The German Master Level B @ £9.95 <input type="checkbox"/> |
| The Spanish Tutor Level A @ £9.95 <input type="checkbox"/> | The Spanish Tutor Level B @ £9.95 <input type="checkbox"/> |
| ANSWER BACK Quiz (Senior) @ £10.95 <input type="checkbox"/> | |

I have a BBC/Electron/Spectrum computer (delete as necessary)

Mr/Mrs/Miss.....

Address

Post code

I enclose a cheque/postal order for £..... payable to KOSMOS Software

KOSMOS SOFTWARE
1 Pilgrims Close, Harlington, DUNSTABLE, Beds. LU5 6LX

Disc Drive Multiplexer

- * No switches
- * No software
- * No extra cables or connectors

This is a very simple low cost alternative to buying a disc drive for every BBC machine. This unit allows up to 4 BBC computers to access the same single or dual disc drive using the standard DFS commands. The unit operates by electronically switching the disc interface signals. The multiplexer copes with simultaneous access and will run with one or more BBCs disconnected or turned off. The unit is ideal for use in schools and offices and saves having to purchase several drives for up to £500 each.

The unit is complete with 5ft. cables as standard but cables up to 10ft. can be supplied. The multiplexer has its own power supply.

Prices: £75.00 for a dual unit with 2 x 5ft. cables
£135.00 for a quad unit with 4 x 5ft. cables
Plus 15% V.A.T.
Postage & packaging £1.50
Extra cable at 60 pence per foot.

VIA Board

This extension board gives the user 3 extra VIAs (equivalent to 6 user ports). The connection is made to the 1MHz Bus and the VIAs can be decoded to appear in pages & FC & FD. Up to 4 boards can be daisy chained to give 12 VIAs.

The board can be powered from +5v, +12v DC or 9v AC.
Price £60.00 each plus 15% V.A.T.

All products will be supplied on a Sale or Return basis to Schools, Colleges and Government Departments.

For further details contact:
BENWICK ELECTRONICS
5 Church Street, Wimblington, Nr, March, Cambs.
PE15 0QS
Tel: March (0354) 740508

SUPERB HARD COVERS for your BBC Micro & Electron

- * Engineered in top quality high impact ABS - very tough
- * Super textured finish in cream to tone with your BBC Micro
- * Looks good in the home
- * Gives excellent protection
- * Ideal for schools and colleges

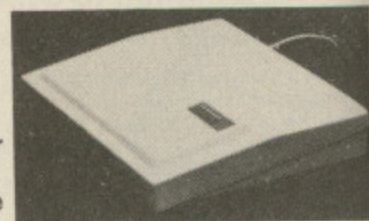

BBC Cover: £10.95
(+£1.55 P&P)
Electron Cover: £8.95
(+£1.00 P&P)

TOP QUALITY MONITOR STAND

A high quality steel stand designed to combine a pleasing appearance with high rigidity. It bridges the BBC Micro and can be used with our hard cover. It has solid rubber feet and has a durable stove enamelled textured finish to match the BBC Micro. Platform dims. 455mm x 260mm. Overall height 105mm. Price: £17.95 (+£2.00 Post & Packing).

Please send me

BBC covers Electron covers Stands

I enclose a cheque/P.O. for £.....

Name

Address

Code

MU5

Send to: **Tekform Products**
Grange Close
Sandbach
Ches. CW11 9ET
Tel: (09367) 3098

Tekform

THE following short program came about while writing a small machine code game for my children.

Being something of a novice I didn't know how to output decimal numbers from the machine code so I decided to let Basic do it.

Using ? and ! was inexorably slow, so I decided to write directly to the integer variables and print them out instead.

Fine, but where are they stored? After much delving into back issues of *The Micro User*, I eventually came up with the following program:

```
10 base=&400
20 FOR integer=0 TO 26
30 PRINT ~(base+integer*4);" ";
40 PRINT CHR$(64+integer);
   CHR$(37);" ";
50 PRINT ~!(base+integer*4)
60 NEXT
```

This is the program structure;

- 10 Integer variables are stored from &400-&472 so set *base* to &400.
- 20 There are 27 integer variables A%-Z% + @%, so the FOR...NEXT loop gives an offset from 0 to 26.
- 30 Each variable is stored as four bytes in memory, hence their

Write directly to integer variables - it's a lot quicker than plinging!

By **MARCUS ADAMS**

location is given by *base + integer * 4*.

- 40 *CHR\$(64) + integer* gives the Ascii character corresponding to the variable's name, for example *CHR\$(64) + 2 = "B"* and *CHR\$(37)* is a %

- 50 Uses the indirection operator to PEEK the value of the variable. Default output of the routine is in hex but this can be changed by removing the '~'.

The program has been expanded here for clarity, but can just as easily be put onto one line or in a function key.

Also, by replacing line 50 with:

```
~!(base+integer*4)=0
```

all of the resident integers can be set to zero or any other number you choose.

What the competition hasn't been waiting for.

Latest version of Forth for the BBC (Is not rehased Forth 79 Code)

Unique Stack Display Utility



16k Eprom type 27128

Multi-tasking operating system for Real-Time use.

Here's the Forth Eprom for the BBC Micro that makes all others out of date.

It's Multi-Forth 83 from David Husband who has built his reputation for Quality Forth products with his ZX81-Forth ROM, Spectrum Forth-I/O Cartridge and now New Multi-Forth 83 for the BBC Micro. This is not rehased Forth 79 Code, but a completely new version of the Forth 83 Standard. It's unique in that it Multi-tasks, and therefore the user can have a number of Forth programs executing simultaneously and transparently of each other.

Multi-Forth 83 sits in the sideways ROM area of the BBC along with any other ROMs in use. It is compatible with the MOS, and specially vectored to enable a system to be reconfigured. It contains a Standard 6502 Assembler, a Standard Screen Editor, and a Unique Stack Display Utility.

With this Forth, David Husband has provided the BBC Micro with capabilities never before realised. And being 16K rather than 8K is twice the size of other versions. Multi-Forth 83 is supplied with an

extensive Manual (170 pages plus) and at £40+VAT it is superb value.

Order it using the coupon adding £2.30 p&p (£5 for Europe, £10 outside) or if you want more information, tick that box instead. Either way, it will put you one step ahead of the competition.

Please send me Multi-Forth 83 for BBC Micro. £40+VAT De-luxe System inc. Disc £80+VAT. Cheques to Skywave Software Readers' A/C (or enter Visa No.)

BMU/10

Please send me more information:

Multi-Forth 83

ZX81-Forth ROM

Spectrum Forth-I/O Cartridge

Name _____
Address _____
Post code _____
SUBJECT TO AVAILABILITY. FOR I.O.S. ONWARDS.
Send to Skywave Software, 73 Curzon Road, Bournemouth,
BH1 4PW, Dorset, England. Tel: (0202) 302385



MULTI-FORTH 83 FOR THE BBC MICRO

What has the latest Electron User got for BBC Micro users?

The answer's simple ...

LISTINGS!

Pages and pages of them. Games, graphics demonstrations, utilities, they're all there. Also there are hardware reviews, hints and tips, regular features like Casting Agency and Sounds Exciting, Pete Bibby's beginners articles and the graphics series.



All Electron User listings will work on BBC Micros with OS 1.2 and Basic II. Even with Basic I machines and earlier OSs the vast majority of the programs will work without modification.

October sees the start of a great new series exploring the Electron's SOUND command. There's also a sound generator from Roland Waddilove, to help you create your own noises. Arcade game freaks will find all the action they crave in Breakfree while Alphaswap gives the more cerebral something to think about. Our reviewers assess the First Byte printer interface and Acornsoft's FORTH while the beginners article concludes the FOR...NEXT saga. With a multicharacter generator, a palindrome tester and yet more sideways scrolling, it's the best issue yet.

Now on sale at your newsagent!



Proudly presents
**CHESS ANALYSIS
SYSTEM (CAS)**

CHESS DATABASE for the BBC Model B (OS 1.2)

- EASY TO USE structured database.
- MOVES, VARIATIONS AND COMMENTS in a file.
- ANY NUMBER OF GAMES in a file.
- START GAMES from any position.
- MANY REPLAY OPTIONS include: AUTOMATIC RESET to selected position; JUMP backwards and forwards in a game; TEST YOURSELF against the data file.
- LARGE DISPLAY of board and pieces showing current position.
- You can use CAS to: BUILD AND UPDATE your personal opening system; RECORD AND ANALYSE games including POSTAL CHESS games with dates; ANALYSE POSITIONS, e.g. analyse variations on adjourned games.
- UPTO 2000 MOVES in a file.
- EDITOR to update files.
- AUTOMATIC game index.
- SAVE to tape or disk.

In addition CompuChess provides data files containing instructional and reference material for use with CAS. Many more will follow.

CHESS AUTHORS We are seeking chess material suitable for publication in data files. No programming knowledge is needed! We are also seeking a strong machine code chess playing program. Excellent royalties will be offered.

ALL GOODS DESPATCHED WITHIN 5 WORKING DAYS. PLEASE SEND ORDER & CHEQUE/P.O. TO **COMPUCHES, Horndale Avenue, Aycliffe Industrial Estate, Co. Durham DL5 6DR.** Tel: (091) 2854325. Educational & dealer enquiries welcome. VAT No. 257 8710 30.

Name _____ Cheque/P.O. for _____

Address _____

Post code _____

Please tick boxes as appropriate

CHESS ANALYSIS SYSTEM 40 track disk 80 track disk £11.95

CHESS ANALYSIS SYSTEM Tape version £9.95

TAPE TO DISK UPGRADE Send old tape £5.00

DATA FILES: Benoni French

Queens Gambit Declined Queens Indian

Kings Indian Grunfeld

Nimzo Indian Sicilian

} £2.95* each

*3 or more only £2.50 each. Supplied on tape but CAS allows disk users to transfer data files easily to disk. OR add £2.00 to supply all data files on a single disk. Please state whether 40 track or 80 track

Price inc. VAT & P&P

Educational Software **LCL**

**MICRO
ENGLISH**



A COMPLETE ENGLISH LANGUAGE COURSE
OF 24 EASY TO USE PROGRAMS **LCL**
FOR 'O'LEVEL SELF-TUITION OR REVISION

**BBC Micro
ZX Spectrum
unexpanded VIC
Electron
ZX81
Apple
PET
Commodore 64
Dragon (book only)
All software for the
above computers.**



MICRO ENGLISH (BBC, Electron) complete English Language O-Level self-tuition or revision course of 24 programs, 2 disks/tapes. £24.50.

MICRO MATHS 24 program revision or self-tuition course to O-Level. £24.50 (except ZX81 £12.00).

BRAINTEASERS (BBC, Electron, CBM 64, Spectrum, Dragon, Vic) £5.95. "The book is a collection of 29 program listings, each one an interesting and amusing challenge... You'll like this" **ELECTRON USER**

ANIMATED ARITHMETIC Teaches using moving colour pictures (not words) Ages 3-8 £6.50 (disc £7.50).

MASTER MATHS (Apple, Pet and CBM 64 only). 50 program O-Level course or teacher's aid, amazing graphics. "... the programming standard is high". **TIMES EDUCATIONAL SUP.**

Immediate dispatch of Micro English, Micro Maths, and Master Maths. Phone or send orders or requests for free catalogue (200 programs) to:

LCL
26 Avondale Ave.
Staines, Middx.
Tel: 0784 58771
24 hrs. Orders

World leaders in Educational software.

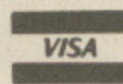

**GENEROUS TRADE
DISCOUNTS.**

SPECIAL REDUCTION
DISC DRIVES FOR BBC COMPUTERS £129.95



BBC
 MICRO COMPUTER



IN STOCK
6502 + Z80 SECOND
PROCESSOR · BITSTIK

WE ARE SPECIALISTS - WITH
OVER 400 ITEMS JUST FOR
BBC/ELECTRON ON
OUR PRICE LIST

PHONE
 BURGESS HILL
 (04446)
45636

Ask about our Maintenance Agreement

michael
 Business Systems Ltd
 195 LONDON ROAD BURGESS HILL SUSSEX

SKC [®] **PERFECTION ASSURED**
 FLOPPY DISK MEET ANSI, DIN, ECMA, IBM,
 JIS AND SHUGART SPECIFICATIONS.
 EVERY DISK IS CERTIFIED AND
 GUARANTEED TO BE 100%
 ERROR FREE.

5 1/4" diskettes Certified for Single OR Double Density media with hub ring PRICES EXC VAT		QUANTITY		PRICE PER
		1-10	10-40	DISC
48 tpi suitable for 40 track 96 tpi suitable for 80 track	MD1-S/S 48 tpi	1.61	1.17	1.12 1.05
	MD1-D/S 48 tpi	1.70	1.23	1.17 1.10
	MD2-D/S 48 tpi	2.00	1.44	1.37 1.29
	MD1-DD S/S 96 tpi	1.86	1.41	1.35 1.28
	MD2-DD D/S 96 tpi	2.33	1.76	1.68 1.60

VIDEO TAPES

VHS E-180 £41.00
 Beta L-750 £44.00

MD1-DD S/S 96 tpi
 PRICE PER
 BOX OF 10
 CARRIAGE CHGS.
 PLEASE SEND £2
 FOR BOX OF TEN—
 ANY QUANTITY
 ABOVE 10 ALLOW
 £5 FOR NEXT DAY
 DELIVERY.

Computer Cassettes

cat	playing time	per 100
C10	10 minutes	£23.00
C15	15 minutes	£24.00
C20	20 minutes	£25.00

High quality low noise cassette tapes. Short play, leaderless construction for use with computer cassette systems. Each tape in individual plastic library case with index card.

HOW TO ORDER For disks add 50p per box of ten for p&p. First class mail for small packets - next day delivery for heavier ones. For cassettes allow £5 carriage costs (min order is 100) for next day delivery. Post/carriage costs. add VAT.

P.V. TUBES

PLEASE ADD
 15% VAT
 TO ALL
 PRICES

 Dept. D
 104 ABBEY STREET, ACCRINGTON, LANCS BB5 1EE.
 Tel: (0254) 36521. (0254) 32611
 Telex: 635562 Griffin G for PV

MM

UNBELIEVABLE SAVINGS

**** COMPUTERS ****

		EX VAT
APRICOT	F1 - from	£675.00
APRICOT	Point 7 from	£2950.00
APRICOT	PORTABLE from	£1445.00
APRICOT	256K 315Kx2 MONITOR	£1395.00
APRICOT	256K 720Kx2 MONITOR	£1545.00
APRICOT	XI 256k 10MB MONITOR	£2195.00
CIFER	9000 Multi User 21MB	£5095.00
COMMODORE	8250 DISK DRIVE	£785.00
COMMODORE	8296	£695.00
COMMODORE	SX-64 PORTABLE	£675.00
COMMODORE	64	£156.51
COMMODORE	DISK 1541	£165.21
COMMODORE	IBEK PARALLEL INTERFACE	£59.50
COMMODORE	1530 C2N CASSETTE	£32.00
COMPAQ		£1795.00
KAYPRO	II	£945.00
KAYPRO	10MB	£1995.00
OLIVETTI	M20 160KB 2x320KB Drives	£1295.00
OLIVETTI	M24 128KB 2x360KB Drives	£1658.00
OLIVETTI	M24 128KB 10MB Hard Disk	£3315.00
SAGE	II & IV	POA
SANYO	MBC 555 128K 2x160K Drives	£795.00
SIRIUS	256K 10MB	£2850.00
SIRIUS	256K 2.4MB	£2095.00
SIRIUS	128K 1.2MB	£1545.00
SIRIUS	Memory Expansions from	£222.00
SIRIUS	Express Accelerator Boards	POA
PLUS 5	External Hard Disk Drives	POA

**** SOFTWARE ****

ALL MAJOR SOFTWARE PROGRAMS SUPPLIED AT LOW COST

WORDSTAR	£195.00
OPEN ACCESS	£360.00
LOTUS 123	£295.00
SYMPHONY	£490.00
MULTIMATE	£240.00
D BASE II	£280.00
DMS DELTA	£395.00
FRIDAY	£135.00
FRAMEWORK	£345.00

Not only do we offer top quality products at low prices. We also support and develop Software with the assistance of our long established software dept.

**** MATRIX PRINTERS ****

	EX VAT	
ANADEx	DP-6500 500cps	£2019.00
ANADEx	WP-6000	£1808.00
BROTHER	EP44	£199.00
BROTHER	HR5	£129.00
CANON	PW1080A 160cps (NLQ)	£279.00
CANON	PW1156A 160cps (NLQ)	£339.00
EPSON	RX 80T 100cps	£195.00
EPSON	RX 80F/T 100cps	£220.00
EPSON	FX 80 160cps	£324.00
EPSON	FX 100F/T 160cps	£430.00
EPSON	LQ 1500 200cps (NLQ)	£895.00
HONEYWELL	From	£375.00
MANNESMANN	MT80 80cps	£199.00
MANNESMANN	MT180 160cps (NLQ)	£590.00
NEC	PINWRITER P2(P)	£535.00
NEWBURY	DRE 8850 300ipm	£2095.00
NEWBURY	DRE 8925 240cps	£1385.00
OKI	82A 120cps	£255.00
OKI	84A 200cps	£630.00
OKI	OKI 92P 160cps	£379.00
OKI	OKI 2410P 350cps	£1535.00
SEIKOSHA	GP100A	£165.00
SHINWA	CP80 Model II FT	£175.00
STAR	DELTA 10 160cps	£319.00
STAR	DELTA 15 160cps	£435.00
STAR	GEMINI 10X 120cps	£189.00
STAR	GEMINI 15X 120cps	£285.00
STAR	RADIX 10 200cps (NLQ)	£449.00
STAR	RADIX 15 200cps (NLQ)	£549.00
TEC	1550 120cps	£465.00
TOSHIBA	TH2100H 192cps	£1275.00
TREND	930 200cps NLQ 80cps	£1350.00

MAYFAIR MICROS

BLenheim HOUSE, PODMORE ROAD,
 LONDON SW18 1AJ

TEL: 01-870 3255

We accept official orders from UK Government and Educational Establishments. Mail Order and Export Enquiries welcome. Callers by appointment.

**** DAISYWHEEL ****

**** PRINTERS ****

	EX VAT	
BROTHER	HR1	£445.00
BROTHER	HR15	£329.00
BROTHER	HR15 Keyboard	£135.00
BROTHER	HR15 Sheetfeeder	£185.00
BROTHER	HR15 Tractor Feed	£62.00
BROTHER	HR25	£549.00
DAISYSTEP	2000 20cps	£240.00
DIABLO	630 API	£1315.00
DIABLO	Sheet Feeder	£490.00
JUKI	6100 18cps	£325.00
NEC	2010 Serial 20cps	£545.00
NEC	2030 Parallel 20cps	£545.00
NEC	3510 Serial 35cps	£1049.00
NEC	3530 Parallel 35cps	£1049.00
NEC	7710 Serial 55cps	£1440.00
NEC	7730 Parallel 55cps	£1440.00
QUME	11/40 RO	£1185.00
QUME	11/55 RO	£1370.00
QUME	9/45 RO	£1550.00
QUME	9/55 RO	£1900.00
RICOH	RP1300S	£895.00
RICOH	RP1600S	£1190.00
RICOH	RP1600S FLOWWRITER 8k	£1249.00
RICOH	RP1600S FLOWWRITER 8k	£1249.00
RICOH	IBM PC	£1299.00
RICOH	RP1600S Sheet Feeder	£459.00
RICOH	RP1600S Tractor	£138.00
RICOH	SMITH	
CORONA	TP1 12cps	£195.00
TEC	STARWRITER F1040 40cps	£895.00
TEC	STARWRITER F1055 55cps	£1235.00
TEC	Sheetfeeder	£459.00
TEC	Tractor	£138.00

**** VDU's & TERMINALS ****

CIFER	T4	£760.00
HAZELTINE	ESPRIT Fixed Keyboard	£395.00
QUME	QVT 103 (VT100 VT131)	£695.00
TELEVIDEO	910	£489.00

**** PLOTTERS ****

MANNESMANN	PIXY PLOTTER	£495.00
GOULD	PLOTTER	POA

Paged Ram listing

From Page 78

```

10 REM *****
20 REM *
30 REM * PAGED RAM *
40 REM * by G.A.PHILIP *
50 REM * (C) MICRO USER *
60 REM *****
70 osrdch=&FFE0:oswrch=&FFEE
80 osnewl=&FFE7:osbyte=&FFF4
90 FOR I%=0 TO 3 STEP 3
100 P%=&B000
110 [OPTIX
120 .ram \for explanations see arti
cle
130 JMP langentry
140 JMP serviceentry
150 EQU B &82
160 EQU B &11
170 EQU B &01
180 .title
190 EQU S "RAM"
200 EQU B &20
210 EQU S "1.00"
220 EQU B &00
230 EQU S "(C)1984 G.A.PHILIP"
240 EQU B &00
250 .serviceentry
260 PHP
270 CMP #4
280 BEQ unrecomm
290 CMP #9
300 BEQ help
310 PLP
320 RTS
330 .help
340 PHA
350 TXA
360 PHA
370 TYA
380 PHA
390 JSR osnewl
400 LDX #0
410 .titleloop
420 LDA title,X
430 JSR oswrch
440 INX
450 CPX #8
460 BNE titleloop
470 JSR osnewl
480 .out
490 PLA
500 TAY
510 PLA
520 TAX
530 PLA
540 PLP
550 RTS
560 .unrecomm
570 PHA
580 TXA
590 PHA
600 TYA
610 PHA
620 LDX #0
630 .unrecogloop
640 LDA (&F2),Y
650 CMP title,X
660 BNE notthisrom
670 INY
680 INX
690 CPX #3
700 BNE unrecogloop
710 LDA (&F2),Y
720 CMP #ASC("L")
730 BEQ languageentry
740 JMP demonstration
750 .notthisrom
760 JMP out
770 .languageentry
780 LDX &F4
790 LDA #&BE
800 JSR osbyte
810 .exit
820 PLA
830 PLA
840 PLA
850 PLA
860 LDA #0
870 RTS
880 .langentry
890 CLI \enable interrupts
900 .demonstration
910 .hexandasciidump
920 LDA #&B0 \start from &8000
930 STA &F3
940 LDA #0
950 STA &F2
960 .newblock
970 LDX #0 \ x holds no of lines
980 .newline
990 JSR osnewl \blank line for neat
ness
1000 LDA &F3 \print address
1010 JSR hextoascii
1020 LDA &F2
1030 JSR hextoascii
1040 JSR space \space for neatness
1050 LDY #0
1060 .hexcontents \print ?&B000,Y
1070 LDA (&F2),Y \in hex
1080 JSR hextoascii
1090 JSR space
1100 INY
1110 CPY #8 \in blocks of 8
1120 BNE hexcontents
1130 JSR space
1140 LDY #0
1150 .asciicontents \and then in ASC
II
1160 LDA (&F2),Y
1170 CMP #32
1180 BCC printadot \A<=31 not contro
l
1190 CMP #127 \or user characte
rs
1200 BCS printadot \A>=127
1210 JMP print
1220 .printadot \print a dot instead
1230 LDA #ASC(".")
1240 .print
1250 JSR oswrch
1260 INY
1270 CPY #8 \in blocks of 8
1280 BNE asciicontents
1290 CLC
1300 LDA &F2 \increase address by 8
1310 ADC #8
1320 STA &F2
1330 LDA &F3
1340 ADC #0
1350 STA &F3
1360 INX
1370 CPX #8 \8 lines yet?
1380 BNE newline
1390 JSR osnewl \blank line for neat
ness
1400 JSR osrdch \wait for instructio
ns
1410 CMP #32 \space bar?
1420 BEQ newblock \yes - print block
1430 JSR osnewl \no - print blank
line
1440 JMP exit \then exit
1450 .hextoascii \split a byte into
two nibbles
1460 PHA
1470 LSR A
1480 LSR A
1490 LSR A
1500 LSR A
1510 JSR printascii \ and print each
as
1520 PLA \ an ASCII chara
cter
1530 AND #&0F \ 0 to F
1540 JSR printascii
1550 RTS
1560 .space
1570 LDA #32
1580 JSR oswrch
1590 RTS
1600 .printascii \print a hex number
1610 CLC \ in ASCII ie 0=&48
1620 ADC #48
1630 CMP #58 \for 0-9
1640 BCC over
1650 ADC #6 \for A-F
1660 .over
1670 JSR oswrch
1680 RTS
1690 ]
1700 NEXT

```

This listing is included in this month's cassette tape offer. See order form on Page 217.

Teleph
Order
574 5

PR
FREE
SHEP
PRIN

DOT

EPSON
FX80

EPSON
EPSON
FX80 is e
character
quick for
addressab
character
compatib
RS-232C
FX80 is p
single sho

SHIN
CP 80

80 colum
and adju
feed, bi-c
seeking E
block gra
and emp
and hori

BRO

13 CPS.
up to 16
shadow
underlin
Keyboa
Sheet Fe
Tractor

Tu
Li
17 RE
TEL: C

Telephone
Orders
574 5271

The Twillstar Reliability. It's what makes us The Leading Computer Shop!

* TAKE ADVANTAGE OF OUR 24 HOUR TELEPHONE ORDERING SERVICE *

PRINTERS

FREE INTERFACE CABLE & 500 SHEETS OF PAPER WITH ALL PRINTERS

DOT MATRIX £389

EPSON
FX80

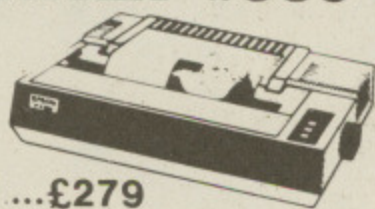

EPSON R80 ...£279

EPSON FX100.....£489

FX80 is even faster. An astonishing 160 characters per second, proportional spacing, quick forms tear-off, superscripts, subscripts, dot addressable graphics and down loadable characters set. Standard Centronics parallel compatible interface with optional RS-232C/current loop and IEEE interfaces. The FX80 is pin fed and friction fed and can feed single sheets (optional tractor feed).

SHINWA CP 80

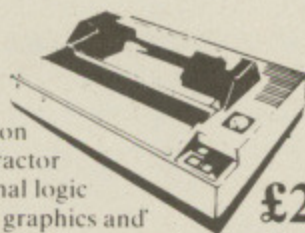

£230

80 column, friction and adjustable tractor feed, bi-directional logic seeking HI-RES graphics and block graphics sub and super scripts, condensed and emphasised print, and underlining vertical and horizontal tabs, self test, italic print, etc.

BROTHER HR15

£395

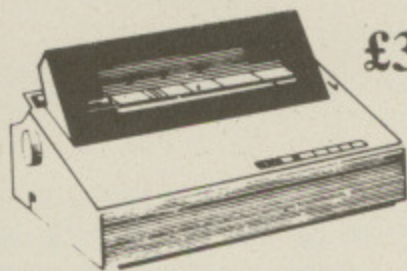

13 CPS, 10, 12, 15 CPI and proportional spacing up to 165 characters per line, colour printing, shadow printing, super/sub script, auto underlining, text reprinting, 3K Buffer Standard.
Keyboard£160
Sheet Feeder£228
Tractor Unit£109

MONITORS

ALL MONITORS COME WITH FREE CONNECTING CABLES

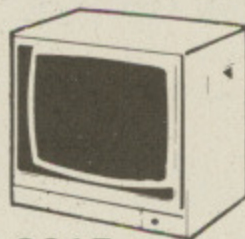

£215

NOVEX 14" MONITOR

Low-cost model for personal computers. 14" Screen colour display, R.G.B. and composite inputs.

Switch to allow monitor to be used as green screen monitor. Switch mode auto-regulated power supply. Professionally-styled Metal-Cabinet in BBC Micro-colours.

TV/MONITOR

£249

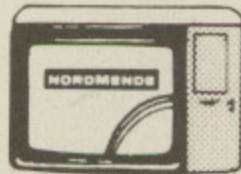

14" TV/MONITOR

This TV Monitor is not a modified television as many TV Monitors are, but a 14" TV/Monitor which has been designed to perform both functions. It has RGB and Composites video and sound. An RGB cable for a BBC is supplied as standard. With Remote Control.

MICROVITEC 14" Colour Monitors

Microvitec 1431 14 Std. Res.....	£199.00
Med. Res.....	£345.00
Hi-Res.....	£442.00

DISK DRIVES

TEAC DISK DRIVES

INCLUDES FREE CABLES, FORMATTING DISK & MANUALS

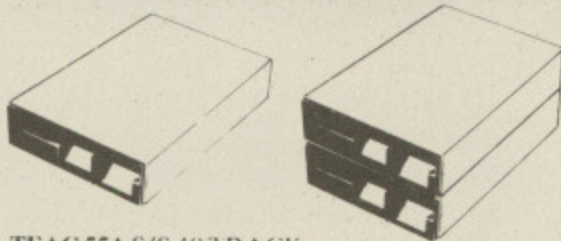

TEAC 55A S/S 40 TRACK

100K Single.....	£140.00
200K Dual.....	£280.00

TEAC 55E S/S 80 TRACK

200K Single.....	£190.00
400 Dual.....	£380.00

TEAC 55F D/S 80 TRACK

400K Single.....	£220.00
800K Dual.....	£440.00
Power Supply Unit (Optional).....	£29.00
40/80 Switch.....	£ 8.00

ACORN SPEECH SYSTEM

The system contains a Speech Processor and a special chip called a Phrase Read Only Memory (PHROM).

The Speech Processor contains a digital filter which is rather like a computer version of the human vocal tract. It relies on being fed to a large number of parameters to produce the necessary sounds for making speech.

£55.00

DAISYWHEELS

£379

JUKI 6100

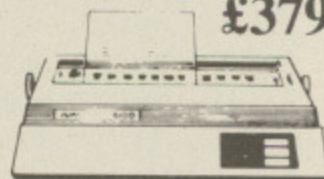

20 CPS max

(13 CPS

Shannon text)

10, 12, 16 CPI

and proportional spacing up to 220 characters per line, diablo protocol. Bold, shadow printing and underlining.

WORD PROCESSING PACKAGE

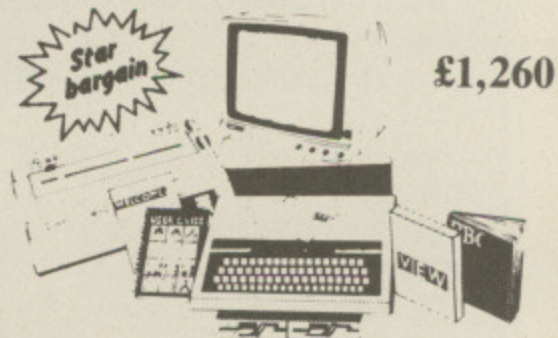

£1,260

BBC Model B plus Disc Interface fitted view, VDU Green Monitor, Daisywheel Printer, 200K Dual Disk Drives and manual and formatting disk. Only £1,260 (inc. all cables)

HOW TO ORDER

You may purchase any of the items listed by cheque made payable to: Twillstar Computers Ltd. Barclaycard or Access. All you have to do is fill in your requirements on a separate sheet of paper, post to us and we will despatch within 24 hours, subject to availability. All prices inclusive of 15% VAT. ADD £2.50 P&P for orders below £150. OVER, ADD £8 P&P. CREDIT CARD HOLDERS MAY ORDER BY TELEPHONE. GIVE CARD NUMBER, NAME, ADDRESS AND ITEMS REQUIRED. PLEASE NOTE VAT IS NOT CHARGED ON EXPORT ORDERS. EXPORT CUSTOMERS, PLEASE RING FOR DETAILS OF P&P.

TCL

Twillstar Computers Limited

17 REGINA ROAD · SOUTHALL · MIDDLESEX
TEL: (01) 574 5271 · TELEX NO. 25247 TIL

open 6
days a week
10am - 8pm

Wampus listing

From Page 85

```

100 REM *****
110 REM *
120 REM * HUNT THE WAMPUS *
130 REM * (C) Micro User *
140 REM * By *
150 REM * A.DENHAM 1984 *
160 REM *
170 REM *****
180 MODE7
190 PROCIN.
200 MODE4
210 ENVELOPE1,3,-1,-2,-3,255,255,15
0,100,-3,0,-3,126,80
220 DIM M(60)
230 PROCMAP
240 REM MAIN PROGRAM
250 AR=3:REM number of arrows
260 CL$="1A":REM start position
270 End=0
280 REM Locate various hazards
290 L$=CHR$(65+RND(100)MOD3)
300 WA$=STR$(RND(20))+L$
310 P1$=STR$(RND(20))+ "C"
320 P2$=STR$(RND(20))+ "C"
330 B1$=STR$(RND(20))+CHR$(65+RND(1
00)MOD3)
340 B2$=STR$(RND(20))+CHR$(65+RND(1
00)MOD3)
350 S1$=STR$(RND(20))+CHR$(65+RND(1
00)MOD3)
360 S2$=STR$(RND(20))+CHR$(65+RND(1
00)MOD3)
370 REM Hazards located:check for f
orbidden locations
380 IF WA$=B1$ OR WA$=B2$ OR WA$=S1
$ OR WA$=S2$ OR WA$=P1$ OR WA$=P2$ OR
WA$="1A" OR WA$="2A" OR WA$="5A" OR
WA$="11A" OR WA$="1B" THEN GOTO290
390 IF B1$=B2$ OR B1$=S1$ OR B1$=S2
$ OR B1$=P1$ OR B1$=P2$ OR B1$="1A" O
R B1$="2A" OR B1$="5A" OR B1$="11A" O
R B1$="1B" THEN GOTO290
400 IF B2$=S1$ OR B2$=S2$ OR B2$=P1
$ OR B2$=P2$ OR B2$="1A" OR B2$="2A"
OR B2$="5A" OR B2$="11A" OR B2$="1B"
THEN GOTO290
410 IF S1$=S2$ OR S1$=P1$ OR S1$=P2
$ OR S1$="1A" OR S1$="2A" OR S1$="5A"
OR S1$="11A" OR S1$="1B" THEN GOTO29
0
420 IF S2$=P1$ OR S2$=P2$ OR S2$="1
A" OR S2$="2A" OR S2$="5A" OR S2$="11
A" OR S2$="1B" THEN GOTO290
430 REM Hazards placed and checked
440 REM Start of main loop
450 LV$=RIGHT$(CL$,1):REM level
460 PROCLOC
470 RESTORE
480 LE=LEN(CL$):J$=LEFT$(CL$,LE-1):
REM For catching mistakes
490 REPEAT
500 READ N$,O$,P$,Q$,R$,S$
510 UNTIL N$=CL$:REM locates presen
t position
520 IF CL$=P1$ OR CL$=P2$ THEN SOUND
DI,1,200,100:PRINT"AAAAAAAAARRRGH!":P
RINT"YOU'VE FALLEN DOWN A BOTTOMLESS
PIT.":PROCDEAD:GOTO 240
530 IF CL$=B1$ OR CL$=B2$ THEN PROC
BATS:GOTO440
540 IF CL$=WA$ THEN PRINT"THE WAMPU
S IS IN THIS CAVE!":PRINT:PRINT"IT HA
S EATEN YOU.":PRINT:PRINT"THAT WAS RA
THER POOR HUNTING!":PROCDEAD:GOTO240
550 IF CL$=S1$ OR CL$=S2$ THEN PROC
SPID
560 PROCWARNINGS
570 *FX15,1
580 IF H=0 THEN PRINT:PRINT"NO OBVI
OUS DANGER!"
590 PROCWAIT
600 PROCHUNT
610 IF B$="Y" THEN PROCshoot:IF End
=1 GOTO240
620 PRINTTAB(2)"Cave ";CL$;" connec
ts to caves ":PRINT:PRINT SPC(11)O$;"
, ";P$"; ", ";Q$
630 IF LV$="A" THEN 660
640 IF LV$="B" THEN 670
650 IF LV$="C" THEN 680
660 PRINTTAB(2,4)"It also has a sha
ft going down to ";R$:GOTO690
670 PRINTTAB(2,4)"It also has shaft
s up & down to ":PRINT:PRINTSPC(13)R$
;" & ";S$:GOTO690
680 PRINTTAB(2,4)"It also has a sha
ft going up to ";R$:GOTO690
690 PRINTTAB(1,8)"Where do you want
to go?"
700 *FX15,1
710 PRINT:INPUT SPC(10) K$
720 U$=RIGHT$(K$,1):IF U$(">")"A" AND
U$(">")"B" AND U$(">")"C" THEN PRINT"NOT CO
MPLTE. PLEASE RE-TYPE WITH LETTER":G
OTO 710
730 IF K$=CL$ THEN PRINT"You're alr
eady there,silly.":GOTO 710
740 IF K$(">")O$ AND K$(">")P$ AND K$(">")Q$
AND K$(">")R$ AND K$(">")S$ THEN PRINT"YOU
CAN'T GO STRAIGHT THERE!":PRINT"LOOK
AT THE MAP":FOR Co=0 TO 8000:NEXT:CL
S:GOTO620
750 CL$=K$
760 CLS:GOTO 440
770 REM End of main loop
780 DEFPROCWARNINGS
790 H=0
800 IF O$=P1$ OR P$=P1$ OR Q$=P1$ O
R R$=P1$ OR S$=P1$ OR O$=P2$ OR P$=P2
$ OR Q$=P2$ OR R$=P2$ OR S$=P2$ THEN
H=H+1:PRINTTAB(2,7)"YOU CAN FEEL A BI
T OF A BREEZE!":PRINT"THIS MUST MEAN
THERE IS A PIT NEARBY!"
810 IF O$=B1$ OR P$=B1$ OR Q$=B1$ O
R R$=B1$ OR S$=B1$ OR O$=B2$ OR P$=B2
$ OR Q$=B2$ OR R$=B2$ OR S$=B2$ THEN
H=H+1:PRINTTAB(2,5)"TWITTER,TWITTER!Y
OU CAN HEAR BATS!"
820 RESTORE
830 J=0:W=0
840 REPEAT
850 READ A$,B$,C$,D$,E$,F$
860 UNTIL A$=N$ OR A$=O$ OR A$=P$ O
R A$=Q$ OR A$=R$ OR A$=S$
870 PROCWAMPUS:J=J+1:IF LV$="A" AND
J=5 OR LV$="C" AND J=5 OR LV$="B"AND
J=6 THEN ENDPROC
880 IF W=1 THEN ENDPROC
890 GOTO840
900 DEFPROCWAMPUS
910 IF A$=WA$ OR B$=WA$ OR C$=WA$ O
R D$=WA$ OR E$=WA$ OR F$=WA$ THEN W=1
:GOTO920
920 IF W=1 THEN PRINTTAB(1,10)"GOSH
!WHAT A PONG! YOU CAN SMELL WAMPUS!":
H=H+1
930 ENDPROC
940 DEFPROCshoot
950 VDU28,0,13,10,0:REM window
960 PRINT:PRINT"Do you want":PRINT"
to try":PRINT:PRINT" to shoot":PR
INT:PRINT"the WAMPUS?":PRINT" Y/N"
:PRINT:PRINT"?????????"
970 B$=GET$:CLS:VDU28,0,31,39,19
980 ENDPROC
990 DEFPROCSPID
1000 PRINT:PRINT"THE SPIDERS HAVE 60
T YOU!":FOR T=0 TO 3000:NEXT:PRINT:PR
INT"YOU ARE TANGLED UP IN THEIR WEBS!
":FOR T=0 TO 6000:NEXT:PRINT:PRINT"YO
U CAN HEAR THE WAMPUS MOVING ABOUT!!!
":FOR T=0 TO 6000:NEXT
1010 FOR M=1 TO 2:L$=CHR$(65+INT(RND
(1)+0.5)):WA$=STR$(RND(20))+L$:IF WA$
=CL$ THEN PRINT"THE WAMPUS HAS COME I
NTO THIS CAVE!":PRINT"IT IS EATING YO
U!":PRINT"YOU ARE DEAD.":PROCDEAD:W=2
ELSE NEXT
1020 IF End=1 THEN ENDPROC ELSE PRIN
T:PRINT"THAT WAS LUCKY! IT HAS NOT FO
UND YOU.":PRINT:PRINT"YOU CAN GET FRE

```



Tw
INGEN
This is the
ingenious
Ideal for u
envisage
Compatib
on either

DESIGN
This 3" D
casing, w
which pro
easy inse
tough co
The size

FEATU
This 3" D
100K ear
cables, f
use, and
BBC Mic
TCL (TV
LABOU

DISKE
You may
cassette
protecte
closed b
transfer
on-line s

T
Tw
Lin

TCL-PANASONIC

3" Disk Drive - The Choice . . .

Special!

ONLY
£99 + VAT



Twillstar Computers Offer

INGENUITY, DURABILITY, COMPATABILITY . . .

This is the Twillstar (TCL) Panasonic 3" Disk Drive which features the ingenious dual-sided cartridge protected disk, 200K (100K per side). Ideal for use in education and other environments where rough use is envisaged.

Compatible with all disk interfaces, comprehensive manual and utilities on either disk or EPROM.

DESIGN, COLOUR, SIZE . . .

This 3" Disk Drive is totally housed in a high stability aluminium two piece casing, with a light plastic face, and a unique automatic steel shutter which protects the disk surface. A highly sensitive injection key allows easy insertion and extraction of your diskette. The case is finished in a tough coating of beige to match the colour of your BBC.

The size is a compact 160mm length x 90mm wide x 55mm deep.

FEATURES, CAPACITY, USAGE . . .

This 3" Disk Drive uses 3" diskettes which are handled like a cassette, 100K each side of the diskette, giving you 200K. It can be purchased with cables, formatting disk and comprehensive manual. Ready to plug in and use, and remember, it is compatible with all known disk interfaces for the BBC Micro - and no extra power supply is required. The PANASONIC TCL (TWILLSTAR) 3" Disk Drive carries a 12 MONTH PARTS AND LABOUR GUARANTEE!

DISKETTES, SPECIFICATIONS, ACCESS . . .

You may use any 3" Diskettes, Maxell, Panasonic, Hitachi etc; these are cassette like cartridges encaged in rigid plastic with the disk surfaces protected by a stainless steel shutter which is automatically opened and closed by the Disk Drive. Track to track access time is three ms. Data transfer rate 125 kbs-1. Dual double sided Disk Drives give 1 megabyte of on-line storage.

YOUR SPECIAL PRICES!

3" TCL/PANASONIC DISK DRIVE
Offer Price £99 + VAT = £113.85
(Includes Manual)

CABLES AND FORMATING DISK
Offer Price £19 + VAT = £21.85

3" PANASONIC DISKETTES
Special Offer of £4.50 each

HOW TO ORDER

To take advantage of this special offer all you have to do is fill in the coupon below with your name and address, enclosing your cheque/P.O made payable to Twillstar Computers Ltd; if you are a Barclaycard or Access card holder, please use the coupon and post to:
TWILLSTAR COMPUTERS LTD, 17 REGINA ROAD, SOUTHALL, MIDDLESEX

**Post to: TWILLSTAR COMPUTERS LTD,
17 REGINA ROAD, SOUTHALL, MIDDLESEX.**

Please send me (No.) _____ 3" TCL Panasonic Disk Drives, at £113.85 inclusive of VAT, plus £3.50 post, packing and insurance.

Also send me (No.) _____ Cable(s) for (state your micro) _____ and Formating Disk and Manual at £23.00 each inclusive of VAT.

I would like to take advantage of 3" Diskettes by PANASONIC please send me (No.) _____ at £4.50 each inclusive of VAT.

I enclose my cheque/P.O. for £ _____

I prefer to use my **ACCESS/BARCLAYCARD**
(delete whichever not applicable)

Card No. _____

Signature _____

Name _____

Address _____

Credit cards valid if signed by card holder. Address above must be the same as the card holder.



Twillstar Computers Limited

17 REGINA ROAD, SOUTHALL, MIDDLESEX UB2 5PL TEL: (01) 574 5271



EVANSOFT SOFTWARE SUPER-FILE

The disc based filing system/database for everyone. Many uses for home or small business. Before buying a data base check our specifications.

- ★ Nearly 100k storage on single disc.
- ★ Allows creation of your own dedicated filing system easily.
- ★ Locate a single file by any category.
- ★ Allows alteration and deletion of any file.
- ★ Compatible with most printers.
- ★ Supplied on 40 track disc complete with instructions.
- ★ Can be used to replace any card, register or index filing system.
- ★ Applications include Recipe Cards, Telephone Directory, Disc Catalogue, Diary and many many more.
- ★ Easy for anyone to use no knowledge of programming necessary. For BBC model 'B' with single or dual disc drive. BASIC 1 or 2.

£15.95 inc.

Cheque or P.O. to:

**EVANSOFT SOFTWARE, 92, Goetre Fawr Road,
Killay, Swansea SA2 7QU.
DEALER ENQUIRIES WELCOME**

O LEVEL MATHS/PHYSICS

For 32K BBC Micros & Electrons
Multiple-Choice Revision Programs

- Large database of questions – random selection for each test.
 - End of test score, time-report, answer-check.
 - Cut-off option, on time-report, answer-check
 - Cut-off option, on time-up you're marked on the number of questions completed
- £10.95 per cassette (inc. p&p): Both for £20 S.A.E. for further details.**

Helowell
Software

157 St. Peters Road,
Reading RG6 1PG

£6

inc. P&P

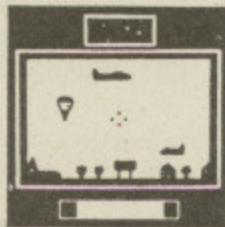

SCREEN DIAGRAM

32k BBC MICRO ANTI-AIRCRAFT GUN SIMULATOR

NOW WITH

!!FREEZE FRAME OPTION!!

- 100% Machine Code
- Hi-Speed Graphics
- Three winning score levels
- Sound on/off option during play
- Long range radar screen
- Scrolling, scenery
- Keys or joystick
- Freeze frame
- Re-set option

All P.O. orders sent by return, cheques 7 days.

CHALLENGING—FRUSTRATING—FUN

7 OBRIDGE ROAD, TAUNTON
SOMERSET TA2 7PX

£6

inc. P&P



software
division
COMPUTER SERVICES

ALL IN STOCK

S.P. ELECTRONICS

SPECIALISTS
BBC

Acorn Electron	£199.00
BBC Model B 1.2 O.S.	£399.00
CP80 Printer (inc. cable) ..	£229.00
Disc Operating System	£96.00
Disc Drives	from £175.00
Disc Operating System D-Density	£104.00
G3 WHO RTTY PROGRAM (TAPE)	£7.50
G3 WHO RTTY PROGRAM (EPROM VERSION)	£20.00
Circuit board for RTTY decoder Mk.3 (inc. instructions)	£7.00
Star 10X Printer (inc. cable)	£275.00
CANNON Dot Matrix 160cps NLQ	£350.00
Joysticks (pair) self centering + analogue	from £17.95
Printer Cable (Centronics)	£12.90
Speech Synthesis	£55.00
Disc Doctor	£33.00
WORDWISE Word Processor	£39.00
Slow Scan TV Circuit Board + Program (inc. instructions)	£17.50

Wide selection of software, books, leads, plugs, etc.

SAE for full list. All available Mail Order

48 Linby Road, Hucknall,
Notts. NG15 7TS.
Tel: 0602 640377

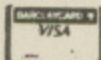

(all prices include VAT)

All prices apply
while stocks last.

Carriage
extra

DAISY STEP 2000 Daisy Wheel Printer

Twillstar Computers Offer £259 INCLUSIVE

Telephone
Orders
574 5271



*FREE CABLE
*FREE PAPER

... At the special price of £259 inclusive of VAT and Post, Packing and Insurance, this is indeed a unique opportunity to own an amazing flexible Daisy Wheel Printer!

Just look at the features!

1. 18 CPS
2. Bidirectional
3. Logic seeking
4. Proportional tracing
5. Wordstar compatible
6. 13" platen - 12" print line
7. Auto underscore
8. Bold and shadow printing
9. Sub & superscripts
10. QUME compatible ribbons
11. QUME compatible daisywheels
12. 4 level impression control
13. Prints original + 4 copies
14. Low noise

This extremely attractive printer comes complete with free printer cable and 500 sheets of test run paper – just to make sure you get everything running smoothly!

TCL

HOW TO ORDER

To purchase this Daisy Step 2000 Daisy Wheel Printer, simply write your name and address on a piece of paper, and post to us enclosing your cheque or P.O. made payable to Twillstar Computers Ltd. If you are an Access/Barclaycard holder, simply use the telephone to place your order.

Twillstar Computers Limited

17 Regina Road, Southall, MIDDLESEX, UB2 5PL. TEL: (01) 574 5271

Wampus listing

From Page 172

t when you"

1760 PRINT"are in the cave next to i
t.":PROCHOLD

1770 PRINT:PRINT:PRINT"You will not
see the spiders until after":PRINT"th
ey catch you.":PRINT:PRINT"Just hope
that you can get away before":PRINT:P
RINT"the WAMPUS visits your cave!":PR
OCHOLD

1780 PRINTTAB(2,3)"To help you find
the WAMPUS":PRINT:PRINTSPC(4)"(before
it finds you)":PRINT:PRINT"you can s
mell it from two caves away."

1790 PRINT:PRINT:PRINT:PRINT"When yo
u think you know where the WAMPUS":PR
INT"is you can shoot it with magic ar
rows.":PRINT:PRINT:PRINT"You will fin
d out about those later."

1800 PRINT:PRINT:PRINT SPC(7)"GOOD L
UCK":PRINTTAB(18)"(you might need it!
)"

1810 PROCHOLD

1820 ENDPROC

1830 DEFPROCWIN

1840 FOR Z=1 TO 2

1850 SOUND 1,-15,48,8

1860 SOUND 1,0,0,1

1870 SOUND 1,-15,48,8

1880 SOUND 1,0,0,1

1890 SOUND 1,-15,48,16

1900 SOUND 1,0,0,1

1910 NEXT

1920 FOR Z=1 TO 2

1930 SOUND 1,-15,64,8

1940 SOUND 1,0,0,1

1950 NEXT

1960 SOUND 1,-15,64,16

1970 SOUND 1,0,0,1

1980 SOUND 1,-15,56,4

1990 SOUND 1,0,0,1

2000 SOUND 1,-15,48,16

2010 FOR J=1 TO 5

2020 FOR K=0 TO 7

2030 VDU19,1,K;0;

2040 FOR L=1 TO 250:NEXT

2050 NEXT:NEXT

2060 VDU19,1,7;0;

2070 PRINT"YOU'VE KILLED IT":PRINT:P
RINT"WELL DONE.":End=1

2080 ENDPROC

2090 DEFPROCCHOLD:PRINTTAB(8,23)"Pres
s SPACE BAR to go on":K=GET:CLS:ENDPR
OC

2100 DEFPROCWAIT:PRINTTAB(8,11)"Pres
s SPACE BAR to go on":G\$=GET\$:CLS:END
PROC

2110 DEFPROCMAP

2120 VDU23,240,255,255,255,255,2
55,255,255

2130 VDU 29,810;772;

2140 FOR Z=1 TO 360:READ A\$:NEXT

2150 VDU5

2160 FOR C=1 TO 4

2170 J=0:V=0

2180 FOR U=1 TO 4

2190 J=J+1

2200 IF U=1 THEN S=290

2210 IF U=2 THEN S=150

2220 IF U=3 THEN S=210

2230 IF U=4 THEN S=80

2240 FOR AN=0 TO 359 STEP 72

2250 X=1.5*S*SIN(RAD(AN-36*(J MOD 2)
)

2260 Y=S*COS(RAD(AN-36*(J MOD 2)))

2270 V=V+1

2280 ON C GOSUB 2330,2340,2400,2420

2290 NEXT:NEXT:NEXT

2300 VDU4

2310 GOTO 2430

2320 REM Subroutines for graphics

2330 M(3*V-2)=INT(V):M(3*V-1)=INT(X)
:M(3*V)=INT(Y):RETURN

2340 READ P,Q,R,S

2350 A=M(3*P-1)+16:B=M(3*P)-16

2360 MOVE A,B:DRAW(M(3*Q-1)+16),(M(3
*Q)-16)

2370 MOVE A,B:DRAW(M(3*R-1)+16),(M(3
*R)-16)

2380 MOVE A,B:DRAW(M(3*S-1)+16,M(3*S
) -16

2390 RETURN

2400 MOVE X,Y

2410 PRINTCHR\$ 240;CHR\$ 240:RETURN

2420 GCOLOR,0:MOVE X,Y:PRINT;V:RETURN

2430 ENDPROC

2440 DEFPROCRRUN

2450 PRINT:PRINT"Do you want to have
another game? Y/N"

2460 *FX15,1

2470 G\$=GET\$:IF G\$="Y" THEN PRINT"Ok
ay, everything is being moved.....":G
OTO2490

2480 IF G\$="N" THEN PRINT"D.K.":PRIN
TSPC(10)"GOODBYE":END:ELSE GOTO2450

2490 FOR Z=0 TO 6000:NEXT

2500 FOR Z= 1 TO 5

2510 VDU19,1,0;0;:FOR M=0 TO 250:NEX
T

2520 VDU19,1,1;0;:FOR M=0 TO 250:NEX
T

2530 NEXT

2540 CLS:PRINT"OKAY, HERE WE GO":FOR
Z=0 TO 4000:NEXT:VDU19,1,7;0;:CLS

2550 ENDPROC

2560 DATA "1A","2A","5A","11A","1B",
"0"

2570 DATA "2A","1A","12A","3A","2B",
"0"

2580 DATA "3A","2A","13A","4A","3B",
"0"

2590 DATA "4A","3A","14A","5A","4B",
"0"

2600 DATA "5A","4A","15A","1A","5B",
"0"

2610 DATA "6A","12A","11A","16A","6B
", "0"

2620 DATA "7A","12A","13A","17A","7B
", "0"

2630 DATA "8A","13A","14A","18A","8B
", "0"

2640 DATA "9A","14A","19A","15A","9B
", "0"

2650 DATA "10A","20A","11A","15A","1
0B", "0"

2660 DATA "11A","10A","1A","6A","11B
", "0"

2670 DATA "12A","2A","6A","7A","12B
", "0"

2680 DATA "13A","3A","7A","8A","13B
", "0"

2690 DATA "14A","8A","9A","4A","14B
", "0"

2700 DATA "15A","9A","5A","10A","15B
", "0"

2710 DATA "16A","6A","17A","20A","16
B", "0"

2720 DATA "17A","7A","16A","18A","17
B", "0"

2730 DATA "18A","17A","8A","19A","18
B", "0"

2740 DATA "19A","18A","9A","20A","19
B", "0"

2750 DATA "20A","19A","10A","16A","2
0B", "0"

2760 DATA "1B","2B","5B","11B","1A",
"1C"

2770 DATA "2B","1B","12B","3B","2A",
"2C"

2780 DATA "3B","2B","13B","4B","3A",
"3C"

2790 DATA "4B","3B","14B","5B","4A",
"4C"

2800 DATA "5B","4B","15B","1B","5A",
"5C"

2810 DATA "6B","12B","11B","16B","6A
", "6C"

2820 DATA "7B","12B","13B","17B","7A
", "7C"

2830 DATA "8B","13B","14B","18B","8A
", "8C"

2840 DATA "9B","14B","19B","15B","9A
", "9C"

2850 DATA "10B","20B","11B","15B","1
0B", "0"

star *ATTRACTIONS*

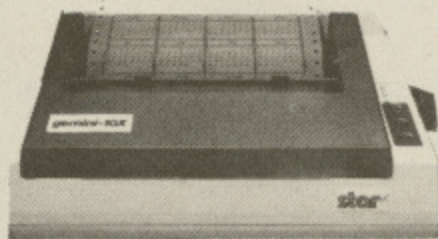

GEMINI 10X



12mHZ Video Bandwidth
RGB and Composite Video

£169.95 + VAT
=£195.44

Also available TV/Monitor
version

@**£195.95 + VAT = £225.34.** 14 INCH COLOUR MONITOR

£189.95

+VAT=£218.44

120CPS · Bi-directional
· Logic seeking · Friction
tractor and roll holder
standard · Downloadable
characters · Ultra high
resolution · 80 cols.
· IBM PC version now
available.



LOOK!

NEW LOWER PRICES ON EPSON STAR & BROTHER

DAISYWHEEL PRINTERS

BROTHER HR 15	CALL FOR BEST PRICE
EPSON DX 100	£369.95 + VAT=£425.44
JUKI 6100	£325 + VAT=£373.75
DAISYSTEP 2000	£225 + VAT=£258.75

DOT MATRIX PRINTERS

EPSON RX 80	£198.95 + VAT=£228.79
EPSON RX 80F/T	£228.95 + VAT=£263.29
EPSON RX 100	£384.95 + VAT=£442.69
EPSON FX 80	£319.95 + VAT=£367.94
EPSON FX 100	£498.95 + VAT=£573.79
STAR GEMINI-10X	£189.95 + VAT=£218.44
STAR DELTA 10	£319.95 + VAT=£367.94
STAR RADIX 10	£498.95 + VAT=£573.79

THERMAL MATRIX PRINTERS

STAR STX 80	£129.95 + VAT=£149.44
BROTHER HR 5	CALL FOR BEST PRICE
BROTHER EP 44	CALL FOR BEST PRICE

Cables - Paper - Ribbons - Sheet Feeders - Tractor
Feeds - Interfaces - Call for Best Prices



**Credit Card
HOT LINE**



01-482 1711

Please Add £10 + VAT for Delivery
Post your cheques/P.O.'s to:

DATASTAR SYSTEMS UK
UNICOM HOUSE, 182 ROYAL COLLEGE STREET,
LONDON NW1 9NN
Telex: 295931 UNICOM G

Personal callers welcome. We are situated by the junction of
Camden Road, near the railway bridge.

TAX-FREE EXPORT & DEALER ENQUIRIES WELCOME

Better by definition...

Phillips V7001 12" Tube
High Resolution Computer Monitor

**Twillstar Computers
Offer £75 INCLUSIVE!**

Size:
345mm width x 300mm depth x 302mm height!



This special V7001 Phillips monochrome computer monitor comes direct to you from Twillstar Computers Ltd at the exceptional price of £75 inclusive of VAT. Twillstar Computers Ltd have negotiated with Phillips to bring you this 12" Tube high resolution monitor which has been specially designed to display alphanumerical and graphic information, generated by home and personal computers. It offers compatibility with various types of computers, it accepts composite video signals (CVBS) as well as RGB, synchronisation and sound signals! The monitor provides a clearly legible display with a maximum of 80 characters per line and 25 lines per display. The display format is full screen 250 x 200mm. To reduce eye fatigue the picture tube has undergone a special anti-glare treatment. The monitor also features a two position, adjustable stand.

Just look at the features!

- | | |
|--|---|
| 1. 12" high resolution picture tube. | 7. Sound input 0.3 watts. |
| 2. Two position adjustable stand. | 8. 18MHz Bandwidth. |
| 3. Anti-glare treated screen. | 9. 2000 character display control. |
| 4. P31 green phosphor. | 10. Compatible with home and personal computers. |
| 5. CVBS input connections. | 11. Precision deflection unit for low geometric distortion. |
| 6. RGB and synchronisation and sound input connection. | |

And of course, exterior controls allow you to switch on/off volume, brightness, contrast, vertical size, vertical hold and horizontal size. This unique specially designed monitor measures 345mm width x 300mm depth x 302mm high. Order now while stocks last!



HOW TO ORDER

All you have to do is fill in your requirements on a piece of paper with your name and address enclosing your cheque/P.O. made payable to TWILLSTAR COMPUTERS LTD. If you are a Barclaycard or Access card holder, please use coupon and post to address below.

Please allow 14 to 28 days for delivery.

**Twillstar
Computers Limited**

17 REGINA ROAD, SOUTHALL, MIDDLESEX UB2 5PL TEL: (01) 574 5271

Wampus listing

From Page 174

0A", "10C"
 2860 DATA "11B", "10B", "1B", "6B", "11A", "11C"
 2870 DATA "12B", "2B", "6B", "7B", "12A", "12C"
 2880 DATA "13B", "3B", "7B", "8B", "13A", "13C"
 2890 DATA "14B", "8B", "9B", "4B", "14A", "14C"
 2900 DATA "15B", "9B", "5B", "10B", "15A", "15C"
 2910 DATA "16B", "6B", "17B", "20B", "16A", "16C"
 2920 DATA "17B", "7B", "16B", "18B", "17A", "17C"
 2930 DATA "18B", "17B", "8B", "19B", "18A", "18C"
 2940 DATA "19B", "18B", "9B", "20B", "19A", "19C"
 2950 DATA "20B", "19B", "10B", "16B", "20A", "20C"
 2960 DATA "1C", "2C", "5C", "11C", "1B", "0"

2970 DATA "2C", "1C", "12C", "3C", "2B", "0"
 2980 DATA "3C", "2C", "13C", "4C", "3B", "0"
 2990 DATA "4C", "3C", "14C", "5C", "4B", "0"
 3000 DATA "5C", "4C", "15C", "1C", "5B", "0"
 3010 DATA "6C", "12C", "11C", "16C", "6B", "0"
 3020 DATA "7C", "12C", "13C", "17C", "7B", "0"
 3030 DATA "8C", "13C", "14C", "18C", "8B", "0"
 3040 DATA "9C", "14C", "19C", "15C", "9B", "0"
 3050 DATA "10C", "20C", "11C", "15C", "10B", "0"
 3060 DATA "11C", "10C", "1C", "6C", "11B", "0"
 3070 DATA "12C", "2C", "6C", "7C", "12B", "0"
 3080 DATA "13C", "3C", "7C", "8C", "13B", "0"
 3090 DATA "14C", "8C", "9C", "4C", "14B", "0"

"0"
 3100 DATA "15C", "9C", "5C", "10C", "15B", "0"
 3110 DATA "16C", "6C", "17C", "20C", "16B", "0"
 3120 DATA "17C", "7C", "16C", "18C", "17B", "0"
 3130 DATA "18C", "17C", "8C", "19C", "18B", "0"
 3140 DATA "19C", "18C", "9C", "20C", "19B", "0"
 3150 DATA "20C", "19C", "10C", "16C", "20B", "0"
 3160 DATA 1,2,11,5,2,1,12,3,3,2,13,4,4,3,14,5,5,4,15,1,6,11,16,12,7,12,17,13,8,13,18,14,9,14,19,15,10,15,20,11,11,10,1,6,12,6,7,2,13,8,7,3,14,9,8,4,15,9,5,10,16,6,20,17,17,16,7,18,18,17,8,19,19,18,9,20,20,19,16,10

This listing is included in this month's cassette tape offer. See order form on Page 217.

QUAL-SOFT's contribution to the 84/85 soccer season is a 2nd generation soccer management game to suit all tastes 'DIVISION ONE '85' is an expansion of LEAGUE DIVISION ONE REV1 to new heights of sophistication in tactics/strategy games, whilst SOCCER SUPREMO offers the '3D' match simulation so much requested by those who like their mental challenge interspersed with Saturday afternoon's excitement.

"DIVISION ONE '85"

BBC 'B' only
(All O/S)

£9.95
(all inc.)
with
20 page
A5 manual

All the sophistication of LD1 REV1 (see p 131, Sept Micro User)

- Player 'psychology' (on/off days, good/bad patches)
- Press assessment of individual performances
- 'Physio's report on injury situation
- Greater choice of players for transfer
- Financial management problems 15 enhancements in all

QUAL-SOFT is committed to developing the Soccer Management idea, just as the game of computer chess is being developed, towards the most rewarding game ever played on any Micro (for soccer fans). In these two games we have taken a further giant (Quantum?) leap forward towards this GOAL!

COMBO TAPE: If you find it difficult to make up your mind why not take our combo tape with both games on one tape along with both 20 page manuals at 1½ the price, £12.95? Available by DIRECT SALES only: orders by post with cheque, ACCESS or P.O. delivered in 3-4 days! orders by telephone using ACCESS delivered in 1-2 days!

"SOCCER SUPREMO"

Electron
and
BBC 'B'
(All O/S)

£9.95
(all inc.)
with
20 page
A5 manual

The sophistication of LD1 described by Mr Bowen of Middlesbrough

... by far the best game available for the BBC Micro ...

'3D', 22 MAN FULL PITCH match simulation. Each of your 42 matches in a season played out in full on your screen (approx. 5 mins/match). No 'pre-programmed' match 'highlights': watch each match from KO to final whistle with play swinging from end to end. Tactical changes and substitutions can be made DURING THE MATCH if you, as manager, see fit.

Current owners: Send in your current LD1 or LD1 REV 1 tape with manual(s) and receive £7 off your purchase (Send £2.95 or £5.95 as appropriate)

QUAL-SOFT
 Dept. CES
 18, Hazlemere Rd.,
 Stevenage,
 Herts.
 Tel: (0438) 721936

Soccer Supremo BBC NAME:
 Division One '85 BBC ADDRESS:
 Combo tape BBC
 (In case of SS indicate
 Electron or BBC)
 ACCESS authorisation: CARD NO:

CONTRACT BRIDGE

N.B. NOT A FEEBLE ATTEMPT TO PLAY RANDOM HANDS!
BRIDGE-MENTOR is an ideal bridge partner for the BBC Micro.

- Perfect your cardplay ● Improve your bidding
- Archive interesting hands ● Create/Analyse random deals

With high resolution colour graphics and sound of the BBC Micro, **BRIDGE-MENTOR** guides you through pre-analysed hands. A host of features (including the spectacular **AUTOPLAY** option) and grand slam quiz.

- Ideal for individual **PRACTICE, ANALYSIS** and **ARCHIVING**
 - Superb teaching aid for **CLUBS** and **PROFESSIONALS**
- FOR BBC "B" and **ELECTRON** £9.50 inc. post, packing, etc

Cheques to: **MINIC BUSINESS SERVICES**
12 Woburn Close, Bushey, Herts. WD2 3XA.

J.P. MAGNETICS LIMITED

HAVING TROUBLE OBTAINING QUALITY
 COMPUTER LENGTH CASSETTES?

WE CAN SOLVE YOUR PROBLEM

10 x C15 for £4.50 + 50p P&P
 (CASH WITH ORDER)

We are specialists in the supply of bulk custom
 wound audio/computer cassettes.

Trade and Educational Enquiries Welcome.

Competitive Rates - Price List Available.

Contact us now: (0274) 731651

Unit 4, - 7 Mary Street, Bradford, BD4 8SW.

SUMMER SALE OF RGB COLOUR MONITORS

with cable for BBC Micro

Unrepeatable offer on metal cased
 units with full manufacturers'
 warranty.

14" model £180
 20" model £250
 14" High Res. model £280
 (very limited quantities only)

Also 12" High Res. green screen mono monitors at £89

VISION PRODUCTS, 9 CLAYMILL RD., LEICESTER. Tel: 352501
 (SAE for leaflet - special terms for Education Users)

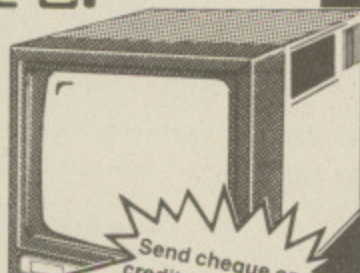

Send cheque or
 credit card number
 and allow 10 days
 for delivery

SAY GOODBYE TO GOTO!

Step by Step BASIC

BBC Micro/ Electron edition • Richard Freeman



And to the bugs and the spaghetti!
 With Step by Step BASIC you
 learn to write well-structured
 programs from day 1. Programs
 that work and that you can see will
 work. Colour, sound, graphics,
 files, sorting all included

BBC/Electron edition (203 pp) £5.95
 BBC/Electron program tape £5.50
 ZX Spectrum edition (177 pp) £5.95
 ZX Spectrum program tape £5.50

LIFELONG LEARNING LTD
 Dept EU, 55 MILTON ROAD,
 CAMBRIDGE CB4 1XA

7 COLOUR PRINTER!

Canon PJ 1080A Colour Ink-Jet Printer

The ultimate in producing print-outs
 in 7 VIVID colours!

Twillstar Computers
Offer £399 inclusive of VAT!
 Please add £8 p & p.



*Price includes
 free cable.

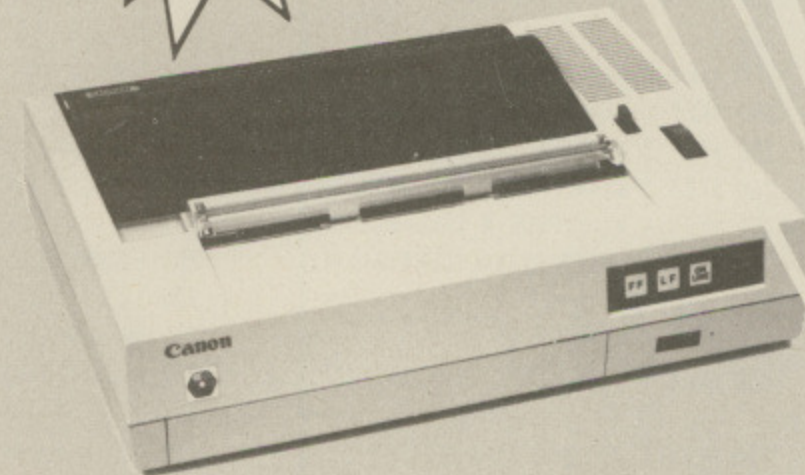

The Canon Ink-Jet Printer has many features, but its
 main feature is the capping mechanism with completely
 sealed ink supply operation! Capping prevents the ink
 from drying out and dust particles from clogging up the
 nozzles, giving you clear beautiful colour print-outs!

Office or home this is the ultimate in Colour!... at
 £399 inclusive of VAT it's worth switching right now!

The features include:

- * 7 Colour Drop on Demand ink jets.
- * 37 cps, Bi-directional printing.
- * High-resolution graphics.
- * Extremely quiet, less than 50dB.
- * Will print on acetate sheets, for overhead projection.
- * Long life ink cartridges -
- 3.5 million characters per Colour!
- * Very compact and lightweight.
- * 8-Bit Parallel int-Epson compatible.
- * Easily replaced Colour Cartridges.
- * Accepts single sheets.
- * International character sets.

HOW TO ORDER

To purchase the Canon PJ 1080A printer, simply write your
 name and address on a piece of paper, and post to the
 address below, enclosing your cheque/P.O. made payable
 to Twillstar Computers Ltd.
Credit Cards If you are a Credit Card holder, simply use the
 telephone to place your order.



**Twillstar
 Computers Limited**

17 REGINA ROAD, MIDDLESEX UB2 5P2. TEL: (01) 574 5271



Split Screen listing

From Page 94

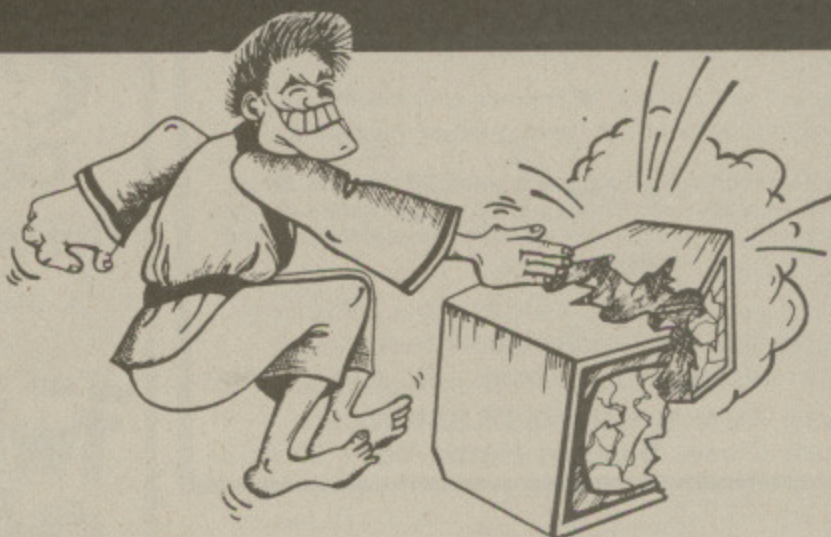

```

5 REM (c) Micro User
10 *****
20 MODEO
40 PROCINIT
60 END
70 *****
80
90 DEF PROCINIT
100 *****
110
120 CX=0:LX=7:WX=1:CLS
130 *FX219,138
140 PROCK
150
160 ENDPROC
170
180 DEF PROCK
190 *****
200
210 RESTORE350:PROCDISPLAY
220
230 *KEY 0 WX=1:PROC_W_CALL(WX):M
240 *KEY 1 WX=2:PROC_W_CALL(WX):M
250 *KEY 2 WX=3:PROC_W_CALL(WX):M
260 *KEY 3 WX=4:PROC_W_CALL(WX):M
270 *KEY 4 WX=5:PROC_W_CALL(WX):M
280 *KEY 5 G=GET:WX=VAL(CHR$(G))+1:
PROC_W_CALL(WX):M
290 *KEY 6 VX=0 :M
300 *KEY 7 LISTO LX:M LX=(LX+7)MOD1
4:M
310 *KEY 8 VDU10:M :N LIST :M
320 *KEY 9 VDU10:M :N LIST 740,:M
330 *KEY 10PROCK1:M
340
350 DATA W 0,W 1,W 2,W 3,W 4,W
0-9,(CLS),LISTO,LIST,L.n
360
370 ENDPROC
380
390 DEF PROCK1
400 *****
410
420 RESTORE540:PROCDISPLAY
430
440 *KEY 0 MO.0:PROCINIT
450 *KEY 1 RENUMBER :M
460 *KEY 2 PROCK2 :M
470 *KEY 3 RUN:M
480 *KEY 4 AUTO
490 *KEY 5 DELETE
500 *KEY 6 P."TOP=";TOP :M
510 *KEY 7 CX=(CX+1)MOD2 :M
520 *KEY 10 PROCK :M
530
540 DATA MO. 0,REN.,K2,RUN,AUTO,DEL
.,TOP,INVCX,LIST,L.n
550
560 ENDPROC
570
580 DEF PROCK2
590 *****
600
610 RESTORE690:PROCDISPLAY
620
630 *KEY 1 *EXEC"
640 *KEY 2 CH. "
650 *KEY 3 *CAT :M
660 *KEY 4 SAVE "
670 *KEY 5 *SPOOL"
680
690 DATA MO.0,*EXEC,CH.,*CAT,SAVE,
SPOOL,TOP,LISTO,LIST,L.n
700
710 ENDPROC
720
730 DEF PROCDISPLAY
740 *****
750
760 REM creates 10 windows at top o
f screen displaying key functions
770
780 VX=1:VP=VPOS
790 FOR F = 0 TO 72 STEP 8
800 PROCWINDOW(F,4,F+8-(F)DIV71,1)
810 READ A$
820 PRINTTAB(1,0);F/8;" ";TAB(1);A$
;
830 NEXT
840 VX=0:PROC_W_CALL(WX):VDU31,0,VP
850
860 ENDPROC
870
880 DEF PROC_W_CALL(W)
890 *****
900
910 REM passes one of ten predeterm
ined sets of parameters to PROCWINDOW
920
930 ON W GOSUB 950,960,970,980,990,
1000,1010,1020,1030,1040:GOTO 1060
940
950 PROCWINDOW( 0,31,79, 4):RETURN
960 PROCWINDOW( 0,31,40, 4):RETURN
970 PROCWINDOW(40,31,79, 4):RETURN
980 PROCWINDOW( 0,31,40,12):RETURN
990 PROCWINDOW(40,31,79,12):RETURN
1000 PROCWINDOW( 0,31,40,24):RETURN
1010 PROCWINDOW(40,31,79,24):RETURN
1020 PROCWINDOW( 0,12,79, 4):RETURN
1030 PROCWINDOW( 0,31,79,12):RETURN
1040 PROCWINDOW( 0,31,79,19):RETURN
1050
1060 VX=1
1070 ENDPROC
1080
1090 DEF PROCWINDOW(x,y,a,b)
1100 *****
1110
1120 COLOURCX
1130 VDU28,x,y,a,b
1140 IF VX>0 VDU17,128+CX,12
1150 VDU28,x+1,y-1,a-1,b+1
1160 IF VX>0 VDU17,129-CX,12
1170 ENDPROC
1180
1190 DEF PROCDEMO
1200 *****
1210
1220 REM: List this procedure on scr
een 1 then type PROCDEMO
1230
1240 INPUT" Do you want a black back
ground (1) or a white one (0) - (0/1)
",CX
1250 PROC_W_CALL(5)
1260
1270 FOR X=1 TO 100:PRINT" WHEN X
=";X,"X Squared =" ;X^2:NEXT
1280
1290 ENDPROC
1300
1310 REM CX controls inverse colou
rs
1320 REM LX controls LIST options
1330 REM VX = 1 when window is clear
ed
1340 REM WX = no. of text window

```

This listing is included in this month's cassette tape offer. See order form on Page 217.

COMPUTE-A-WIN

USE YOUR 'BEEB' TO SELECT WINNERS
ALL YEAR ROUND
2 COMPLETE PROGRAMS FOR THE PRICE OF 1

Side A - FLAT RACING
Side B - N/HUNT RACING

Each program covers all tracks in England & Scotland.

Each self contained program allows choice of

1. QUICK selection - using any daily newspaper (no racing knowledge required)
2. SPECIALIST selection - using information given in a popular 'Racing' paper e.g. past form, weight carried, draw advantage, trainer/jockey ratings, speed ratings etc, etc.

For BBC A/B CASSETTE ONLY £6.95

LOWMAC SOFTWARE

4 CROWLEY GARDENS, BLAYDON-ON-TYNE NE21 5EJ

THE NEXT TRAIN CALLS AT ...

Fulfil a childhood ambition and climb aboard a powerful locomotive as the driver. Your train has a schedule to keep to also as the driver you will have to obey all signals and line speeds. Your performance will be monitored throughout and an end of game score will be displayed provided that you have not been relieved of the controls for endangering passengers lives. Three games to choose from all with a variety of locomotives.

Flying Scotsman - Kings Cross to Doncaster with emphasis on high speed running.

Cornish Riviera - Paddington to Exeter with a stop at Reading.

Master Cutler - The latest in our famous trains series travelling from St. Pancras to Leicester with a fast non stop or semi fast with several stops.

for BBC "B" and Spectrum 48K
£7.50 for each game available from

DEE-KAY SYSTEMS. Dept (MU)
18 Salford Close, Woodrow South,
Redditch Worcs B98 7UN

MIRRA

● **MACHINE CODE INTERPRETER 8k EPROM £13.50.** Single step/set breakpoints in ROM/RAM. View/Edit/Disassemble/Move/Relocate. Allows 2 sets of key definitions. Lists program variables. Optional security system. (Enclose 5 digit password.)

● **UTILITY DISC £9.00.** Search and replace. List PROC/FN with line No View memory. On screen edit. Load/save to and from any disc sector. Cure bad programs etc.

● **MASTER DISC £8.00.** Step through disc sector by sector. On screen editing of any sector. View unlistable programs. Retrieve deleted files etc.

● Both the above on one disc £13.00.

● **TERMINAL Cassette £6.00. Disc £8.00.** Split xmit. and rec. Baud rates. Parity, stop and word length. Spool and Exec files. 40/80 chars. Split screen facility. Xon/Xoff protocols. Save and load configuration. Printer control.

SAE for full details of all the above. All prices include VAT and P&P.

WE ARE ALWAYS INTERESTED IN ORIGINAL
GAME/UTILITY/BUSINESS PROGRAMS WHY NOT SEND US
YOURS. A QUICK DECISION
ALWAYS GIVEN.

MIRRA SYSTEMS, 24 Kirkstone, Rugby, Warwickshire, CV21 1PV.

Also available at The Micro Centre, Regent Street, Rugby.
All programs require 1.2 DS. Discs require Acorn DFS.

BBC POOLS PREDICTOR

WITH 11,000 MATCH DATABASE

Now in its 3rd successful season, Mayday Software's Pools Predictor has been made even more powerful with a new and unique 11,000 match database. Seven separate forecasting techniques have been combined to give you the best forecasts yet. And, just as easy to use, is our new Racing Analyser. This uses the racecard from your daily paper to analyse any horse race - and it's yours for no extra charge!

***** ALSO AVAILABLE FOR THE SPECTRUM *****

MAYDAY SOFTWARE 181 Portland Crescent
Stanmore, Middx. HA7 1LR.

FREE RACING ANALYSER

BOTH PROGRAMS
FOR ONLY

£8.99

Canon PW-1080A Wire Dot Printer

A Printer with Flexibility and
Real Impact ...

Twillstar Computers Offer £289 INCLUSIVE!

Telephone
Orders
574 5271

*Price includes free
printer cable



... If you are looking for high-speed, high quality printing in one compact unit, then this Canon PW-1080A unit is for you. Couple that with the special fully inclusive Twillstar offer price of £289, and you have a really exceptional bargain!

The features include:

- * High speed printing: 160 characters per second
- * Bi-directional, logical seeking
- * Quiet operation: less than 60dB
- * High-resolution graphic printing: N x 16 dot matrix
- * Down loading for user-optional characters

- * 4 character styles printable on the same line
- * Superscript and subscript available
- * International character sets selectable
- * Selectable line feeding: 1/8" and programmable
- * Handles; roll paper, fanfold, single sheet and multipart copy paper

HOW TO ORDER

To purchase the Canon PW-1080A printer, simply write your name and address on a piece of paper, and post to the address below, enclosing your cheque/P.O. made payable to Twillstar Computers Ltd.

If you are a Credit Card Holder, simply use the telephone to place your order.

TCL

Twillstar Computers Limited

17 REGINA ROAD, SOUTHALL, MIDDLESEX UB2 5PL. TEL: (01) 574 5271

A SUPER VALUE 12" GREEN SCREEN MONITOR FOR THE BEEB!

That's right a good quality 12" green screen monitor for only £79.00 - it is fully supported by U-Microcomputers and available through your local dealer.

Technical specs: 12" green screen, 90° deflection, composite video input, 15 MHz bandwidth. Use it with Apple, BBC micro or with most of the popular micros, for 40 column, 80 column or mono graphics.

To order:
5-1020 U-VIEW 12" green monitor.
Prices exclude VAT & delivery

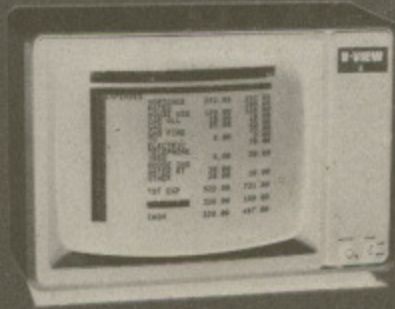

£79.00

U-MICRO

U-Microcomputers Ltd
Winstanley Industrial Estate, Long Lane
Warrington, Cheshire WA2 8PR
Tel: 0925 54117 Telex 629279 UMICROG

Ask about quantity prices!

TSL Tutorial Software Ltd.

SENIOR SCHOOL EDUCATIONAL PROGRAMS

Developed in schools and now available to interested home micro users. Research has identified the compulsory exam topics, and professional programmers have coded these into exciting educational games which have been proven to effectively teach and entertain.

Now available for BBC B and ELECTRON. Each pack contains main program, extra self test program and Core Facts book for only £11.95 or any two for £19.95.

MATHS 1: TRY-ANGLES	Draughts style teaches angles ratios, tan, sin, cos. 25 levels
MATHS 2: COORDINATES	Battleship style teaches x and y in four sectors, directed numbers
PHYSICS 1: OHM RUN:	Baseball style teaches D.C. circuits, resistors, cells, V-IR, series and parallel.
PHYSICS 2: ISAAC	Gunnery style teaches mass, weight Newtons Laws and projectiles
GEOGRAPHY 1: MAYDAY	Orienteering style teaches O.S. symbols, grid references, bearings
GEOGRAPHY 2: WEATHER	Forecasting style teaches symbols, pressure systems, synoptic charts

Send your name, address, and cheque/P.O. to **DEPT. M.**
TUTORIAL SOFTWARE LTD., FREEPOST, WIRRAL, MERSEYSIDE L61 1AB.
Please state BBC B or ELECTRON

CARE ELECTRONICS

UNIT 14, PEERGLow INDUSTRIAL ESTATE, OLD'S APPROACH, TOLPITS LANE, RICKMANSWORTH, HERTS.
TELEPHONE: 0923 777155 01 950 0195

CARE ELECTRONICS PRESENTS: CPX2 "X" SWITCHER

CHANGING LEADS BECOMES A THING OF THE PAST!!!

- 26pin (As BBC) 2 Micros driving 2 Printers at the same time.
- Can be used as a "T" Switcher.
- All outputs BUFFERED enabling longer leads between units.
- No strain on your BBC power supply, as the "CPX2" comes complete with its own internal power supply.
- Easy to install and operate.
- Colour Finished to match BBC.
- Supplied with moulded mains plug.
- 12 Months Guarantee.

"ONLY" £97.75 Inc VAT.

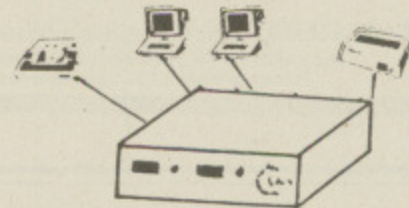

"VIGLEN"

ROM CARTRIDGE SYSTEM

Complete Set	£18.95 inc VAT
Spare Cartridge	£6.75 inc VAT
5 Cartridges	£26.75 inc VAT
10 Cartridges	£47.25 inc VAT

RS232 SWITCHERS:

"T"	£55.00 Inc VAT
"X"	£65.00 Inc VAT

HOW TO ORDER

By post. Enclose Cheque/P.O. made payable to CARE Electronics.
Or use ACCESS. Allow 7 days for delivery. Please add carriage.
CPX2 £8.00 Other items £3.00.

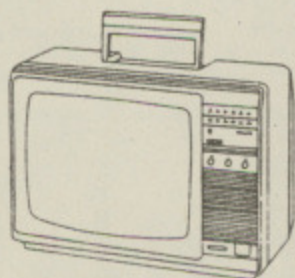

DON'T BUY A COLOUR MONITOR! HAVE YOUR PHILIPS 14" COLOUR TV CONVERTED TO A TV/MONITOR

"ONLY" £49.95 each inc VAT.

- * Image clarity comparable to leading monitors.
- * Includes RGB lead for connecting with BBC.
- * Conversions carried out at our workshops within 2/3 days.
- * 12 Months Guarantee.

Escape the Goulogs listing

From Page 115

```

10 REM*****
20 REM**  ESCAPE THE GOULOGS  **
30 REM**      BY      **
40 REM**    PHIL BROOKS    **
50 REM**    (c) Micro User  **
60 REM*****
70 HI1%=1000:HI2%=2000:HI3%=3000:H
14%=4000:HI5%=4000
80 ONERRORGOTO90
90 MODE7:VDU 23;8202;0;0;0;
100 PROCINST
110 MODE5
120 SX=0:BDX=0:I=0:LIVX=6:ZX=0
130 VDU19,3,1+LEVX,0,0,0
140 VDU19,2,2+LEVX,0,0,0
150 IFM<5THENGOTO190
160 :FLIVX=0THENPROCEND
170 COLOUR2:VDU23;8202;0;0;0;:PRINT
TAB(6,16);"LEVEL ";LEVX;:COLOUR1
180 FORF=0TO5000:NEXT:CLS
190 ENVELOPE1,1,0,0,0,0,0,60,-5,-
2,-3,120,40
200 ENVELOPE2,4,0,0,0,0,0,20,-14,-
-8,-8,120,50
210 *FX4,1
220 VDU23,224,0,3,7,7,15,15,15,15,2
3,225,0,192,224,224,240,240,240,240,2
3,226,15,15,15,15,7,7,3,0,23,227,240,
240,240,240,224,224,192,0,23,228,0,60
,126,126,255,255,255,255,23,229,255,2
55,255,255,126,126,60,0
230 VDU23,230,8,8,4,4,2,2,1,1,23,23
1,128,128,64,64,32,32,16,16,23,232,12
8,128,128,128,64,64,64,64,23,233,32,3
2,32,32,16,16,16,16,23,234,8,8,8,8,8,
8,8,8,23,236,4,4,4,4,8,8,8,23,237,1
,1,1,1,2,2,2,2,23,238,16,16,32,32,64,
64,128,128
240 VDU23,239,1,1,2,2,4,4,8,8,23,24
0,24,60,60,60,60,60,60,24,23,241,16,1
6,32,32,64,64,128,128
250 VDU23,242,1,3,7,15,15,31,31,31,
23,243,31,31,15,15,9,9,31,31,23,244,3
1,31,63,63,63,127,127,127,23,245,31,3
1,31,63,63,31,63,63,23,246,31,31,31,1
5,15,7,7,3
260 VDU23,247,192,48,12,195,51,12,4
8,192,23,248,128,192,224,240,240,248,
248,248,23,249,248,248,240,240,144,14
4,248,248,23,250,248,248,252,252,252,
254,254,254,23,251,248,248,248,252,25
2,248,252,252,23,252,248,248,248,240,
240,224,224,192
270 VDU23,253,3,12,48,195,204,48,12
,3
280 VDU23;8202;0;0;0;
290 PROCMAP
300 PROCFACE1(12,3):PROCFACE1(19,21

```

```

)
310 IFLEVX>2THENPROCFACE2(2,3)
320 PROCSTART
330 FORBX=0TO4
340 CX=BX-1
350 PROCBCHECK
360 ZX=ZX+1
370 IFZX>40-4*LEVXANDCX<>-1THENPROC
BBANG
380 FORF=0TO100-33*(LEVX-1):NEXT
390 PROCBAL1
400 PROCSTR1
410 IFLEVX>2ANDXX<3+LEVXANDXX>2ANDY
X=5THENPROCBLWCHECK2(3,6)
420 NEXTBX
430 PROCMOVER1
440 *FX15,1
450 FORBX=4TO0STEP-1
460 CX=BX+1
470 PROCBCHECK
480 ZX=ZX+1
490 IFZX>40-4*LEVXANDCX<>5THENPROCB
BANG
500 FORF=0TO100-33*(LEVX-1):NEXT
510 PROCBAL2
520 PROCSTR2
530 IFXX>9-LEVXANDXX<10ANDYX=5THENP
ROCBLOWCHECK1(11,6)
540 IFXX>16-LEVXANDXX<17ANDYX=23THE
NPROCBLWCHECK1(18,24)
550 NEXTBX
560 PROCMOVER2
570 *FX15,1
580 IFXX=16ANDYX=1THENPROC60AL:IFM<
=5THENGOTO130
590 GOTO330
600 DEFPROCBAL1
610 IFBX=0THENPRINTTAB(X%,Y%);CHR$2
28;:VDU10,8,229:ENDPROC
620 IFBX=1THENPRINTTAB(X%,Y%);CHR$2
24;:VDU225,10,8,8,226,227:ENDPROC
630 IFBX=2THENPRINTTAB(X%+1,Y%);CHR
$228;:VDU10,8,229:PRINTTAB(X%,Y%);CHR
$32;:VDU10,8,32:ENDPROC
640 IFBX=3THENPRINTTAB(X%+1,Y%);CHR
$224;:VDU225,10,8,8,226,227:ENDPROC
650 IFBX=4THENPRINTTAB(X%+2,Y%);CHR
$228;:VDU10,8,229:PRINTTAB(X%+1,Y%);C
HR$32;:VDU10,8,32
660 ENDPROC
670 DEFPROCBAL2
680 IFBX=0THENPRINTTAB(X%,Y%);CHR$2
28;:VDU10,8,229:PRINTTAB(X%+1,Y%);CHR
$32;:VDU10,8,32:ENDPROC
690 IFBX=1THENPRINTTAB(X%,Y%);CHR$2
24;:VDU225,10,8,8,226,227:ENDPROC
700 IFBX=2THENPRINTTAB(X%+1,Y%);CHR
$228;:VDU10,8,229:PRINTTAB(X%+2,Y%);C
HR$32;:VDU10,8,32:ENDPROC
710 IFBX=3THENPRINTTAB(X%+1,Y%);CHR

```

```

$224;:VDU225,10,8,8,226,227:ENDPROC
720 IFBX=4THENPRINTTAB(X%+2,Y%);CHR
$228;:VDU10,8,229
730 ENDPROC
740 DEFPROCSTR1
750 IFBX=0THENPRINTTAB(X%,Y%+2);CHR
$230;:VDU10,231:ENDPROC
760 IFBX=1THENPRINTTAB(X%+1,Y%+2);C
HR$232;:VDU10,8,233:PRINTTAB(X%,Y%+2)
;CHR$32;:ENDPROC
770 IFBX=2THENPRINTTAB(X%+1,Y%+2);C
HR$234;:VDU10,8,234:ENDPROC
780 IFBX=3THENPRINTTAB(X%+1,Y%+2);C
HR$237;:VDU10,8,236:ENDPROC
790 IFBX=4THENPRINTTAB(X%+2,Y%+2);C
HR$238;:VDU10,8,8,239:PRINTTAB(X%+1,Y
%+2);CHR$32;
800 ENDPROC
810 DEFPROCSTR2
820 IFBX=0THENPRINTTAB(X%,Y%+2);CHR
$230;:VDU10,231:PRINTTAB(X%+1,Y%+2);C
HR$32;:ENDPROC
830 IFBX=1THENPRINTTAB(X%+1,Y%+2);C
HR$232;:VDU10,8,233:ENDPROC
840 IFBX=2THENPRINTTAB(X%+1,Y%+2);C
HR$234;:VDU10,8,234:ENDPROC
850 IFBX=3THENPRINTTAB(X%+1,Y%+2);C
HR$237;:VDU10,8,236:PRINTTAB(X%+2,Y%+
2);CHR$32;:ENDPROC
860 IFBX=4THENPRINTTAB(X%+2,Y%+2);C
HR$238;:VDU10,8,8,239
870 ENDPROC
880 DEFPROCMAP
890 RESTORE
900 LOCALA,B,C,D,E
910 GCOL0,2:FORG=1TO19:READA,B,C,D,
E
920 MOVEA,B:DRAWA,C:PLOT85,D,C:PLOT
85,D,B:PLOT85,A,B
930 SOUND1,-15,E,2
940 NEXT:ENDPROC
950 DATA0,0,118,1279,53,0,118,1023,
54,61,54,490,1024,118,69,118,554,1024
,182,77,182,874,1024,246,85,246,938,1
023,778,93,778,426,1023,950,101,842,3
62,426,950,93,906,298,362,950,85,950,
298,470,1014,77
960 DATA950,842,1023,1014,69,1014,1
902,1023,1279,61,1226,118,1002,1279,5
3,1162,618,694,1226,61,266,330,374,39
4,69,394,118,726,502,77,502,118,630,5
66,85
970 DATA566,118,278,630,93,630,118,
214,694,101
980 DEFPROCBCHECK
990 IFBX=0ORBX=2ORBX=4 THENGOTO1030
1000 IFPOINT(64*(X%+BXDIV2),1023-32*
Y%)=2 ORPOINT(64*(X%+BXDIV2),1023-32*

```

teletext

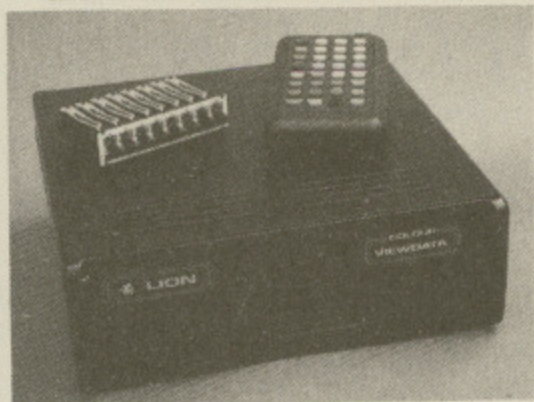

& PRESTEL

NOW AT LAST a Teletext and Prestel combined unit for the BBC micro. The Teletext has even greater performance. With this unit you can see the picture as well as the text, subtitles, etc. The Prestel is not just a modem but full autodial, I.D. etc. Telesoftware can be obtained from both medium's.

TELETEXT PRESTEL MXV05 only £198

TELETEXT ONLY £179

PRESTEL ONLY £75

All prices include software cables etc.
(Specify 40/80 track if disc required) SAE for information please.

LION VIEWDATA

18 Harcourt Terrace, London SW10

THE Voxbox Recognises Voice, Too

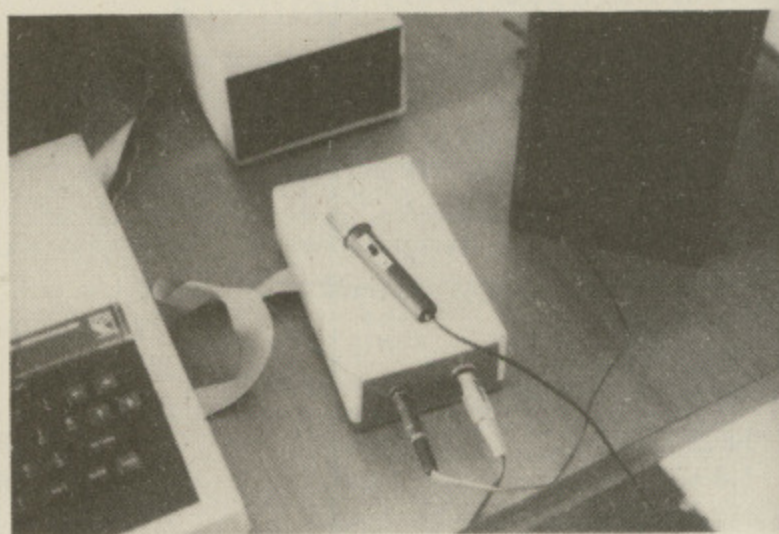

The Voxbox has a new capability. As before, normal human voice can be stored on disc and accessed from your own programmes. Now also, the same Voxbox can be used for Voice Recognition. Make your BBC Speak AND Understand. Complete system **£97.00 all inc.**

SYSTEMS CAN BE PURCHASED SEPARATELY

For information and sales, please contact:

Multiplex Computer Services

250, Eastern Road, Brighton BN2 5TA.

Tel: (0273) 606860

See our programs on MICRONET 800

PERSONAL
COMPUTER
SOFTWARE

Proxima

Beeb-Text Features:
width
Height
Italic

FONTS

ONE FIVE
THREE SIX
FOUR SEVEN
EIGHT

BEEB-TEXT

A sophisticated and unique machine-code program which allows virtually unlimited variation in the BBC's text display. The user has the option of varying character thickness, italic, styles, height, width, colour combinations, etc. Up to 8 different fonts can be displayed in one page including shadowed and outlined types. Beeb-Text displays text in proportional spacing too however the user can also control character and line spacing independently.

Disc £15.00

▲Prices are fully inclusive, no extra to pay.
▲P&P on all orders is FREE!
▲Please make cheques/P.O.'s payable to PROXIMA SOFTWARE.

BIG Print

(c) Proxima Software

Very tall text as well as normally sized text

THINK BIG *

A highly effective machine-code program for displaying any dimension text. Can be incorporated into other programs.

Cassette £5.95
Disc £8.95

PIXEL PACKAGE *

Two programs are supplied for designing single colour and multi-colour characters and designs can be mirrored, inverted, rotated and duplicated. The programs even store the resulting data in program lines ready to be used.

Cassette £6.95
Disc £9.95

TWO PLAYER GAMES *
Two 2-player games including 4Line and Frustration, joystick compatible.

Cassette £7.95
Disc £10.95

DISC TOOLS The complete utility disc for twin 80 track drive users and includes a 40/80 or 40/40 or 80/40 backing up facility.

Disc £10.95

ROBOBRAIN Arcade fun. Disable the robot's positronic brain but watch out for its self defence.
Cassette £7.95
Disc £10.95



Our FREE program special offer continues. Contact us for details!

PROXIMA PERSONAL COMPUTER SOFTWARE,
Newlands, 30 Sparelease Hill, Loughton, Essex, IG10 1BT.
Please specify 40 or 80 track or 3" types when ordering discs.

Tel. 01-502-0230

Escape the Goulogs listing

From Page 181

```

(YZ+2))=2 ORPOINT(64*(XZ+2+BZDIV2),10
23-32*YZ)=2 ORPOINT(64*(XZ+2+BZDIV2),
1023-32*(YZ+2))=2 ORPOINT(64*(XZ+2+BZ
DIV2),1023-32*(YZ+1))=2 THENPROCBBANG

1010 IFXZ=2ANDYZ<7ANDPOINT(64*(XZ-.5
+BZDIV2),1023-32*YZ)=2 THENPROCBBANG
1020 IFPOINT(64*(XZ+1.5+BZDIV2),1023
-32*YZ)=2 ORPOINT(64*(XZ+1.5+BZDIV2),
1023-32*(YZ+2))=2 THENPROCBBANG:GOTO1
040
1030 IFPOINT(64*(XZ+BZDIV2),1023-32*
YZ)=2 ORPOINT(64*(XZ+(BZ+2)DIV2),1023
-32*YZ)=2 ORPOINT(64*(XZ+BZDIV2),1023
-32*(YZ+2))=2 ORPOINT(64*(XZ+(BZ+2)DI
V2),1023-32*(YZ+2))=2 ORPOINT(64*(XZ+
(BZ+2)DIV2),1023-32*(YZ+1))=2 THENPRO
CBBANG
1040 IFPOINT(64*(XZ+1),1023-32*(YZ+3
))=2 ORPOINT(64*(XZ+2),1023-32*(YZ+3)
)=2 ORPOINT(64*(XZ+1),1023-32*(YZ+4)
)=2 ORPOINT(64*(XZ+2),1023-32*(YZ+4))=
2 THENPROCBBANG
1050 IFBZ=0 ANDPOINT(64*(XZ+.5),1023
-32*(YZ+3))=2 THENPROCBBANG
1060 IFBZ=4 ANDPOINT(64*(XZ+2.5),102
3-32*(YZ+3))=2 THENPROCBBANG
1070 ENDPROC
1080 DEFPROCMOVECHECK1
1090 IFI<>136THENGOTO1120
1100 IFPOINT(64*(XZ+2),1023-32*YZ)=2
ORPOINT(64*(XZ+2),1023-32*(YZ+2))=2
ORPOINT(64*(XZ+1),1023-32*(YZ+3))=2 T
HENPROCBBANG1(XZ+3,YZ):ENDPROC
1110 IFXZ=1ANDYZ<5ANDPOINT(64*(XZ+.5
),1023-32*(YZ+3))=2 THENPROCBBANG1(XZ+
3,YZ)
1120 IFI<>137THENGOTO1150
1130 IFPOINT(64*(XZ+2.5),1023-32*(YZ
+3))=2 ORPOINT(64*(XZ+2.5),1023-32*YZ
)=2 ORPOINT(64*(XZ+2.5),1023-32*(YZ+2
))=2 ORPOINT(64*(XZ+1.5),1023-32*(YZ+
4))=2 ORPOINT(64*(XZ+2.5),1023-32*(YZ
+1))=2 THENPROCBBANG1(XZ+1,YZ):ENDPROC
1140 IFXZ=10ANDYZ<5ANDPOINT(64*(XZ+3
.5),1023-32*YZ)=2 THENPROCBBANG1(XZ+1,
YZ)
1150 IFI<>65THENGOTO1170
1160 IFPOINT(64*(XZ+2),1023-32*YZ)=2
ORPOINT(64*(XZ+3),1023-32*YZ)=2 DRPO
INT(64*(XZ+1),1023-32*(YZ+3))=2 THENP
ROCBANG1(XZ+2,YZ+1):ENDPROC
1170 IFI<>90THENENDPROC
1180 IFPOINT(64*(XZ+2),1023-32*(YZ+4
))=2 ORPOINT(64*(XZ+3),1023-32*(YZ+3)
)=2 ORPOINT(64*(XZ+1),1023-32*(YZ+4)
)=2 THENPROCBBANG1(XZ+2,YZ-1):ENDPROC
1190 ENDPROC

1200 DEFPROCBBANG2(XBZ,YBZ)
1210 SOUND0,1,5,1
1220 PRINTTAB(XBZ,YBZ);CHR$32;:VDU10
,127,10,9,127,10,9,9,127
1230 PROCSTART
1240 ENDPROC
1250 DEFPROCBBANG
1260 SOUND0,1,5,1
1270 IFCX=0 THENPRINTTAB(XZ+1,YZ);CH
R$127;:VDU10,9,127,10,9,127,10,9,9,12
7
1280 IFCX=1THENPRINTTAB(XZ+2,YZ);CHR
$127;:VDU127,10,9,9,127,127,10,9,9,12
7,10,9,127
1290 IFCX=2THENPRINTTAB(XZ+2,YZ);CHR
$127;:VDU10,9,127,10,9,127,10,9,127
1300 IFCX=3THENPRINTTAB(XZ+3,YZ);CHR
$127;:VDU127,10,9,9,127,127,10,9,127,
10,9,127
1310 IFCX=4 THENPRINTTAB(XZ+3,YZ);CH
R$127;:VDU10,9,127,10,9,127,10,127
1320 COLOUR0:XZ=1:YZ=24:COLOUR1:PROC
START
1330 ENDPROC
1340 DEFPROCBBANG1(XAZ,YAZ)
1350 SOUND0,1,5,1
1360 PRINTTAB(XAZ,YAZ);CHR$32;:VDU10
,127,10,9,127,10,127
1370 PROCSTART
1380 ENDPROC
1390 DEFPROCMOVECHECK2
1400 IFI<>136THENGOTO1430
1410 IFPOINT(64*(XZ+.5),1023-32*YZ)=
2 ORPOINT(64*(XZ+.5),1023-32*(YZ+2))=
2 ORPOINT(64*(XZ+1.5),1023-32*(YZ+4)
)=2 THENPROCBBANG2(XZ+1,YZ):ENDPROC
1420 IFXZ=2ANDYZ<8ANDPOINT(64*(XZ-.5
),1023-32*YZ)=2 THENPROCBBANG2(XZ+1,YZ
)
1430 IFI<>137THENGOTO1450
1440 IFPOINT(64*(XZ+1),1023-32*YZ)=2
ORPOINT(64*(XZ+2),1023-32*(YZ+3))=2
ORPOINT(64*(XZ+1),1023-32*(YZ+2))=2 O
RPOINT(64*(XZ+2),1023-32*(YZ+4))=2 OR
POINT(64*(XZ+1),1023-32*(YZ+1))=2 THE
NPROCBBANG2(XZ-1,YZ):ENDPROC
1450 IFI<>65THENGOTO1470
1460 IFPOINT(64*XZ,1023-32*YZ)=2 DRP
OINT(64*(XZ+1),1023-32*YZ)=2 ORPOINT(
64*(XZ+2),1023-32*(YZ+3))=2 THENPROCB
ANG2(XZ,YZ+1):ENDPROC
1470 IFI<>90THENENDPROC
1480 IFPOINT(64*XZ,1023-32*(YZ+3))=2
ORPOINT(64*(XZ+1),1023-32*(YZ+4))=2
ORPOINT(64*(XZ+2),1023-32*(YZ+4))=2 T
HENPROCBBANG2(XZ,YZ-1):ENDPROC
1490 ENDPROC
1500 DEFPROCGOAL
1510 LOCALX,Y
1520 RESTORE1540

1530 FORP=1TO10:READX,Y:SOUND1,-15,X
,Y:NEXTP
1540 DATAB1,5,89,5,97,5,101,10,81,10
,101,5,97,5,101,5,109,10,89,10
1550 FORW=0TO5
1560 COLOUR1:PRINTTAB(15,7);"GOAL";
1570 FORF=0TO300:NEXT
1580 COLOUR0:PRINTTAB(15,7);" ";
1590 FORF=0TO300:NEXT
1600 NEXTW
1610 COLOUR1
1620 IFTIME<3000THENBONX=1000*LEVZ:P
RINTTAB(11,23);"YOU WERE";TAB(10,24);
"VERY FAST";TAB(11,25);"BONUS";TAB(12
,26);"=";BONX;:LIVZ=LIVZ+1
1630 IFTIME<6000ANDTIME>=3000THENBON
X=500*LEVZ:PRINTTAB(11,23);"YOU WERE"
;TAB(12,24);"FAST";TAB(12,25);"BONUS"
;TAB(12,26);"=";BONX;:LIVZ=LIVZ+1
1640 IFTIME>=6000THENBONX=0:PRINTTAB
(11,23);"YOU WERE";TAB(11,24);"TOO SL
OW";TAB(11,25);"BONUS=";BONX;:LIVZ=LI
VZ+1
1650 SX=SX+BONX:PRINTTAB(7,29);SX;:I
FMX=5THENLEVZ=LEVZ+1:IFLEVZ>4THENLEVZ
=4
1660 FORF=0TO5000:NEXT:IFMX=5THENCLS
:ENDPROC
1670 IFMX<5THENPRINTTAB(XZ,YZ);CHR$3
2;:VDU10,127,10,9,127,10,9,9,127:PRIN
TTAB(11,23);CHR$32;:VDU32,32,32,32,32
,32,32,10,127,127,127,127,127,127,127
,127,127,10,9,32,32,32,32,32,32,32,32
,10,127,127,127,127,127,127,127:PROCS
TART
1680 DATA69,5,69,5,77,5,77,5,81,5,81
,5,89,10,97,10,97,5,97,15,97,5,101,5,
97,10,89,5,89,5,81,5,81,5,77,10,69,10

1690 ENDPROC
1700 DEFPROCFACE2(XF2Z,YF2Z)
1710 COLOUR3
1720 PRINTTAB(XF2Z,YF2Z);CHR$248;:VD
U32,10,127,8,249,10,8,250,10,8,251,10
,8,252
1730 COLOUR1
1740 ENDPROC
1750 DEFPROCBLOW1(A1Z,B1Z)
1760 SOUND0,2,4,10
1770 COLOUR1:PRINTTAB(A1Z,B1Z);CHR$2
47;
1780 FORF=1TO300:NEXT:PRINTTAB(A1Z,B
1Z);CHR$32;
1790 WX=XZ
1800 IFPOINT(64*WX,1023-32*YZ)=2 DRP
OINT(64*WX,1023-32*(YZ+2))=2 ORPOINT(6
4*(WX+1),1023-32*(YZ+4))=2 ORPOINT(6
4*WX,1023-32*(YZ+3))=2 THENPROCBBANG2(

```

LARGEST COMPUTER CENTRE
in
MANCHESTER

BBC, COMMODORE, MEMOTECH, SINCLAIR,
SHARP, SANYO DEALERS

AMSTRAD IN STOCK

BBC MICRO

BBC B (Free Recorder & Games)	£399
Electron	£199
6502 Second Processor	£199
Z80 Second Processor	£299
Bitstick System	£374

PRINTERS

Shinwa CP80 CTI	£219
Olivetti JP101	£155
Star Gemini 10X	£229
Juki 6100	£388
Epson RX80 FT	£289
Cannon 1080	£339
Cosmos 80	£199

MONITORS

Sanyo 12N	£89
Philips	£89
Microvitec	£229
Microvitec Medium	£275
Sanyo Medium	£227
Fidelity	£217
JVC Medium	£199
JVC High	£272

DISK DRIVES

Opus, Pace, Cumana

ACCESSORIES

Wordwise	£39.95
VIEW	£59.95
Grafpad	£143.75
Sideways ROM	£45
Graphics ROM	£33
Disc Doctor	£33

COMPUTER STATIONERY, DISKS, PLUGS, SOCKETS, CABLES, ETC.
TELEPHONE ANSWERING MACHINES/CORDLESS PHONES: NOW IN STOCK

Wide range of books, software (educational software specialist).
Showroom, demonstration facility. Prices include VAT, all items
available mail order. Personal Export scheme.

Suppliers to Universities and all leading Schools



MIGHTY MICRO



SHERWOOD CENTRE
268 WILMSLOW ROAD
FALLOWFIELD, MANCHESTER
TEL: 061-224 8117

Harrier

BBC/ELECTRON*

Compatible Joystick

£10⁹⁵ Include VAT and P&P

Special Features:

1. Firm grip handle
2. Self centring
3. Dual fire buttons
4. Plug direct into A/D socket –
no software/interface required
5. Suitable for most joystick
games
6. Rugged construction for
durability



Available from all good
BBC Computer Dealer
and Chain Stores. Or
mail order only from:

TRADELINK UK
Dept. MU 21 Broughton St.
Edinburgh EH1 3JU.

Tel: 031 557 4138

Distributor/Dealer enquiries welcome.

*Electron requires joystick
interface to use joystick

Disk Drives for the Micro user –

Stacom Distribution Ltd, are main
distributors for Datafax Disk Drives
in the U.K.

Whatever your needs . . . talk to us.

An amazing range of top
quality drives, supplied
with leads, cables and
utility disks from a single
100K (200K flipable disk)

with or without
power supply unit, right
through to a dual 400K,
double sided unit (800K
double density) with power
supply unit.

We also distribute
a complete range
of 5 1/4" disk drives.

All finished in an
attractive metal
case to match
your BBC

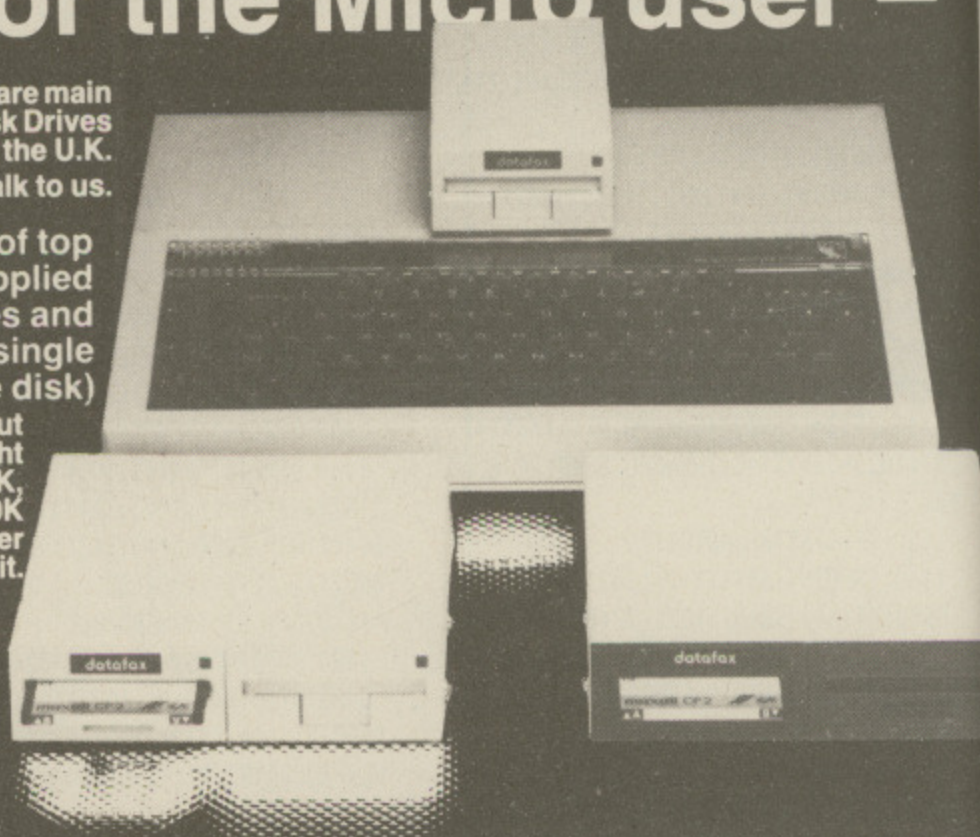

See us at the
P.C.W. Show
Olympia 2
19th-23rd
September
Stand 1045

Please send me

- Full Brochure
3" Tech Details
Dealer Info.
(Dealers attach letterhead)

Name

Address

Tel. No.

M/U



Prices from £167 plus VAT

STACOM DISTRIBUTION LTD,
18 GROVE ROAD, SUTTON, SURREY
Telephone 01 661-2266

Escape the Goulogs listing

From Page 183

```

WX+1,YZ):ENDPROC
1810 PRINTTAB(WX,YZ);CHR$228;VDU10,
8,229,10,8,230,10,231
1820 PRINTTAB(WX+1,YZ);CHR$32;VDU32
,10,127,127,10,32,32,10,127
1830 WX=WX-1
1840 IFWX=XX-3-Q*LEVZ DRINKEY(-122)
THENBZ=0:XX=WX+1:ENDPROC
1850 GOTO1800
1860 ENDPROC
1870 DEFPROCFACE1(XF1Z,YF1Z)
1880 COLOUR3
1890 PRINTTAB(XF1Z,YF1Z);CHR$242;VD
U10,8,243,10,8,244,10,8,245,10,8,246
1900 COLOUR1
1910 ENDPROC
1920 DEFPROCBLow2(A2Z,B2Z)
1930 SOUND0,2,4,10
1940 COLOUR1;PRINTTAB(A2Z,B2Z);CHR$2
53;
1950 FORF=1TO300:NEXT:PRINTTAB(A2Z,B
2Z);CHR$32;
1960 WX=XX
1970 IFPOINT(64*(WX+3),1023-32*YZ)=2
ORPOINT(64*(WX+3),1023-32*(YZ+2))=2
ORPOINT(64*(WX+3),1023-32*(YZ+3))=2 O
RPOINT(64*(WX+2),1023-32*(YZ+4))=2 TH
ENPROCBAng1(WX+1,YZ):ENDPROC
1980 PRINTTAB(WX+2,YZ);CHR$228;VDU1
0,8,229,10,8,238,10,8,8,239
1990 PRINTTAB(WX,YZ);CHR$32;VDU32,1
0,127,127,10,32,32,10,8,127
2000 WX=WX+1
2010 IFWX=XX+3-Q*LEVZ DRINKEY(-26) T
HENBZ=4:XX=WX-1:ENDPROC
2020 GOTO1970
2030 ENDPROC
2040 DEFPROCLIVES
2050 LIVZ=LIVZ-1
2060 PRINTTAB(13+LIVZ,29);CHR$32;VD
U10,127
2070 ENDPROC
2080 DEFPROCMOVER1
2090 I$=INKEY$(0):I=ASC(I$)
2100 IFI=136THENXX=XX-1 ELSEGOTO2200
2110 IFXX>2ANDXX<9ANDXX<6THENSZ=SZ-5
*LEVZ
2120 IFXX>9ANDXX<16ANDXX>22THENSZ=SZ
-5*LEVZ
2130 SOUND1,-15,100,1
2140 PROCMOVECHECK1
2150 PRINTTAB(XX+3,YZ);CHR$32;VDU10
,127,10,9,127,10,127
2160 PRINTTAB(7,29);SZ;TAB(XX+2,YZ);
CHR$228;VDU10,8,229,10,8,238,10,8,8,
239
2170 ZX=0
2180 PROCDEL

```

```

2190 IFINKEY(-26)THENGOTO2100
2200 IFI=137THENXX=XX+1 ELSEGOTO2310
2210 IFYZ>17ANDYZ<25ANDYZ>16THENXX=1
6:ENDPROC
2220 IFXX>3ANDXX<10ANDXX<6THENSZ=SZ+
5*LEVZ
2230 IFXX>10ANDXX<17ANDXX>22THENSZ=S
Z+5*LEVZ
2240 SOUND1,-15,100,1
2250 PROCMOVECHECK1
2260 PRINTTAB(XX+1,YZ);CHR$32;VDU10
,127,10,9,127,10,127
2270 PRINTTAB(7,29);SZ;TAB(XX+2,YZ);
CHR$228;VDU10,8,229,10,8,238,10,8,8,
239
2280 ZX=0
2290 PROCDEL
2300 IFINKEY(-122)THENGOTO2200
2310 IFI=65THENYZ=YZ-1 ELSEGOTO2460
2320 IFYZ<1THENYZ=1
2330 IFXX>0ANDXX<6ANDXX>4THENSZ=SZ+5
*LEVZ
2340 IFXX>14ANDXX<19ANDXX<23ANDXX>1T
HENSZ=SZ+5*LEVZ
2350 IFXX>7ANDXX<14ANDXX<24ANDXX>2TH
ENSZ=SZ-5*LEVZ
2360 SOUND1,-15,100,1
2370 PROCMOVECHECK1
2380 PRINTTAB(XX+1,YZ+4);CHR$32;VDU
11,32
2390 PRINTTAB(7,29);SZ;TAB(XX+2,YZ);
CHR$228;VDU10,8,229,10,8,238,10,8,8,
239
2400 ZX=0
2410 IFLEVZ>2ANDXX<3+LEVZANDXX>2ANDY
Z=5 THENPROCBLowCHECK2(3,6)
2420 IFXX>9-LEVZANDXX<10ANDYZ=5THENP
ROCBLOWCHECK1PLUS(11,6)
2430 IFXX>16-LEVZANDXX<17ANDYZ=23THE
NPROCBLowCHECK1PLUS(18,24)
2440 PROCDEL
2450 IFINKEY(-66)THENGOTO2310
2460 IFI=90THENYZ=YZ+1 ELSEENDPROC:I
FYZ>27THENYZ=27
2470 IFYZ>24THENYZ=24
2480 IFXX>0ANDXX<6ANDXX>3THENSZ=SZ-5
*LEVZ
2490 IFXX>14ANDXX<19THENSZ=SZ-5*LEVZ
2500 IFXX>8ANDXX<14ANDXX<24ANDXX>5TH
ENSZ=SZ+5*LEVZ
2510 SOUND1,-15,100,1
2520 PROCMOVECHECK1
2530 PRINTTAB(XX+2,YZ-1);CHR$32;VDU
10,10,10,8,127
2540 PRINTTAB(7,29);SZ;TAB(XX+2,YZ);
CHR$228;VDU10,8,229,10,8,238,10,8,8,
239
2550 ZX=0
2560 IFLEVZ>2ANDXX<3+LEVZANDXX>2ANDY

```



```

YZ=5 THENPROCBLowCHECK2(3,6)
2570 IFXX>9-LEVZANDXX<10ANDYZ=5THENP
ROCBLOWCHECK1PLUS(11,6)
2580 IFXX>16-LEVZANDXX<17ANDYZ=23THE
NPROCBLowCHECK1PLUS(18,24)
2590 PROCDEL
2600 IFINKEY(-98)THENGOTO2460
2610 ENDPROC
2620 DEFPROCMOVER2
2630 I$=INKEY$(0):I=ASC(I$)
2640 IFI=136THENXX=XX-1 ELSEGOTO2740
2650 IFXX>2ANDXX<9ANDXX<6THENSZ=SZ-5
*LEVZ
2660 IFXX>9ANDXX<16ANDXX>22THENSZ=SZ
-5*LEVZ
2670 SOUND1,-15,100,1
2680 PROCMOVECHECK2
2690 PRINTTAB(XX+1,YZ);CHR$32;VDU10
,127,10,9,127,10,9,9,127
2700 PRINTTAB(7,29);SZ;TAB(XX,YZ);CH
R$228;VDU10,8,229,10,8,230,10,231
2710 ZX=0
2720 PROCDEL
2730 IFINKEY(-26)THENGOTO2640
2740 IFI=137THENXX=XX+1 ELSEGOTO2850
2750 IFYZ>17ANDYZ<25ANDYZ>16THENXX=1
6:ENDPROC
2760 IFXX>3ANDXX<10ANDXX<6THENSZ=SZ+
5*LEVZ
2770 IFXX>10ANDXX<17ANDXX>22THENSZ=S
Z+5*LEVZ
2780 SOUND1,-15,100,1
2790 PROCMOVECHECK2
2800 PRINTTAB(XX-1,YZ);CHR$32;VDU10
,127,10,9,127,10,9,9,127
2810 PRINTTAB(7,29);SZ;TAB(XX,YZ);CH
R$228;VDU10,8,229,10,8,230,10,231
2820 ZX=0
2830 PROCDEL

```

Escape the Goulogs listing

From Page 185

```

2840 IFINKEY(-122)THENGOTO2740
2850 IF1=6STHENY%Y%-1 ELSEGOTO3000
2860 IFY%<1THENY%=1
2870 IFX%>0ANDX%<6ANDY%>4THENS%SZ+5
*LEV%
2880 IFX%>14ANDX%<19ANDY%<23ANDY%>1T
HENS%SZ+5*LEV%
2890 IFX%>7ANDX%<14ANDY%>2ANDY%<24TH
ENS%SZ-5*LEV%
2900 SOUND1,-15,100,1
2910 PROCMOVECHECK2
2920 PRINTTAB(X%,Y%+3);CHR#32;VDU10
,32
2930 PRINTTAB(7,29);S%;TAB(X%,Y%);CH
R#228;VDU10,8,229,10,8,230,10,231
2940 Z%=0
2950 IFX%>9-LEV%ANDX%<10ANDY%=5THENP
ROCBLOWCHECK1(11,6)
2960 IFX%>16-LEV%ANDX%<17ANDY%=23THE
NPROCLOWCHECK1(18,24)
2970 IFLEV%>2ANDX%<3+LEV%ANDX%>2ANDY
%=5THENPROCLOWCHECK2PLUS(3,6)
2980 PROCDEL
2990 IFINKEY(-66)THENGOTO2850
3000 IF1=90THENY%Y%+1 ELSEENDPROC
3010 IFX%>8ANDX%<14ANDY%>5ANDY%<24TH
ENS%SZ+5*LEV%
3020 IFX%>0ANDX%<6ANDY%>3THENS%SZ-5
*LEV%
3030 IFX%>14ANDX%<19THENS%SZ-5*LEV%
3040 SOUND1,-15,100,1
3050 PROCMOVECHECK2
3060 PRINTTAB(X%,Y%-1);CHR#32;VDU10
,10,10,32
3070 PRINTTAB(7,29);S%;TAB(X%,Y%);CH
R#228;VDU10,8,229,10,8,230,10,231
3080 Z%=0
3090 IFX%>16-LEV%ANDX%<17ANDY%=23THE
NPROCLOWCHECK1(18,24)
3100 IFLEV%>2ANDX%<3+LEV%ANDX%>2ANDY
%=5THENPROCLOWCHECK2PLUS(3,6)
3110 IFX%>9-LEV%ANDX%<10ANDY%=5THENP
ROCBLOWCHECK1(11,6)
3120 PROCDEL
3130 IFINKEY(-98)THENGOTO3000
3140 ENDPROC
3150 DEFPROCDEL
3160 FORA=0TO200-66*(LEV%-1):NEXT
3170 ENDPROC
3180 DEFPROCSTART
3190 PRINTTAB(1,29);"SCORE=" ;TA
B(7,29);S%;TAB(1,30);"LEVEL=" ;TA
B(7,30);LEV%;TAB(13,29);CHR#32;VDU32
,32,32,32,10,127,127,127,127,127,1
27
3200 IFLIV%=0THENPROCEND
3210 FORV=0TOLIV%-1:PRINTTAB(13+V,29
);CHR#240;VDU10,8,241:NEXTV
3220 REPEAT:UNTILGET=32:Z%=0:X%=2:Y%
=23
3230 TIME=0
3240 PROCCLIVES
3250 ENDPROC
3260 DEFPROCINST
3270 LEV%=0
3280 PRINT"*****DO YOU WANT INSTRU
CTIONS?"
3290 IF GET#(">Y"THENGOTO3390
3300 PRINT" The aim of the game is
to guide the""balloon round the cou
rse and score a""goal by arriving at
the far end. You""can choose your l
evel(1-4) or have""a progressive inc
rease in level(5)"
3310 PRINT"every time you score a go
al. A bonus""is scored depending on
your speed,""and you gain an extra l
ife for""each goal scored."
3320 PRINT" The balloon MUST be kept
moving.""If it is left in the same
place for""too long, it will burst.
If the""balloon or the string touch
the""sides of the course it will als
o""burst."
3330 PRINT" Press the 'SPACE' bar to
re-start""play at each level and af
ter bursting""a balloon."
3340 PRINT""PRESS 'SPACE' TO CONTI
NUE"
3350 REPEAT:UNTILGET=32
3360 CLS
3370 PRINT""'A'-----moves the ba
lloon UP""'Z'-----moves the ballo
on DOWN""'CHR#219;""-----moves t
he balloon LEFT""'CHR#221;""-----
-moves the balloon RIGHT""'PRE
SS 'SPACE TO CONTINUE"
3380 REPEAT:UNTILGET=32
3390 CLS:INPUT""*****"CHOOSE YO
UR LEVEL""(1-4,PROGRESSIVE=5)"M%
3400 IFM%>5THENM%=5
3410 IFM%<5THENLEV%=M%
3420 IFM%=5THENLEV%=1
3430 ENDPROC
3440 DEFPROCEND
3450 IFM%=1ANDHI1%<S%THENHI1%=S%:PRO
CFANFARE:COLOUR2
3460 IFM%=2ANDHI2%<S%THENHI2%=S%:PRO
CFANFARE:COLOUR2
3470 IFM%=3ANDHI3%<S%THENHI3%=S%:PRO
CFANFARE:COLOUR2
3480 IFM%=4ANDHI4%<S%THENHI4%=S%:PRO
CFANFARE:COLOUR2
3490 IFM%=5ANDHI5%<S%THENHI5%=S%:PRO
CFANFARE:COLOUR2
3500 FORD=0TO5000:NEXT
3510 CLS:PRINT""YOUR SCORE=";S%;
3520 COLOUR1:PRINT""HI-SCORES""Le
vell.....";HI1%;""Level2.....";HI
I2%;""Level3.....";HI3%;""Level4.
.....";HI4%;""Prog.....";HI5%;
""Do you want""another game?""PRE
SS'Y'"
3530 REPEAT:UNTIL GET=89:GOTO90
3540 ENDPROC
3550 DEFPROCLOWCHECK1PLUS(J%,K%)
3560 LOCALP,Q
3570 P=RND(10):Q=RND(4)
3580 IFP>4+LEV%THENENDPROC
3590 PROCLOW1(J%,K%)
3600 FORB%=0TO4
3610 FORF=0TO200-33*(LEV%-1):NEXT
3620 PROCBAL1
3630 PROCSTR1
3640 NEXTB%
3650 ENDPROC
3660 DEFPROCLOWCHECK2PLUS(J%,K%)
3670 LOCALP,Q
3680 P=RND(10):Q=RND(4)
3690 IFP>4+LEV% THENENDPROC
3700 PROCLOW2(J%,K%)
3710 FORB%=4TO0 STEP-1
3720 FORF=0TO200-33*(LEV%-1):NEXT
3730 PROCBAL2
3740 PROCSTR2
3750 NEXTB%
3760 ENDPROC
3770 DEFPROCLOWCHECK1(J%,K%)
3780 LOCALP,Q
3790 P=RND(10):Q=RND(4)
3800 IFP>4+LEV% THENENDPROC
3810 PROCLOW1(J%,K%)
3820 ENDPROC
3830 DEFPROCLOWCHECK2(J%,K%)
3840 LOCALP,Q
3850 P=RND(10):Q=RND(4)
3860 IFP>4+LEV% THENENDPROC
3870 PROCLOW2(J%,K%)
3880 ENDPROC
3890 DEFPROCFANFARE
3900 LOCALX,Y
3910 RESTORE3940
3920 FORN=1TO20:READX,Y
3930 SOUND2,-15,X,Y:NEXT:ENDPROC
3940 DATA53,5,69,5,81,6,89,3,81,5,69
,5,53,5,69,5,81,6,89,3,81,5,69,5,53,5
,69,5,81,15,89,15,73,6,69,3,73,5,61,1
0
3950 ENDPROC

```

This listing is included in this month's cassette tape offer. See order form on Page 217.

SLIMLINE PRECISION

These superbly engineered slimline disc drives for the BBC Microcomputer are unsurpassed in quality and accuracy. They feature direct drive brushless D.C. motors and long-life ceramic read/write heads for maximum reliability, and a die cast alloy chassis which gives rigidity and long term stability. Furthermore, advanced chip technology, using large scale integration permits extremely low power consumption to be achieved.

The Pace range includes drives which are switchable between 40 and 80 tracks. Double sided drives give a massive 400K storage per drive in 80 track mode, whilst in 40 track mode they retain compatibility with all commercially available BBC software. All Pace drives will support double density operation.

PACE disc drives are supplied complete and ready to run direct from the BBC's power supply. They are supplied complete with all cables, a utilities disc, and manual. Pace even supply a blank disc so that the drive is ready for immediate use!

Available from your local dealer or direct from:

PACE
Disc Systems

92 NEW CROSS STREET,
BRADFORD BD5 8BS
Tel. (0274) 729306
Telex 51564



CONTACT YOUR
NEAREST DEALER
FOR VERY
SPECIAL PRICES

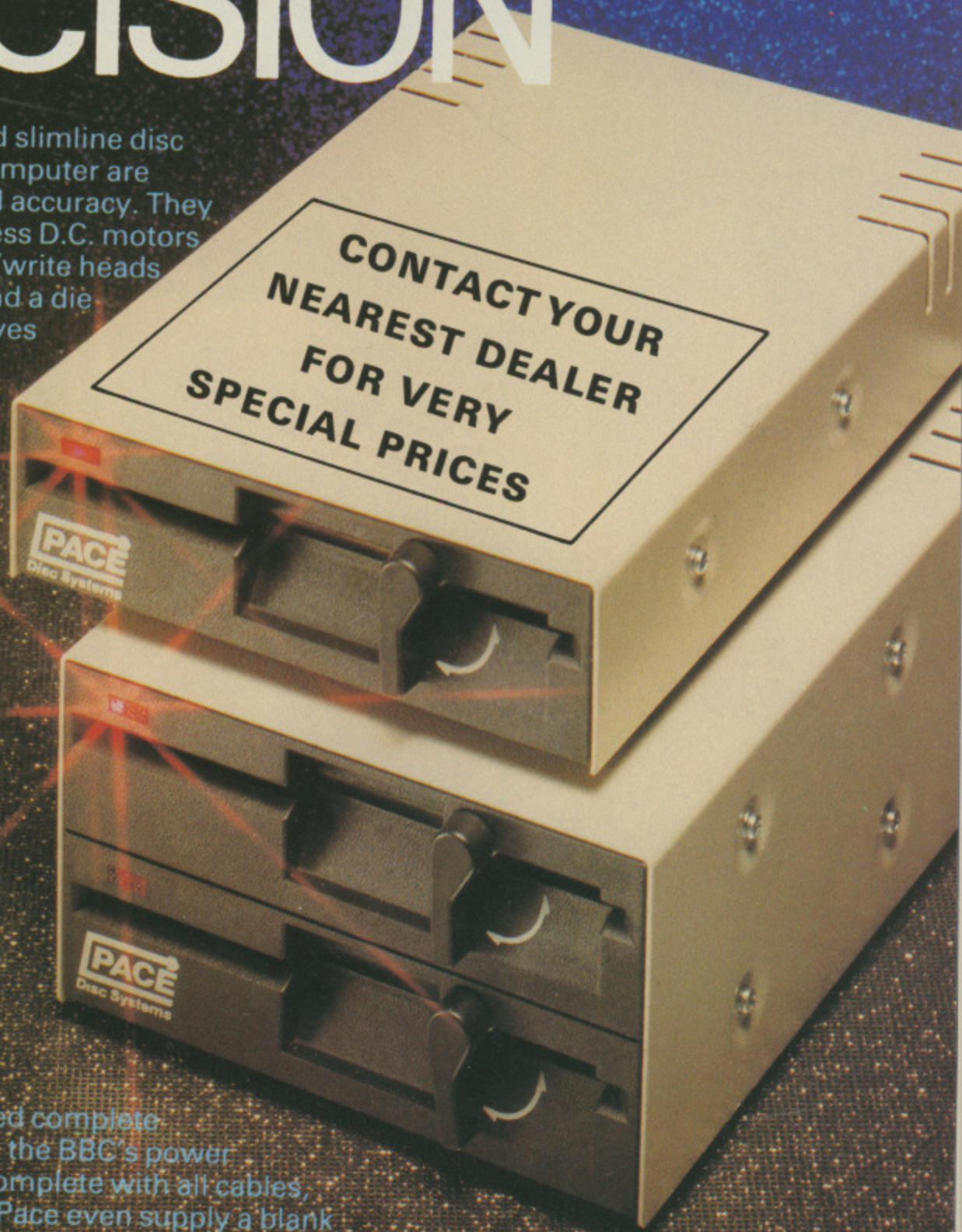

Disc drives available:-

SINGLE DRIVES

PSD1	Single Sided 40 Track	100k
PSD2	Double Sided 40 Track	200k
PSD3	Double Sided 40/80 Track	400k
PSD4	Double Sided 80 Track Only	400k
PSD5	Single Sided 40/80 Track	200k

DUAL DRIVES

PDD1	Single Sided 40 Track	200k
PDD2	Double Sided 40 Track	400k
PDD3	Double Sided 40/80 Track	800k
PDD4	Double Sided 80 Track Only	800k
PDD5	Single Sided 40/80 Track	400k

Available from good Computer stores everywhere including:
Computer City, Widnes, Cheshire. Tel. 051-420-333. Computerama, Stafford. Tel. 0785-41899. Computerama, Stoke-on-Trent. Tel. 0782-268620.
Silicon Centre, Edinburgh. Tel. 031-557-4546. G.T.M. Leeds. Tel. 0532-647474. Wadding Computer Centre, Wigan. Tel. 0942-44382.
National Micro Centre, Stockport. Tel. 061-486-4523. Sir Computers, Cardiff. Tel. 0222-21341. Eltec Computers, Bradford. Tel. 0274-722512.

QUALITY NEVER LOOKED SO GOOD—

Now everyone with a BBC or IBM PC will want to get their paws on CUB's sleek new D series plastic cabinet — a triumph of ergonomics and up to the minute design. Within it is the CUB 653 MEDIUM RESOLUTION colour monitor — the perfect mate for computer users who wish to combine the advantages of brilliant, low cost colour graphics with 80 column processing software.

CUB 653's remarkable depth of colour is enhanced by minimal screen glare, thanks to a super high contrast CRT. Even in well lit environments the 653 (H) x 585 (V) resolution and 0.43mm dot pitch produces 80 column text which is pin-sharp and easy to read. Owners of SHARP, RML 480Z, APPLE Series, WANG and other leading computers needn't feel left out, because CUB 653's compatibility extends to these models and many more.



PICK ONE UP FOR JUST £299 inc. VAT

NEW LOW PRICE, NEW PLASTIC CABINET — THERE'S NEVER BEEN A BETTER TIME TO BUY.

Standard Resolution version also available in new cabinet. Both Standard and Medium resolution models produced in metal cabinets if required.

MICROVITEC 653 CUB COLOUR DISPLAYS

Microvitec PLC, Futures Way, Bolling Road, Bradford, BD4 7TU, West York
Tel: (0274) 390011 Telex: 517717



Available from High Street Computer Retailers and selected branches of W. H. Smith, Harrods, John Lewis Partnership, John Menzies with selected models available from larger branches of Boots

Increase your fire power!

More than just a joystick—a system

- ▲ Nylon encased—Steel shafted joystick with ball and socket joint.
- ▲ Fast sprung return to centre.
- ▲ Graphite wiper linear potentiometers.
- ▲ 12 Months Guarantee.
- ▲ 7 day Money back Guarantee (on Hardware).

Complete control at your fingertips

A superb joystick and a keypad for the price of either one. Plus the software to integrate it into the computer's system. One handset will work on it's own in the A/D port as a joystick and two fire buttons. Joystick is immediately compatible with ACORNSOFT and similar software.

The interface joins together the analogue and the user ports to use the full keypads giving a total of 24 user definable keys. The interface can also be used as a splitter for the A/D port to take two items at the same time, e.g. joystick and lightpen.

DELTA DRIVER on cassette or disc: Two programs on each cassette or disc. One converts machine code programs from the keyboard to the joystick or keypad, with adjustable sensitivity on the joystick and will run on any O.S. The second program (needs O.S. 1.0 or later and an interface) duplicates any keyboard keys on the keypads, in the operating system, so that it can become a numeric keypad or will take on the function keys.



Numerous stockists nationwide or direct from us.

SAE for more detailed information.



Made in England

DELTA 14b HANDSET £14.95
DELTA 14b/1 A/D/USER PORT INTERFACE £14.85
DELTA DRIVER CASSETTE £5.95 or DISC £9.95
Prices include VAT and P&P.

Voltmace delta 14b

VOLTMACE LTD
PARK DRIVE
BALDOCK
HERTS
SG7 6EV
Tel: (0462) 894410



Callers welcome at the factory—Monday to Friday.

MD 400
£155.65
+ VAT = £179

MD 800
£312.17
+ VAT = £359

MD 800P
£373.04
+ VAT = £422

BBC Compatible Mitsubishi Slimline Disc Drives

These are high capacity, precision drives with dynamic clamping and very low power consumption. All drives are supplied with cables, a very comprehensive utility/format disc and a manual.

MD 400 — 400K (800K double density) 40/80 track switchable double sided single drive.

MD 800 — 800K (1600K double density) independently 40/80 track switchable double sided dual drive.

MD 800P — 800K (1600K double density) independently 40/80 track switchable double sided dual drive unit with built-in power supply and monitor stand.

Opening Hours: Mon-Fri 9am-6.30pm
Sat 10am-5pm (ample parking)
We accept telephone orders on Barclay
and Access Cards.

Mail Order: Cheques or bankers draft
payable to Akhter Instruments.
Delivery free of charge (UK only)



COMPUTER GROUP

28/29 BURNT MILL, HARLOW, ESSEX CM20 2HU UK.
TEL: HARLOW (0279) 443521 TELEX 818894 AKHTER G

Dealer Enquiries
Welcome

UK's LOWEST PRINTER PRICES !

PRINTERLAND



ORDERED TODAY - DELIVERED TOMORROW

DOT-MATRIX

EPSON RX 80	£189.95
EPSON RX 80 F/T	£219.00
EPSON RX100	£329.00
EPSON FX 80	£317.00
EPSON FX100	£425.00

DOT MATRIX PLUS NEAR-LETTER QUALITY

CANON PW1080A	£249.00
---------------	---------

DAISY-WHEEL

JUKI 6100	£325.00
EPSON DX100	£356.00

ACCESSORIES

WORDWISE	£32.00
PAPER (2000 Sheets)	£12.00
BBC/PRINTER CABLE	£10.95

COPYALL DISK

- Copies ALL protected disks inc. tape to disk utilities.
- Best on the market
- Copies from original to your blank disk **£10.25**

Educational, G'ment plus O'seas Orders Welcome
Please add 15% VAT. Delivery Printers £10.00. Paper £3.00. Other 50p
Printerland, Unit 27, Estate Buildings, Railway St., Huddersfield HD1 1JP

TEL (0484) 514105

Adventure into

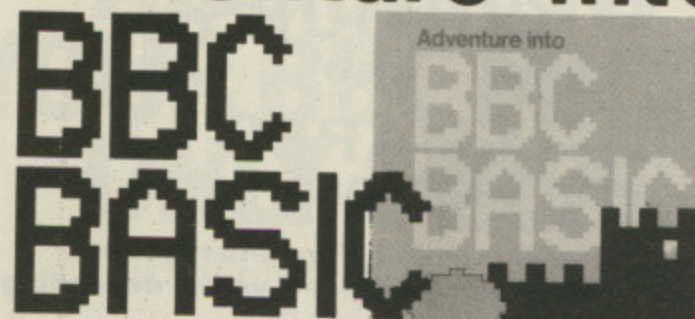

by **Miles ELLIS**
Computing Services
University of Sheffield
and
David ELLIS

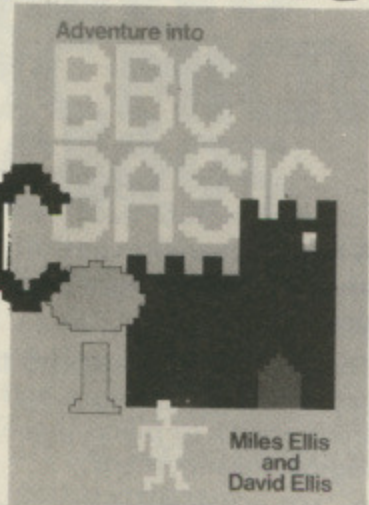

A book with a difference! This is far more than a conventional teach yourself programming book. By using a sophisticated and exciting adventure game Miles Ellis, with the aid of his twelve-year old son, has designed a program which will be enjoyable from the outset as well as teaching the beginner the basic principles of good programming style, the use of sound effects, colour, graphics, program editing, and the storage and reloading of tapes.

With its innovative approach this book is outstanding because it has dared to turn the basic concept of teach yourself books on its head. In this way it captures and retains the interest and overcomes the frustration of so many would-be programmers.

An accompanying cassette tape and disc of the Adventure Game are also available for the BBC Microcomputer Model B.

CONTENTS

- What's it all about? ● Some basic principles ● Sounding off ● Using the right procedures ● Seeing is believing ● Variety is the spice of life ● Communication is the name of the game ● Adding it all up ● Some characters to play with ● A bit more flexibility ● Improve your graphics ● Get animated ● Another way of expressing yourself ● Dealing with sets of data ● Saving your results ● More advanced sound ● Some other useful features of BBC Basic ● Appendices ● Index

0471 90171 7	Book 336 pages	(paper) £6.95
0471 90531 3	Book and Cassette	£12.95
0471 90530 5	Book and Disc	£14.95

MODULAR MICROCOMPUTER CONSOLES FOR SCHOOLS, HOMES AND OFFICES

Just 2 examples of our extensive range of consoles. This system is easily adapted to suit your personal requirement and can be readily expanded upon. The consoles support your TV/monitor safely above your micro and provide safe storage for disk drive/s, cassette recorder, books etc. The sturdy, well designed, mild steel construction also enables your micro to be stored safely underneath when not in use.

All consoles are formed with double bends to provide a completely safe edge to the front and rear whilst the bottom edge has rubber trim for safe use on desks etc. Attractive textured finish in either black or BBC colour match. Whilst these consoles are designed for the BBC micro they lend themselves perfectly to a variety of other models.

Write or phone for full colour brochure including dimensions and price list.



From £19.75 + VAT

TRADE, EDUCATIONAL ENQUIRIES WELCOME, DISCOUNTS AVAILABLE

J & W BUNCE

Thorpe Industrial Estate, Unit 3, Crabtree Road,
Thorpe, Egham, Surrey TW20 8RN.
Egham (0784) 33555

ORDER FORM to:

Annabella Duckit, John Wiley & Sons Ltd., FREEPOST,
Baffins Lane, CHICHESTER, West Sussex PO19 1YP
Tel: Chichester (0243) 784531 Telex: 86290 (Reg. No. 641132 England)
Please send me: **Adventure into BBC BASIC**

....0471 90171 7	Book	£6.95
....0471 90531 3	Book and Cassette	£12.95
....0471 90530 5	Book and Disc	£14.95

- I enclose cheque for made payable to John Wiley & Sons Ltd.
- Please charge my AMERICAN EXPRESS/DINERS CLUB/ BARCLAYCARD/VISA/ACCESS

Card No.

Date of Expiry

Telephone your credit card order —
dial 100 and ask for FREEFONE 3477 (UK only)

Name

Address

Signature

*** NEW! ***
**COLOURS
 AND
 SHAPES**
 BBC MODEL B

A logic extension activity for primary school children in the age range 3-8 years, depending on ability.

The program is designed to aid children in the recognition of colours and shapes, and to develop their ability to place these colours and shapes in a logical arrangement.

Q: What has this program got to offer?

- A:** It is currently in use in schools.
A: It was developed in conjunction with teachers.
A: The program has been written to professional standards.
A: Five levels of difficulty - adults select appropriate level.
A: Database of shapes used - different game each time.
A: Sound and music.
A: Comprehensive instructions with cassette.

Send your cheque or postal order for **£5.75** to the address below. All prices include postage, packing and VAT.

A1 BUSINESS COMPUTING LIMITED
 9 Columbia Close, Selston, Notts. NG16 6GP.
 Tel: 0773 860443

"S" OO PER CAL ER FR ADGE EL IST IC EX P EE AL EE D DH SH US"

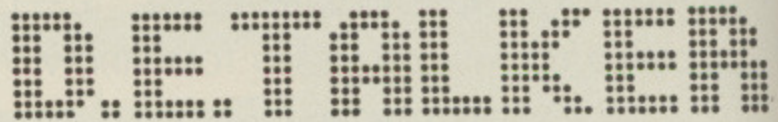

Speech Synthesizer

FOR BBC MODEL B

Close Approximation of Text to Speech
Immediate Verbal Acknowledgement on "power up"

Unlimited Vocabulary

Word Representation to Sound

User Programmes Easily Modified by using a Simple *S Command

FITS INTO ONE OF THE BBC ROM SOCKETS

Price £41.00 inc. P&P complete
including Simple Fitting Instructions and User Guide

Please make all Cheques and Postal Orders to:

D. E. SYSTEMS

44 Cross Street, Widnes, Cheshire WA8 6LT



ADD 40 COMMANDS TO BBC BASIC WITH ONE ROM

**G
R
A
P
H
I
C
S**

SCALE is a powerful and totally flexible statement that allows the user to take control of the scaling of the screen. Integers, real numbers and variables can be used.

ROTATE is used to 'rotate' the axes about a point and by an angle both defined by the ROTATE statement on a scaled screen.

CIRCLE and **ELLIPSE** allow a multitude of shapes to be drawn using a single statement, including:- any regular polygon, circles, arcs, solid sectors, triangles, squares, etc.

FILL is used to 'fill' a previously drawn area, with CFILL setting the colour/pattern/shade within pre-drawn bounds.

TRANS is used to translate the scaled area across the screen by the use of cartesian co-ordinates, subsequent graphics commands making use of the now displaced scaled area.

Plus: SMOVE, SDRAW, SPLOT and UNSCALE.

**4
I
N
1**

LLIST can be programmed, unlike LIST, and under the user's control, multiple statement lines can be split up into their component parts allowing for greater ease of reading.

LGOTO is similar to the GOTO statement but more powerful in that it enables the user to jump to 'labelled lines' allowing for neater and more readable programmes.

SORT allows the user to sort all or part of a string array into alphabetical order using single statement. Invaluable for data processing.

SETWIN and **WIN** allows the user to define, using SETWIN, and display, using WIN up to seven complete windows on the screen. The user being able to select and return to previously de-selected windows at will, the cursor maintaining its last used position within that window.

Plus: OPT, POPFOR, POPGOS, POPREP and ADDCOMM

**G
E
N
E
R
A
L**

Compatible with: Acorn DFS,
 Amcom(Pace) DFS, Watford DFS,
 Wordwise, Disc Doctor.
 Model B, BASIC 1 or 2, OS 1.20

ADDCOMM

Plus: *HELP displays the full syntax of all commands. Price includes a detailed ring-bound User Guide.

Now available for Electron with Rom board

**L
O
G
O**

LMOVE is used to position the LOGO cursor, usually used prior to further LOGO statements.

ANGLE is used to set the intended direction of the LOGO cursor, the angle being described in degrees.

ADVANCE is used to move the cursor in the direction as set by ANGLE by the distance described in the ADVANCE statement.

TURN gives the cursor a new direction by turning it a certain number of degrees anti-clockwise from its previous direction.

PEN defines the kind of trail left by the LOGO turtle using the internal plot codes.

LCIRCLE and **LELLIPSE** are the LOGO equivalents of the similar enhanced graphics commands, the shape centre being the current LOGO cursor position.

LPOS is used to return the position of the LOGO cursor from a SCALED screen.

£28

includes
 VAT
 post and
 packing

CHAR is a simplified 'character' designing facility using an enlarged grid that enables the user to quickly and easily construct or alter graphic and pseudo-alphanumeric characters.

COMPACT is used to reduce the size of all or part of an existing program by intelligently appending lines together.

FIND is used to search all or part of a program to find any desired character or set of characters.

GREPL and **SREPL** are two related commands that enable the user to replace a character or group of characters with any other character or group of characters, under total control of user.

LVAR is used to list all, or alphabetically selected, variable names currently within memory.

VERIFY is a simple command to confirm that a copy to tape or disc is exactly the same as the original program in memory.

Plus: MEM, GOODPROG, KILLREM and FKEYS.

**T
O
O
L
K
I
T**

Available now from:

**VINE MICROS, MARSHBOROUGH,
 SANDWICH, KENT. CT13 0PG.**

(Or send stamp for Brochure.)



The Original "NEWARK" TV/RGB Monitor

It's a 14" remote control Grundig TV!!

ORIC
ATMOS

(BBC/Acorn)
(MSX)

(Electron)

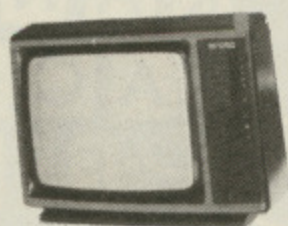

It's an RGB computer monitor

It's £249.94 inc VAT - complete Package!!

It resolves 80 characters!!

QL (Almost)

The Package:

£249.94 for a remote control 14" TV with a computer lead - delivered to your door - including VAT

(We even fit a mains plug!) and carriage

We have a LARGE range of GRUNDIG models from 14" to 26" with or without Teletext.

Contact Elaine for an up to date leaflet package

NEWARK VIDEO CENTRE LTD

108 London Rd, Balderton, Newark, Notts.
Tel: 0636 71475 to order by Access or Visa. Mon-Sat/9am-6pm

ADD 32K TO YOUR BBC MICRO ONLY £49.95.

Opus Supplies offer you Rambank - a 32K sideways RAM board to really boost the capabilities of your Micro.

Unlike ROMs, each block is individually write selectable and can be write protected to ensure against accidental erasure.

If you're running short of ROM sockets, the RAM card allows you to load utilities as and when they are needed.

We'll give you software and utilities free of charge, so you can save ROM based firmware on disc.

- Uses low power 64K dynamic RAM chips.
- Simple to install.
- Consists of 2 x 16K blocks of sideways RAM.
- 2 year guarantee.

Opus.

Opus Supplies Ltd.

158 Camberwell Road, London SE5 0EE. 01-701 8668 or 01-703 6155.

INTRODUCTION TO THE STARS**FOR ALL AGES

NEW FROM "SMALL SCHOOL SOFTWARE"
SUPERB 'STUDY PACK' OF THE CONSTELLATIONS AND STARS OF THE NORTHERN SKY.



- * Sophisticated menu driven suite of six programmes
- * Special programmes teach recognition of constellations
- * Enter date, time and use cursor keys to explore night sky
- * Comprehensive manual with colour foldout star map
- * Special integrated disc version available
- * BBC and ELECTRON

Cassette version
£9.95
5 1/2" disc version
£11.95



SMALL SCHOOL SOFTWARE,
Mail Order Department (M),
14, Saltmarsh Lane,
HAYLING ISLAND,
Hampshire PO11 0JT.

Break the BBC sound barrier!

Add the power of ROM based software to your micro!

EXPERIENCE A GREAT NEW DIMENSION IN MICRO SOUND!

The National Micro Centres hi-fi adapter allows you to bypass the BBC Micro's internal speaker and feed the sound signal into your own hi-fi or music centre.

- Easy to install - no soldering
- Three-position switch allows use of internal or external speaker - or turns off sound completely
- Full instructions supplied
- Fully isolated unit
- Much more than an additional speaker - allows full use of your amplifier's controls

Turn your micro into a word processor, a disassembler, a multi-language machine, or a communications terminal - at the flick of a switch!

Once there was a physical limit to the number of ROMs you could use. But with our ROM extension socket you can now gain access to an infinite number of ROMs quickly - and safely.

- Zero-force insertion socket protects valuable eeproms from damage
- Easy to install - no soldering
- Fits into the ashtray for easy access - no need to meddle with the micro's innards
- Full, simple to follow instructions supplied

Hi-fi adapter ONLY **£19.95** inc. VAT Carriage free

ROM extension socket ONLY **£22.95** inc. VAT Carriage free

Please supply _____ Hi-fi adapter(s) at £19.95 each inc. VAT

Please supply _____ ROM extension sockets at £22.95 each inc. VAT

I enclose a cheque/PO No. _____ for £ _____ made payable to: National Micro Centres

Please charge my credit card No. _____

Signed _____

Name _____

Address _____

National Micro Centres
36 St. Petersgate
Stockport SK1 1HL
Tel: 061 429 8000

POST TO: NMC, 36 St. Petersgate, Stockport SK1 1HL

EPROM PROGRAMMER

FOR THE BBC

A very high quality product direct from the manufacturers, contained in attractive sloping box with low insertion force socket and neon indicator for programming fitted as standard, the software adopts the high efficiency method for programming 2764 and 27128. This allows up to 100% faster programming, software in machine code, supplied on cassette and can be placed in eeprom. Very easy to use, menu driven with easy to use instructions. This unit is completely self contained with its own power supply and plugs into the user port.

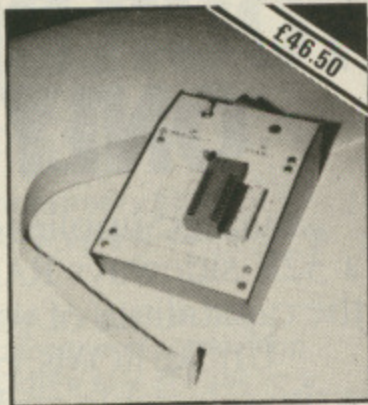

THIS PROFESSIONAL UNIT ALLOWS:

1. Will program: 2716, 2732, 2532, 2764 and 27128 eeproms.
2. Copy eeprom into memory and compute checksum.
3. Blank check eeprom.
4. Program eeprom from memory.
5. Verify byte by byte and compute checksum.
6. allow buffer start area to be changed.
7. All operating system calls may be used when in menu mode.
8. Semi-intelligent programming. Typical time to program a 2764 8k device is approx. 50 sec. depending on the data to be programmed.
9. Additional software supplied to enable your own program (basic or machine code) to be put into eeprom with the necessary leader information to allow calling with a *command. Downshift routine to enable basic programs to be run is also supplied.

COST £46.50 please add 15% VAT £1.00 post and package

Also available: RAM/ROM card 16 socket - details on request.

ORDERS TO:

H.C.R. ELECTRONICS, Industrial Unit,
Parker Road, Chelmsford, Essex CM2 0ES.

Access Orders Phone:

Chelmsford (0245) 350188 24 hours



an INTRODUCTION to

RANDOM
ACCESS
FILING

on the
BBC MICRO

This 120 page book is supplied with a FREE floppy disc containing TWO demonstration systems - a STOCKFILE SYSTEM and a PERSONNEL SYSTEM

IF YOU WANT

- to use your disc drives as something more than just fast cassettes.
- to be able to store and retrieve data instantly.
- to learn how to create your own systems.
- to understand how Filing Systems can work.
- to join the vast numbers of people worldwide who have benefited from this package.

**THEN YOU CAN BUY THE BOOK FOR
£12.50 COMPLETE FROM:**

The Computer Room 206 Main Street
Newthorpe Nottingham 0773 718578

EXTENDED (by H&B)
UNTIL 30th SEPTEMBER
(while stocks last)

SPECIAL SUMMER OFFERS!!

SAVE £80.00

**BBC MODEL B
CASSETTE PLAYER
5 ACORNSOFT TITLES**

£399 inc VAT

SAVE £50.00

DISC DRIVE AND INTERFACE FOR £229.95

(Acorn Disc Interface with 100K 40 track Disc Drive)

*Mail/telephone orders to Oldham address * £1,000 instant credit available * Carriage £4.25 per machine, UK mainland * Access/Barclaycard welcome * Prices correct at time of going to press E & O E

Home & Business Computers

THE NORTH'S LEADING COMPUTER SUPPLIERS

54 Yorkshire Street
Oldham
Tel: 061-633 1608

73 Yorkshire Street
Rochdale
Tel: (Rochdale) 344654

59 Daisy Hill
Dewsbury
Tel: 0924 455300

MUSICSOFT

MUSIC SPECIALISTS FOR THE 32K BBC MICRO

★ THE SYNTH ★ (O.S. 1.0+)

"A very flexible and inventive program that's highly recommendable." (Dr David Ellis, E&MM, Oct 83). This 'synthesizer' program has features which to our knowledge are unique. ALTER RHYTHM. The rhythm of a recorded melody may be altered by tapping on a single key. REPEAT. No need to play a phrase twice, great saving in space. REAL TIME PLAYING. With alteration of volume, envelope and octave pitch as you play a note. EDITING. Back and forwards whilst hearing the tune. INPUT. May be hesitant or in correct time. TIDY. 'Cleans up' inaccuracies of input on demand! NUMBER OF NOTES. From 3000 for 1 channel to 1000 for 3, etc. Plus all the other synthesizer programs do PLUS, IE sophisticated envelope editing (very easy), larger keyboard used (TAB to ↓ cursor). No secrets, user transparent. This is the program for the experimenter who wants to make HUMAN music rather than perform mathematical finger dexterity exercises. THE SYNTH. Cassette & instructions only £8.75 inc. P&P.

★ KEYBOARDS ★ (O.S. 1.0+)

5 programs to turn your BBC into 5 real-time keyboards. 1. 3 simultaneous voices (in Basic for easy understanding) 2. Single voice M/C with Pitch Bend. 3. 3 simultaneous voice M/C with Envelope control built in. 4. Single finger Chord organ ranging over the whole keyboard, 2 variations for each chord. 5. Chord organ 2 with different chord configuration. These are all separate programs designed for you to use as they are or in your own programs.

KEYBOARDS cassette & instructions £5.75 inc P&P

★ MUSICTOOLS ★ (all O.S.)

"Musicsoft also produce an excellent 'Musictools 1' cassette... all in all, rather good value" (E&MM, Oct 83)

Five music utility programs on one tape.

Tune Generator with dynamic graphic Keyboard & Stave display, Envelope Command Explorer (Very easy to use), Musical Symbols Graphic routine, Simple single line organ with sophisticated controls. Over 60 procedures for you to use in your programs already in working programs.

MUSICTOOLS 1 cassette & instructions £5.75 inc. P&P.

★ PIEMAN ★ (all O.S.)

"The best version of Simon I've seen, it goes so much further than most" (Quote by a rival software firm!) Recommended for Primary & Middle Schools. Not as simple as Simon! It develops into a fun set of ear cleaning and musical concentration games.

PIEMAN cassette & instructions £5.75 inc. P&P.

ACORN APPROVED

ALL PROGRAMS TRANSFER EASILY TO DISC.

Cheques and official orders to:

MUSICSOFT, 12 Fallowfield, Amptill, Beds.

Telephone: 0525 402701

All 4 programs £24 - on 40 track disc £25.00

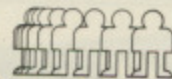

MICROMAN Computers

ACORN SPECIALIST COMPUTER CENTRE



ACORN/BBC COMPUTERS:

Acorn Electron	199.00
BBC Model B	399.00
BBC Model B + DFS	469.00
Acorn Teletext Receiver	225.00
Acorn 6502 2nd Processor	199.00
Acorn Z80 2nd Processor	299.00
Acorn IEEE Interface	325.00
Bitstick	375.00
Electron Plus I Interface	59.90

BBC UPGRADES:

A-B Upgrade (Fitted)	95.00
DFS Interface (Fitted)	109.00
Speech Synthesizer (Fitted)	55.00

PRINTERS:

Epson RX80FT	295.00
Epson FX100	574.95
Star Gemini 10X	268.00
Star Delta 10	385.00
Cannon PW-1080A	330.00
Shinwa CP80	220.00
Sanple Daisywheel Printer	332.35

TORCH COMPUTERS:

Z80 Disc Pack	799.00
Z80 2nd Processor Card	339.00

BBC FIRMWARE:

View ROM	59.80
Wordwise ROM	44.85
Viewsheet ROM	59.80
B-Base Database Disc	25.00
Ultracalc Spreadsheet ROM	74.75
Computer Concepts from	33.35
Toolstar ROM	34.00
Commstar EPROM	34.00
BCPL ROM	99.65
Sidewise ROM	44.70
Solidisk 32K Sideways RAM	57.95
Solidisk 96K Extension	92.00
Solidisk 128K Sideways RAM	149.95

MODEMS:

Grapevine/Commstar Modem	P.O.A.
--------------------------	--------

MONITORS:

Decca RGB Standard	228.85
Microvitec Cub Standard	228.85
Zenith Green	109.25
Decca TV/Monitor	265.00

DISC DRIVES:

Full range available	POA
----------------------	-----

WE OFFER A FULL RANGE OF SOLIDISK SIDEWAYS RAM PRODUCTS INC. A SOLIDISK FITTING SERVICE

WE HAVE A RANGE OF BUSINESS & WORD PROCESSING PACKAGES BASED AROUND THE BBC & TORCH COMPUTERS

ACORN APPROVED SERVICE CENTRE
Our workshop offers a comprehensive service including Repairs and Upgrades by our own engineers

EDUCATIONAL & INDUSTRIAL ENQUIRIES WELCOME



All prices include VAT, Post & Packing £9 (Large items) £1 (Small items ROM's etc)

RAINFORD INDUSTRIAL ESTATE, MILL LANE, RAINFORD, ST. HELENS, MERSEYSIDE

PHONE 074488 5242



ROM/RAM EXPANSION system for the BBC Micro

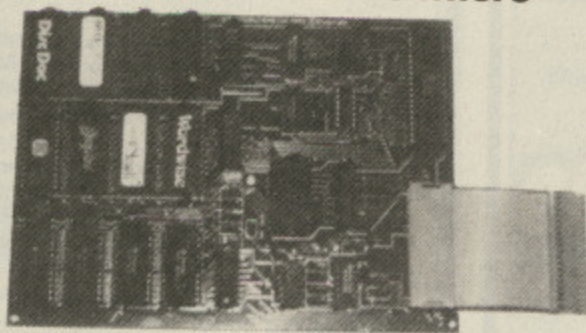

The Ultimate ROM/RAM Board For The BBC Microcomputer!

- ★ Provides twelve extra ROM sockets, allowing up to sixteen ROMs to be used simultaneously.
- ★ All sockets are fully buffered.
- ★ Four of these sockets may be reconfigured to accept static RAM (16K maximum).
- ★ Automatic switching allows ROM software to be *LOADed into sideways RAM directly from tape or disc.
- ★ Original software may be assembled directly into sideways RAM.
- ★ Accepts either 6116 or 6264 RAM chips.
- ★ The board will accept 2K, 4K, 8K and 16K chips.
- ★ Fully compatible with Acorn 6502 and Z-80 second processors, Torch Z-80, 8088 (Graduate) and 68000 (Unicorn) second processors and most double-density disc interfaces.
- ★ No soldering or track cutting necessary. The board plugs directly into the computer's processor socket via a short flexible connector.
- ★ The board is held firmly in place by sturdy plastic supports - no stress is placed on any vital components or sockets.
- ★ Comprehensive operating manual provided.

£54.95

All our prices are inclusive of VAT unless specified otherwise Postage & Packaging: Please add £1 for small items (ROM/RAM Boards, Software, etc), £2.50 for medium items (Disc drives, BBC Computers), £10 for heavy items (Printers, monitors, etc). (Postal rates apply within UK only. Please telephone for export rates) Access/Barclaycard Telephone orders welcome

SIR COMPUTERS LTD

91 Whitchurch Road, Cardiff CF4 3JP.

Tel: Cardiff (0222) 621813

SIR BUSINESS & COMMUNICATIONS

We announce our appointment as TORCH UNICORN Dealers, at a time when Acorn & TORCH are joining forces...

THE TORCH UNICORN RANGE:

CP/M compatible extensions to the BBC Microcomputer System:

ZEP 100: Z80 2nd processor card; 64K RAM; FREE SOFTWARE (see below) £299 + VAT.

ZDP 240: Z80 Disc Pack comprising ZEP 100; 2x400K floppy disc drive; FREE SOFTWARE (see below) £799.00 inc. VAT.

HDP 240: As ZDP 240 but with one 400K drive replaced by a 20MB Winchester Hard Disc unit... around £1,995 + VAT.

HDP 68K: As HDP 240 but with twin (Z80B and 68000) "second" processors; provides an extra 256k RAM!... around £2,495 + VAT.

THE UNICORN: Top of the range. The TORCH UNICORN comprises HDP 68k plus FULL UNIX III Operating System... around £2,895 + VAT.

TORCH C-500: Complete self-contained unit (no BBC Micro required) comprising BBC Micro system, ZDP, hi-res colour monitor & British Telecom-approved communication card. Price available on application.

FREE SOFTWARE: BBCBASIC (Z80) [allowing almost 48K User Memory!]; 'Perfect' Writer (word processor); 'Perfect' Calc (spreadsheet); 'Perfect' Filer (database filing system); Complete software package normally worth about £1,000!!

BBC MICROCOMPUTER	
BBC Model A	£289.00
BBC Model B	£379.00
BBC Model BD	£469.00

MONITORS	
Sanyo B/G	£85.00
Microvitec RGB	£219.00

DISC DRIVES	
Single 100k	NOW £139.00
Dual 100k	NOW £279.00
Dual 400k (40/80 Track Switchable)	NOW £399.00

SOFTWARE
We have a range of BBC and Electron titles currently in stock including ROM based programs such as

VIEW (£59.80), New 2.1 version Computer Concepts' GRAPHICS ROM (£32.20), WORDWISE (£39.95) and DISC DOCTOR (£29.95).

PRINTERS	
Dot Matrix:	
Shinwa CP-80	£219.00
Epson RX-80 F/T	£275.00
Epson FX-80	£389.00
Daisywheel:	
Juki 6100	£389.00

Please telephone for full details of software range and current stock.

ACORN BBC SECOND PROCESSORS	
6502 2nd Processor	£199.00
Z80 2nd Processor	£299.00

GAMES?

Playing them is easy but can you write your own?

Me and My Micro

Will show you how to use loops, print things on screen, move them about and control their movement from the keyboard.

Follow the ideas in this book

and construct your own game programs that are exciting, efficient and easy to debug.

£2.95 including p&p
from Bookshops or direct from NEC

NATIONAL EXTENSION COLLEGE
18 Brooklands Avenue
Cambridge CB2 2HN

See the 'Me and My Micro' TV series

HORNBY SOFTWARE

Britain's top
Spectrum Pro-Golf Series
now available for the first
time on BBC
Model B 1.2 O.S.



The real thing, exact simulation of Britain's top golf courses.

1. All golf rules apply.
2. Designed for one or two players.
3. Played off any handicap.
4. On each hole, distance, par, green enlargement.
5. Control shot - choice of all clubs, strength, direction.
6. Graphics excellent.
7. Extremely realistic.

TROON £7.75 NEWBIRKDALE £7.75
WENTWORTH EAST & WEST COURSE £11.00
Latest Programme
MOORTOWN SCENE OF FIRST INTERNATIONAL
1984 £7.75
ALSO SPECIAL OFFER
FULL SERIES £28

All prices include VAT & P&P

Available from:

HORNBY SOFTWARE
21 Pinfold Hill, Leeds LS15 0PW.
Telephone: 0937 65847

EDUCATIONAL SOFTWARE BBC Micro B

M-JS

FRACTIONS

Tutorial cassettes with an unlimited number of exercises.

Introduction	£6.95
Addition	£7.95
Subtraction	£7.95
<i>And available in September</i>	
Multiplication	£7.95
Division	£7.95

Text is based on the notes of a junior school head

TOPICS In English for 6-9 year olds

Multiple choice programs designed to improve vocabulary, spelling, word power and comprehension, each program has 5 topics of 10 exercises.

Topics 1 and 2 **£6.95** Topics 3 and 4 **£6.95**

Text prepared by a junior school teacher

QUIZ

A competitive general knowledge game for individuals or teams.

Quiz 1 **£6.95**

TOWERS OF HANOI

Learn and develop logical skills in an attractive game. It can be set to suit all ages.

Towers of Hanoi **£6.95**

MICRO-NINERS

Develop word power and solve clues with an intriguing word game

Micro-Niners **£6.95**

Prices include post and packing, please send cash with order or write or phone for further details to:

MICRO-JENN SOFTWARE LTD
81 Squirrels Heath Road, Harold Wood Essex RM3 0LR
Telephone: Ingrebourne (04023) 42801

Private Viewdata C-FAX

C-FAX is a package for setting up and displaying private TELETEXT information on a BBC Model B Computer (OS 1.2) Typical uses include advertising displays, electronic newspapers and notice boards, and specialised databases.

Up to 390 Teletext (Mode 7) pages can be stored on one disc and instantly recalled by the display program, which simulates the standard broadcast CEEFAX operation - including time/date and current page number display.

The software consists of the display program (on disc) and a ROM based editor which can be called up at any time to make changes or additions. In addition to the usual Mode 7 editor facilities, it is possible to copy or move any block of characters, insert or delete characters on a line, write in LARGE text, and use comprehensive Graphics routines.

C-FAX has the familiar features of broadcast Teletext and also supports Demonstration routines, Menu pages, Page chaining with variable display time, Animation, Musical tones, Programmed learning, and the counting of all pages requested.

The package includes a specially designed handset which connects to the BBC via the user port. A disc containing example pages is also supplied.

Package Price £99.00
Package without KEYPAD £45.00

(Please state 40 or 80 Track Disc)

The Keypad can also be supplied separately for £60.00 including software to redefine the keys to operate with your programs.

The above prices include VAT and P&P (UK)
Send Cheque/P.O. to:

MICROFAX LTD.
19 Grasmere Ave. Blackburn, Lancs. BB1 8LD



wildings

COMPUTER CENTRE

EPSON PRINTERS

RX80 £239.95

RX80F/T £269.95

FX80 £375.00

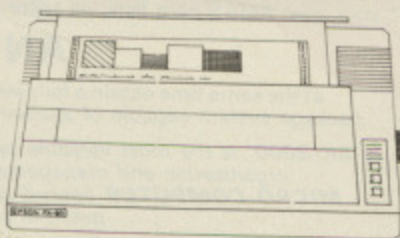

The superb range of Epson printers are even better value than ever at these super new low prices.

SHINWA CP80

- * 80 column and self test
- * Friction and tractor feed
- * Bi directional printing
- * Hi res graphics
- * Many more features

WILDINGS
LOW PRICE **£229.95**

COSMOS 80

Limited quantities of this printer are available at the amazing low price of

**** £199.95 ****

Specification is the same as the Shinwa.

PACE DISK DRIVES

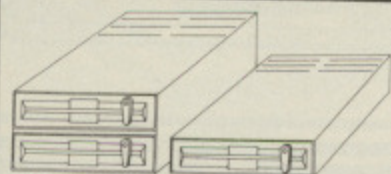

The extensive range of Pace disk drives are fully compatible with the double density op. systems which are now becoming available.

With Wildings super low prices and a drive to suit every purpose you need look no further.

PSD1 (100K single) 40T	£169.95	PDD1 (200K double) 40T	£334.95
PSD2 (200K single) 40T	£239.95	PDD2 (400K double) 40T	£469.95
PSD3 (400K single) 40/80T	£279.95	PDD3 (800K double) 40/80T	£555.95
PSD4 (400K single) 80T	£244.95	PDD4 (800K double) 80T	£479.95
PSD5 (200K single) 40/80T	£254.95	PDD5 (400K double) 40/80T	£499.95

All drives include formatting disk and manual.

Various disk operating systems in stock. Please phone or call for details.

MONITORS

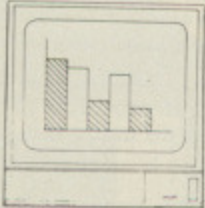
MICROVITEC	SANYO	CD3125N
14" Cub colour monitor inc. VAT £219.95		14" colour monitor inc. leads for connection to the BBC Micro. Few only at £199.95
14" Cub colour monitor with sound facility inc. VAT £239.95		

MAIL ORDER Please address all postal and telephone enquiries to the Wigan branch.

Postage - Monitors, Drives, Printers - £5.00. Prices inc. VAT.

PRICES CORRECT AT TIME OF GOING TO PRESS BUT SUBJECT TO CHANGE WITHOUT NOTICE E & O E

WIGAN

11 Mesnes St, Wigan
Lancs. WN1 1QP
Tel: Wigan (0942) 44382
Closed Wed.

BOLTON

23 Deansgate, Bolton
Gr. Manchester BL1 1HH
Tel: (0204) 33512
Closed Wed.

CHORLEY

68 Market St, Chorley
Lancs. PR7 2SE
Tel: Chorley (02572) 74224
Closed Wed.

PRESTON

49 Fishergate, Preston
Lancs. PR1 8BH
Tel: Preston (0772) 556250
Closed Thurs.

WARRINGTON

111 Bridge St, Warrington
Cheshire WA1 2AR
Tel: (0925) 38290
Closed Thurs.

STOCKPORT

1 Little Underbank, Stockport
Cheshire SK1 1LA
Tel: 061-480 3435
Closed Thurs.

COMING SOON

Two autumn specials from

THE MICRO USER

Games Galore!

An Aladdin's cave of really outstanding programs that will delight every BBC Micro enthusiast. It contains 12 great games - all original and all fully listed. Arcade games, card games, strategy games and sports simulations - they're all there.

PLUS a unique A to Z guide to all the games software currently available for the BBC micro. Something you will want to keep and refer to again and again in the months to come.

On sale October 26. Price £1.95.

Classroom Computing

Packed with practical programs which teachers can use in the classroom and parents can use to teach children at home. Mathematics, language, shape recognition, coordinates, drawing, geometry are just some of the subjects covered by programs that will fascinate children of all ages, from early learners to secondary pupils.

PLUS the most detailed guide available to all the educational software that has been provided for the BBC Micro. All programs are alphabetically listed and described.

On sale September 28. Price £1.95.

Place an order now
with your newsagent!

HIGH QUALITY CASSETTE-BASED
SOFTWARE FOR THE BBC
MICROCOMPUTER (32K).

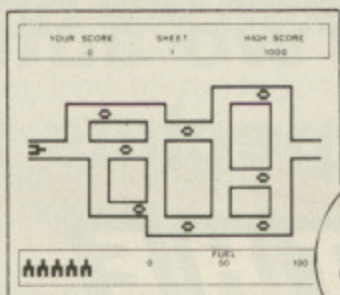

NIGHTMARE MATHS

Get through the space-maze solving maths problems on the way, but watch out for the comets, laserbolts and meteors. High score table and extra 'sheets' for the successful. Three levels of difficulty, with graded hazards too. Age 10 upwards.

PICTURE

Use this package to create new characters and combine them in high resolution pictures. Characters and pictures can be saved and used in your own programs. Sample character sets and pictures included.

THE ESTABLISHMENT AND SHIPWRECKED

A two program package of simple text adventures, featuring fantasy environments. An ideal stimulus for creating writing and art.

Available from:-
LOGICAL EDUCATIONAL SOFTWARE,
12, Rowditch Avenue,
Derby, DE3 3LD

(Please add 60 pence P + P to order total).

£7.50

£7.50

£7.50

EDUCATIONAL

**INTRODUCTORY PRICES FOR
BEEB USERS
NO EXTRA FOR UK VAT OR POSTAGE!**

MENU DISC Make all your discs menu driven. Sort out your files at last with this disc which enables files to be run at the touch of a single key. Simplicity itself to create/amend/delete the menu of your choice. Ideal when inexperienced operators or young children need to use the computer. May be copied for your own use with all your own discs.

MENU DISC (state 40 or 80 track) **£8.00**

USER PORT INTERFACE BOARD Interface and control or monitor external circuits for hobby, home security, process control etc. Invaluable as a software development aid since LEDs indicate the status of all 8 I/O lines and both control lines. DIL switches can simulate all inputs and invert all outputs. Separate terminal blocks for input and output logic connections and BEEB's own 5V supply. Optional relays can be fitted to each of the 8 output lines.

USER PORT INTERFACE BOARD **£29.00**
INTERCONNECTING CABLE (to user port) **£8.00**
OPTIONAL RELAY (fitted) **£2.00**

KEYBOARD COVER Rigid moulded cover fits only over the keyboard and speaker sections, so may be used easily when the computer is installed with only the keyboard area accessible. Protects against dust and accidental damage.

KEYBOARD COVER **£7.00**

COMPUTER COVER Superior fitted black leatherette cover to protect your computer, available either plain or personalised with your own name or initials.

COMPUTER COVER (plain) **£5.50**
PERSONALISING (per letter) 50p

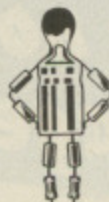

ELECTROLINK LTD

FREEPOST, Church Crookham
Aldershot Hants, GU13 0BR
Tel: 02514 4332 or 0252 543095
Order now, or ask for our free data sheet

IF

you don't want to use your **BBC MICRO-COMPUTER** for listing ADDRESSES, learning ALGEBRA, looking up your APPOINTMENTS, preparing simple BALANCE SHEETS, playing your own one-armed BANDIT, checking your BANK BALANCE, working-out the real costs of your CAR, creating your own DATA-BASES, just DOODLING, checking the date on your CALENDAR, CATALOGUING lists of whatever you like, looking-up and writing entries in your DIARY, playing GAMES, testing your GENERAL KNOWLEDGE, casting your own and friends' HOROSCOPES, enjoying colourful screen INTERLUDES, leaving MESSAGES for your family and friends, estimating MILEAGES between major cities, practising calculating amounts of MONEY, learning your MULTIPLICATION TABLES, playing NOUGHTS AND CROSSES, writing-out and looking-up your favourite RECIPES, seeing how your SAVINGS will grow, playing SNAP, doing SUMS, writing your personal TELEPHONE DIRECTORY, telling the TIME from an elegant Sun-clock, displaying your TIME-TABLE, testing your knowledge of WORD meanings, or writing your own XMAS card lists, all tailor-made for your own machine

AND

at the same time obtain a fully integrated '**SK-2000**' program package system capable of accommodating all your own programs ('**SK-2000**' is the most versatile system of computer programming, organisation and management available for the **BBC MICRO-COMPUTER** backed-up by advisory, information and patch-in services)

THEN

don't send a cheque for only £50 to:

MILL SOFT
'HUMFORD MILL'
BEDLINGTON
NORTHUMBERLAND
NE22 5RT

for the most comprehensive suite of fully structured programs ever written for the **BBC MICRO COMPUTER**

ELSE

buy over thirty odd programs instead for a total cost of around £500

REM

TAPE (please state Model 'A' or 'B') · DISC (please state format)

ephagy Software
Products
Present

Disc-Minder Service: We offer to protect disc based BBC computer software to make it inaccessible to disc sector editors and back-up/copying utility programs. Write now for further information.

Copyrite: Disc Back-up Utility

WARNING This powerful package is not intended to be used to break copyright. It is capable of duplicating most protected disc based software and as such must be used with discretion.

Copyrite and other products protected by Disc-Minder cannot be recreated using this program.

(Disc) Price **£10.95**

Flexibase: A direct access data base and report generator - suitable for use in Education, data collection, personal records etc. Write for full specification.

(Disc) Price **£14.95**

Texprint: True mode 7 dump utility. Includes instructions to merge with a teletext editor.

(Disc) Price **£8.95**

Games: (Cassette only) Education: (Cassette/disc)

Fruity Fruity (Cass) Primary English Pack (Disc) £10.95
£6.95 (Missing words, Word jumble) (Cass) £9.95

Stuka (Cass) Primary Activity Pack (Disc) £10.95
£6.95 (Music writer, Picture Draw) (Cass) £9.95

Ephagy Software Products
Rear of 125, Corporation Road,
Grimsby South Humberside DN31 1UR

mw systems

SUMMER SPECIAL OFFERS



ONLY
£330

MWS 800K (1.6MB) at Double Density.
DUAL DRIVES from TOSHIBA.
These drives are double sided/double density and are 40/80 Track Switchable.



ONLY
£200

MWS 400K (800K at Double Density).
SINGLE DRIVE from TOSHIBA.
These drives are also double sided/double density and are 40/80 Track Switchable.

mw systems ltd.

Matrix House
Lincoln Road
Cressex Industrial Est.
High Wycombe
Bucks
Tel (0494) 450341

ORDER FORM

All prices are exclusive of VAT.
Price includes Formatting Disc,
Manual and all Cables.
All units carry a one year warranty.
All units are ex stock.

Please supply the following Order

	Quantity	£	p
MWS 800K DUAL DRIVES Summer special offer price £330.00			
MWS 400K SINGLE DRIVE Summer special offer price £200.00			
MWS 200K SINGLE DRIVE Summer special offer price £140.00			
MWS 100K SINGLE DRIVE (not illustrated) Summer special offer price £135.00			
MWS Optional Power Supply £35.00			
Please debit my Access/Barclaycard/Amex/Diners	Delivery	£10.00	
	Sub Total		
Card No. <input type="text"/>	VAT 15%		
I enclose a cheque for £..... made payable to MW Systems	TOTAL		



ONLY
£140

MWS 200K.
A SINGLE DRIVE from EPSON.
These drives are double sided/single density and are 40 Track.

Name _____

Address _____

Tel No. _____

Don't play Blindman's Bluff.



Imaging A program that takes pictures for printing, storage and transmission. A second version of the program can be used to record a short animation sequence.

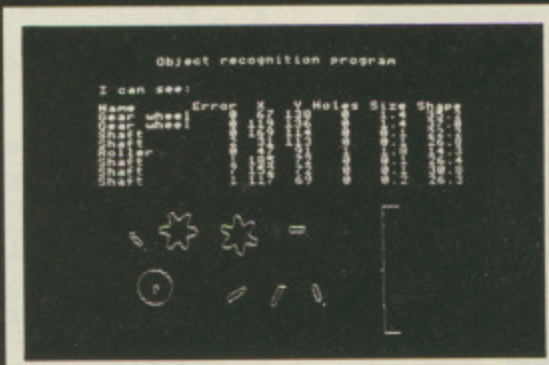

Object recognition A powerful program for analysing a scene containing multiple non-overlapping parts. Area, perimeter, centre of gravity, are calculated in a split second.

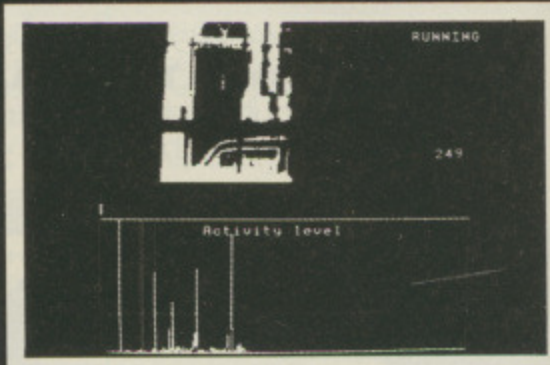

Movement detection A program that analyses any movement in a scene which for example could be used to count the number of people moving down a street or ring an alarm if anything moves.

There's no need to keep your home computer in the dark a minute longer. The Micro-Robotics EV1 is a revolutionary new electronic camera that can be connected to your computer to give it the power of sight. It has applications in the fields of security, in industrial object recognition, graphic design, robotics and Artificial Intelligence. For the first time it is possible to capture black-and-white and grey scale pictures on a microcomputer without the use of an expensive external video camera. Full documentation and a comprehensive library of useful software are provided with each system, all for **only £129.95** (inc. VAT).

Dealer enquiries welcome.

Technical Specification
Resolution 246 x 128 Size 70 x 50 x 55 mm
Capture Time 64mSec Interface Userport
Weight 75 grms



Please send to:- Commotion, 241 Green Street, Enfield, EN3 7SJ. Tel: 804 1378.
Please send me:- Software on tape (BBC Model B) Software on 80 track disc (BBC Model B)
 Software on 40 track disc (BBC Model B)

Qty	Item	Ex VAT	Inc VAT	TOTAL
	EV1 Complete	£113.00	£129.95	
	Software on disc	£1.74	£2.00	
Postage and Packaging				£1.25
TOTAL				£

I enclose my cheque/P.O. for £
I prefer to pay by Barclaycard, Access Card (Please delete as necessary).

Card No _____
Signature _____
Name _____ Address _____
Address _____
(Address above must be same as cardholder.)

HOW
ground
Mode 7
the equ
for Mo

I'm s
answer
where.

Kent.
● To
ground
the CH
you w
(CHR
line w
The lat
first C
ground

The
print
positio
so that
line by
tedious
Alte
the re
screen

10
20
STEP
NEXT
30

Lin
any sc
memo
The
&7CC
down

AFT
the s
mand
from
1983
comm
terest
Th
was e
a Ba
opera
Basic
"LIN

MICROMAIL

HOW can you fill the background with any one colour in Mode 7? In other words, what is the equivalent of the following for Mode 7:

```
10 MODE2
20 GCOLOR,129:CLG
```

I'm sure there must be an easy answer, but I can't find it anywhere. — M. Wyatt, Gravesend, Kent.

● To fill a line with one background colour, you simply place the CHR\$ number of the colour you want in the left hand byte (CHR\$131 for yellow) of the line with CHR\$ 157 next to it. The latter tells the micro that the first CHR\$ refers to the background colour.

The easiest way to do this is to print them in the correct positions with Tab using a loop so that the whole screen is filled line by line. This can be a bit tedious though.

Alternatively you can poke the required bytes onto the screen, as in this listing:

```
10 CLS
20 FOR LX=&7C00 TO &7FFF
STEP 40: ?LX=&131:LX?=&157:
NEXT LX
30 A$=BET$
```

Line 10 is necessary to avoid any scrolling affecting the screen memory locations adversely. The screen then starts at &7C00, and the step 40 moves it down line by line.

Background to that Mode 7 colour scene

The varying values of L% ensure that the code for yellow is poked down the left of the screen, and that for background next to it.

This of course is the unforgivable crime against Acorn — directly addressing the screen. So it won't work over the tube!

You must remember that the two leftmost characters of each line are being used. Sticking another character on top of either will undo your hard work.

That's why we used line 30 to stop the prompt sign appearing at the top of the screen and spoiling my first line. Leave it out and see!

Monitor bug hunt

I WAS interested to read the letter by P. Stanesby in your July issue about the Break "bug" in the Monitor listing.

Like your correspondent I spent considerable time typing both the listing for the Monitor and also the "toolkit".

Unfortunately I could get

neither of these to work satisfactorily and in sheer desperation sent for the tape only to find that the problems which I had encountered were still present.

In the case of the "toolkit" I still have a peculiar fault in that although formatting is effective for any number of tracks, the catalogue listing of the formatted blank always shows option (9) with (9) in colour and sometimes flashing.

The Monitor program is much more troublesome. Like your correspondent, I found that the S, T and R commands caused a return to Basic, and changing the entry points to those in your correspondent's letter provided only a partial solution.

With these, I cannot get the Z function to operate. Step and trace commands work after a fashion.

I might add that the Monitor disassembles correctly and the M and L commands are satisfactory although with long listings occasional returns to menu occur.

Perhaps you may be able to

offer some advice. The set up which I have is Basic II with O.S. 1.2 and DFS .98? — F.W. Adams, Sheffield.

● You are correct in saying the trace command will not work when tracing through ROM. However, all of the other commands have been tested and all work correctly.

One source of error could be the misprint in the letter by P. Stanesby. This should have read:

'Change JMP&8AE1 to JMP&8B38', not just JSR as printed.

I hope this is useful.

Wordwise safeguard

I HAVE tried Marcus Adams' program to safeguard accidental overwriting of files, which appeared in the July edition of the Micro User, on my BBC Model B.

This program works a treat but it was a disappointment to me that it did not work with Wordwise. Is there any way to adapt it to do so?

When using Wordwise it is very easy to lose a document when loading. For example, if key f1 is pressed instead of key f2 a blank document is saved which is then given the file name of the document one was attempting to load.

The result is the complete loss of the document.

A protect utility would be invaluable here. — R.G. Loveday, Woking, Surrey.

● Your wish is our command. We'll be publishing a utility to help you out with your problems in the near future.

Taking the wrong line

AFTER my last letter to you on the subject of the LINE command you sent me an extract from your magazine of August 1983. This covers the *LINE command, and I read it with interest at the time of publication.

The LINE command that I was enquiring about, however, is a Basic command and not an operating system one, that is a Basic token which is listable as "LINE".

The token has value &86 and is given in the User Guide on page 484 in the section on minimum abbreviations.

Insertion of this token into Basic text does list as "LINE" but the use of the command in various syntax forms standard to both BBC and Microsoft Basic return a variety of errors, primarily "Mistake" and "Syntax error".

Since this is obviously a Basic

command or standard variable — like COUNT, TOP etc — and not documented in any other section of the manual, could you please shed some light on its uses, if any. — T.C. Thomas, Guildford, Surrey.

● Sorry, we should have known our readers better than that. The LINE you're referring to is the latter half of Basic's INPUT LINE.

Shapes on show

THE following addition to Teditor (August issue of The Micro User) causes the micro to display all the graphic shapes in turn with the appropriate keyboard symbol.

The routine is called by pressing the Esc key and then G (Graphic) as a command, when the full block (255) is displayed on the bottom line of the screen.

Pressing < or > causes the graphic character number to be increased or decreased and the appropriate shape and character displayed, so it is very easy to search for an appropriate shape.

Pressing the space bar returns to the main program.

Amend the printed program as follows. Where possible I have made the amendment the first item of any line.

```
920 PRINT "Command (G,L,S
,C,I,D,W,B,E,M,?)";
930 G%=INST("GgEeSsLl?/Bb
CcWwIiDdMm", GET$):G%=(G%+1
)DIV 2
950 ON G% GOTO 955,1080,9
60,970,980,990,1000,1010,10
20,1030,1040 ELSE 920
955 PROCclear:PROCgraphlet:
GOTO1050
1685 PRINT "G..Graphic Sea
rch"
```

Add the following PROC:

```
2500 DEFPROCgraphlet
2510 GL=255
2520 PRINTTAB(3,24)*Graphi
c ";CHR$(1 51);CHR$(6L)
;CHR$(135); " = ";CHR$(G
L);
2530 g=GET:IF g=60 OR g=44
THEN GL=GL-1:IF GL=223 THE
N GL=191 ELSE IF GL=160 THE
N GL=255
2540 IF g=62 OR g=46 THEN
GL=GL+1:IF GL=256 THEN GL=
161 ELSE IF GL=192 THEN GL=
224
2550 IF g=32 THEN g=255:EN
DPROC
2560 GOTO 2520
```

The line amendments and additions simply add the command G to the help page and the command line and direct it to PROCgraphlet.

In PROCgraphlet the graphic is first set to 255 and then displayed as a graphic and as the keyboard character in lines 2510 and 2520.

The next two lines add or subtract 1 from the character, but skip over the letters etc which have no equivalent graphic when < or > are pressed.

The last line returns to the main program when the space bar is pressed.

This has proved far more convenient than repeatedly looking

up the manual to find the necessary characters. — B.L. Hensman, Keighley, W. Yorks.

Beastie's forte

I THINK it important to clarify some points regarding "Beasty" and its use in films (August issue of The Micro User).

Servo motors are commonly used in special effects departments throughout the film industry for the control of the movement in robotic models.

Although the servos used could be controlled by the "Beasty" due to the complexity of the models, professional radio controlled equipment is used in its place.

The "Beasty" is more suited to the beginner in robotics who wishes to utilise computer control. — Timothy Coote, Commotion, Enfield.

Backgammon for two

CONGRATULATIONS on a great program — Backgammon (Micro User, July 1984).

There is just one thing missing, and that is an alternative for two players.

I'm sure many of your readers would appreciate an addition to the program.

How about it? — W.J. Russell, Maidstone, Kent.

● Can any of our talented readers rise to the challenge? Six to four on you do!

Doomrun mod

THANKS for the excellent magazine, particularly the July 1984 issue with the listing of "Doomrun" — a superb program.

May I offer a modification that may interest my fellow

readers — it adds a hi-score to the game.

It can be quite useful as your friend can't argue when you beat him!

Firstly, we must create some space for our extra lines, so delete lines 1750 to 1850 as PROCsp and PROC3sp appear identical.

Now change PROC3sp in lines 630 and 660 to PROCsp. That done, now add the following three lines:

```
90 R%=0
355 VDU20
365 IF H%>R% R%=H%:COLOUR
14:PRINTTAB(2,3)*NEW HI-SCOR
E= ";R% ELSE COLOUR14:PRIN
TTAB(4,3)*HI-SCORE= ";R%
```

I hope this will be of some use to my fellow readers. — N.D. Blount, Fallings Park, Wolverhampton.

Keyword tokens

HERE is a little tip which might prove interesting.

If a character with an Ascii value of more than &7F is entered into the keyboard buffer the computer recognises it as the token of a Basic keyword.

If the function keys are now defined to give values corresponding to these tokens "one touch" entry of keywords can be obtained.

The maximum number obtainable is 40 (f-keys, Shift + f keys, Ctrl + f-keys and Shift + Ctrl + f keys).

If the following Ascii file is created using *BUILD it can then be *EXECed when needed.

```
*BUILD KEYS
*FX 225,144
*FX 226,154
*FX 227,164
*FX 228,174
CLS
<Escape>
*EXEC KEYS
```

— S.P. Barker, Oberammergau, South Germany.

DEALING WITH DIGITS

IN "Scientific America" Fred Druenberger, Professor of Computer Science at California State University, writes an article on how to handle thousands of digits.

The example he takes is the square of the number 1.0000001 to the 134217728th power. He performed this calculation on several machines (not the Beeb).

The correct result to 10 significant figures is 674530.4707.

On his trials the Apple II Basic gave 22723.9709, an error

of 96.63114 per cent.

IBM PC Basic gave 8850273, an error of 1212.06425 per cent.

The TRS 80 machine gave 8886690, an error of 1217.4640 per cent. The BBC Basic gave an answer of — 685090.513, an error of 1.56553969 per cent.

What do we conclude about the rounding tactics used in BBC Basic? Not bad, eh? — J. Joyce, New Zealand.

● Want to write to Micromail? The address is: Micromail, The Micro User, Europa House, 68 Chester Road, Hazel Grove, Stockport SK7 5NY.

Friendly network

I AM writing to express my satisfaction with the excellent CAD network described in the March 1984 issue of The Micro User.

We have used this system for two months and found it to be both cheap to make and simple to use.

We have, however, found that since the system is frequently used by non-specialist staff, a more user-friendly version has been valuable.

I enclose a listing of this modified version as in use currently at the school. Should any of your readers have further suggestions for improvements or modifications, perhaps they would care to pass this on through these pages. — S. Randall, Mathematics Department, St Bedes RC High School, Lytham St Annes.

DFS mysteries

I HAVE spent many hours in hopeful anticipation typing in the "Dumper" program in the January 1984 issue of The Micro User "Printing Pixels" by A. Plume.

I would greatly appreciate a clear concise explanation of the steps required to assemble, save and run the above program on a BBC Model B with Acorn DFS.

In the numerous books I have bought on the BBC Micro, I have yet to see a clear concise explanation on the mysteries of the DFS and its use with assembly language programs.

In the above article, the length of the code is said to be 357 bytes, but when I type it in using PRINT TOP-PAGE, after only about six or seven lines (TOP-PAGE) >357. Please advise how 357 was obtained.

I believe there is a need for an article in the Micro User that clearly explains the steps of assembling, saving and running

```

1 REM CHEAPNET BY S.RAN
DALL
2 REM ORIGINAL IDEA BY
TONY CRAVEN (MICRO USER MAR
CH 1984)
100 *KEY0*FX3,7:ML.IMP.*
FX2,0:IM*FX3,4:IM
110 *KEY1*FX2,1:IM
120 *KEY30:IMRUN:IM
130 *KEY40:IM MODE6:IM VDU
19,0,4;0;IM VDU14:IM L. :IM V
DU15:IM
140 CLS
150 NF=0
160 PRINT:PRINT:PRINT:PRI
NT"STATION O.K"
170 PRINT"*****":PR
INT
180 PRINT:PRINT"f-key0 wi
ll transmit to filesaver"
190 PRINT"f-key1 will rec
eive from filesaver"

```

assembly language programs on disc, preferably illustrated with several examples.

The articles I have seen that contain assembly code have tended to be very brief in their explanation of where and how the code is saved etc.

I look forward to one day being able to use the above program on my Epson FX-80 printer. I hope that day is not too far away. — A.M. Lang, Zeeham, Tasmania.

● In your letter you say that TOP-PAGE is greater than 357, when you have only typed in several lines. The reason for this is that TOP-PAGE is the length of the Basic program, not the assembled code.

The length of the code can be found by typing PRINT P%-S%.

The Basic program and the assembled code are totally separate, therefore the length of each must be found using the two methods described above.

Lantern improved

AFTER typing in the lantern

```

200 PRINT"f-key3 will run
the current program"
210 PRINT"f-key4 will lis
t the current program"
220 IF NF=1 THEN GOTO 330
230 PRINT:PRINT"NOW TYPE
NEW AND PRESS <RETURN>":PRINT
240 *FX2,0
250 REM ABOVE LINES SENT
TO STATION
260 *KEY9*FX3,7:ML.100,25
0:MP."RUN":IM*FX3,0:IM
270 REM FILESERVER INSTRU
CTION DISPLAY
280 CLS
290 PRINT"NETWORK FILESER
VER O.K."
300 PRINT"*****
*****":PRINT
310 NF=1
320 GOTO 180
330 NF=0

```

program in the May 1984 issue of The Micro User, I found that a few alterations improve the effect.

Add line:

```
165 MOVEX-JX,IX
```

Change line 170 to:

```
170 PLOT85,XX-JX,IX
```

and alter line 140 to go down in steps of -3.

```
140 FORI=YZ+RZ TO YZ-RZ
STEP-3
```

The Micro User has been much improved by the new design of cover. It now lasts long enough without tearing till the next month's issue. — G. Abdullah, Tottenham, London.

Olympics timing

CONGRATULATIONS on your superb game Micro Olympics. I have played it often and have never succeeded in beating the computer at running (or at any of the other events).

I have a Microtest Starstick ROM and Quickshot 2 joystick

```

340 PRINT"f-key9 will set
up network at a station":P
RINT
350 PRINT"NEXT STEPS":PR
INT
360 PRINT"1) Select stati
on number at filesaver"
370 PRINT:PRINT"2) At tha
t station;"
380 PRINT"      a)Press
<BREAK>"
390 PRINT"      b)Type *
T. and press <RETURN>"
400 PRINT"      c)Type *
FX2,1 and press <RETURN>"
410 PRINT:PRINT"3) Back a
t the filesaver, press f9"
420 PRINT:PRINT"4) Select
next station, or if all se
t up, type NEW and press <R
ETURN>"
430 END

```

which has an auto fire option. Using this and the keyboard I have achieved a speed of over 60 mph. My achievements are listed below:

1. The 1500m in 41 seconds
2. The 800m in 25 seconds
3. The 400m in 10 seconds
4. The 200m in 6 seconds
5. The 100m in 3 seconds

Can anyone think of any other way to beat these times? — B. Sarosi, Abingdon, Oxon.

Records

FIRST of all I would like to thank you for such a good magazine and to thank you for such a great game as "Micro Olympics".

For many months, I have looked out for some records by Beeb owners, but so far there has not been any.

So here are a few of mine:

100m	8.90 secs*
200m	21.54 secs
Javelin	100.36m*
Discus	72.04m*
Hammer	84.82m*
High Jump	2.35m

* = World record. — S. Johnson, S. Yorks.

MICROMAIL

Interesting effects...

I WAS just fooling around with sines and cosines when I added a small VDU 19 routine onto the end and I got some interesting effects. So I have written out this listing:

```

10REM SPHERE
20MODE2
30VDU23;8202;0;0;0;
40VDU29,640;512;
50MOVE0,400
60FOR I=0 TO 360
70GCOLOR,I MOD15+1
80PLOT69,SIN(RAD(I))*400
,COS(RAD(I))*400
90PLOT69,SIN(RAD(I))*100
,COS(RAD(I))*400
100PLOT69,SIN(RAD(I))*400
,COS(RAD(I))*100
110NEXT
120FOR I= 0 TO 15
130VDU19,I,0,0,0,0
140NEXT
150REPEAT
160FOR I=1 TO 15
170*FX19
180VDU19,I,7,0,0,0
190TIME=0
200REPEATUNTILTIME=10
210VDU19,I,0,0,0,0
220NEXT
230UNTIL0

```

If this is typed in correctly there should be a sphere of multicoloured dots and after it has finished it should display a few small white dots rotating by themselves. — Miles Dymock, Stoke by Clare, Suffolk.

Coming clean

I WAS interested to read Cyril Flanagan's letter (June 1984) regarding the inclusion of inverted commas in PRINT and INPUT statements.

Some time ago I was faced with the problem and tried the

same method. However I soon got fed up with checking all the inverted commas to make sure I had the right number.

I wanted a better method that would get around statements like: PRINT CHR\$34; "Hello";CHR\$34;" he said."

After a bit of experimentation I found a simple 'clean' method. It only works in Mode 7 though, without re-defining characters.

In Mode 7 Ascii codes 161 thru 254, when enclosed by inverted commas, become "+128 wrap-round" versions of Ascii codes 33 thru 126.

It is a simple matter then to program one of the user definable keys to produce the Ascii code +128 of the character you wish to duplicate. In this case

it's Ascii code 162.

A better method probably would be to program the TAB key using *FX219. So far I haven't been able to do that and produce Ascii code 162. Most others, but not the one I want. Maybe someone else out there knows.

Anyway, for those that are interested, here it is:

```

OS 0.1.....*KEY0 H' "
<CR>
OS 1.0+.....*FX255,162
(or *FX226/7/8) <CR>

```

Then type in and RUN...

```

10 PRINT"+Hello, Fred+,
quoth he."

```

not forgetting to press user

definable key 0 where marked +.
— Jim Stretch, Bournemouth.

These are the jokes, folks!

I ALWAYS read you excellent Micro User. I think you should have a jokes section.

Here are some jokes:

Riddle: How did Mario get Killer Gorilla at the bottom of the screen?

Answer: Show him a banana.

What happens when you plug in a faulty Electron?

You get electricuted.

Please print this letter so the readers can send in jokes. If you

Helpful terminal software

MANY thanks for introducing the Microweb Bulletin Board and the very best of luck for the future with it.

I thought that readers who already own suitable modems might be interested in the terminal software that I have used successfully on other boards.

As you can see, after remov-

ing the explanatory lines from the listing, the necessary code for communicating takes up only half a dozen lines or so and is very simple to understand and operate.

As many readers will know, locations &FE08 and &FE09 monitor the RS423 port.

Perhaps in a future article

you might give some tips on downloading software. I'm afraid that I am a little baffled at present having failed twice to download into my Beeb's memory.

The printer option however, enabled me to take a listing of one of your first offerings. — Don Salt, Leicester.

```

10 REM TERMINAL SOFTWARE
20 REM FOR 300 BAUD BULL
ETIN BOARDS
30 REM INCLUDING 'MICROW
EB'
40 REM DISABLE FORM FEED
ON PRINTER
50 *FX6,12
60 REM DISABLE ESCAPE KE
Y
70 *FX220,0
80 REM SET BAUD RATES
90 *FX7,3
100 *FX8,3
110 ON ERROR VDU3:MODE7:E
ND
120 MODE7;VDU23;8202;0;0;
0;
130 PRINT'CHR$141 CHR$13
1" BBC MICRO TERMINAL "
140 PRINT CHR$141 CHR$131
" BBC MICRO TERMINAL "
150 PRINT''TAB(10)CHR$1
41 CHR$130*300 BAUD WORKING
"
160 PRINT TAB(10) CHR$141
CHR$130*300 BAUD WORKING"
170 PRINT''CHR$141 CHR$1
34" 1. Enable parallel pr
inter dump"
180 PRINT CHR$141 CHR$134
" 1. Enable parallel prin
ter dump"
190 PRINT
200 PRINT CHR$141 CHR$134
" 2. Disable printer"
210 PRINT CHR$141 CHR$134
" 2. Disable printer"
220 PRINT''TAB(8)CHR$14
1"Press appropriate key....
.."
230 PRINT TAB(8)CHR$141"P
ress appropriate key....."
240 REPEAT:choiceZ=SET:UN
TIL choiceZ=49 OR choiceZ=5
0
250 IF choiceZ=49 THEN CL
S:PRINTTAB(5) "DIAL NOW":VD
U2:ELSE CLS:PRINTTAB(5)"DIA
L NOW"
260 wait = INKEY(1500):CL
S:REM delay during dialling
270 VDU23;10;0;0;0;:REM s
teady block cursor
280 REM NOW FOR THE MAIN
LOOP
290 REM THAT ALLOWS US TO
COMMUNICATE
300 REPEAT
310 IF (?&FE08 AND 1) =
1 PRINTCHR$ (?&FE09 AND 12
7);
320 a$=inkey$(0):IF a$(>" ?FE09=ASCa$
330 UNTIL0

```

do not like my idea, please please, please print my listing.

The computer will ask you a number. Do that and press Return. Then the computer will ask you another number. You cannot enter a number bigger than 6. Well, bye from one of your greatest readers. — R. Jugon, Wembley, Middlesex.

```
10 REM Lissajous Curves
20 REM by Reza Jugon
30 MODE 4
40 INPUT "WHAT TWO NUMBE
RS",A,B
50 CLS:T=0
60 MOVE 1200,500
70 X=600+600*COS(A*T)
80 Y=500+500*SIN(B*T)
90 DRAW X,Y
100 T=T+.01
110 GOTO70
```

Bleep, bleep!

WHEN this program is run it will enable the BBC to respond to a key being pressed with a bleep.

```
10 code%=&k70
20 P%=code%
30 ?&0220=code% MOD 256
40 ?&0221=code% DIV 256
50 [
60 LDA#&07
70 JSR &FFEE
80 RTS
90 ]
0070
0070 A9 07 LDA#&07
0072 20 EE FF JSR &FFEE
0075 60 RTS
```

To switch the bleep on and off use *FX 14,2 / *FX 13,2 respectively.

If you have version 1.0 OS then you will be able to vary the type of bleep you get using the following FX calls:

*FX 211,X where X is the channel number.

*FX 212,X where X is an envelope number (0-127 in steps of 4).

*FX 213,X where X is the pitch (0-255).

*FX 214,X where X is the duration (0-255). — Anwar Ali, Birmingham.

iDigamé por favor!

SINCE your magazine seems to be the fount of all wisdom on matters Beeb, perhaps you can

explain something for me.

I am trying to write programs to help my students revise their Spanish. In order to do this I include a procedure which defines the function keys f0 to f7 as the Spanish accented vowels, ñ, and upside down exclamation and question marks.

By using the VDU23 command the function keys produce the relevant letters etc. when the shift key is held down and Mode 6 is being used.

Now for the query. When I am keying in a program in Mode 7, the function keys, when pressed, naturally leave a blank on the screen, but any letters following my user defined f-keys appear in colour — red after é, green after î, yellow after ó, blue after ú, magenta after ñ and

The Real Thing

Circulation figures of a publication can be a mystery to advertisers

OUR GUARANTEE

The circulation of this publication is audited independently to the highest professional standards and certified by the Audit Bureau of Circulations

ABC

The Hallmark of Audited Circulation

MICROMAIL

From Page 205

cyan after the upside down question mark. Why?

But the mystery deepens (for me at any rate) when I run a program incorporating this procedure and then LIST it.

No matter whether in Mode 6 or Mode 7, the accented vowels show up in the DATA statements as follows (in the order a to u) AND, DIV, EOR, MOD, OR, while ñ prints as ERROR and the upside down question mark and exclamation mark show up as LINE and OFF respectively.

Despite this the READ statement usually reads them as Spanish accented vowels etc

though not always.

Is there any explanation for this and is there any way round it, for example another way of defining the function keys to produce the results I want?

I enclose a copy of the procedure which I took from another less well-known magazine! — A.S. Dawson, Meols, Wirral.

● The problem arises from the other magazine being, I suspect, inadvertently quoted out of context.

The user defined characters you quote, which we cannot print for copyright reasons, run from code 128 onwards.

Now the BBC Micro will accept a continuous block of 32 characters as user defined from

wherever you care to start, without having to resort to esoteric exploding of the character set.

However, most of us use the already free characters from 224 to 255. This is what we would suggest you do, substituting in the VDU 23 statements 224 for 128, 225 for 129 and so on. (And, of course, in the lines where they are invoked.)

In Mode 7 there aren't any user defined characters. The codes from 128 on are deliberately used to change the colour and other attributes of characters on a line — hence your difficulties. See Nigel Peters' superb introduction to this in the August and Septem-

ber 1984 issues of *The Micro User*.

Your problems in the data statements belie a certain sophistication in your programming. You must have POKED the values into the data statements using the indirection operators.

When the micro comes to read these bytes, it assumes that everything is still according to the rules of Basic and interprets the lines accordingly.

The numbers 128 and so on are already reserved by Basic as the codes, or tokens, for the words AND, DIV and so on. Hence the latter appear on your screen when the program is listed.

And finally, with tongue firmly in cheek . . .

A red letter day for Wally

Dear Trev,

I'm not sure if I should tell you this — I was sworn to secrecy on a copy of the User Guide — but I've just returned from a pilgrimage to the Micro User offices.

What happened was that I won the last competition. The first prize was "a day with the wacky, zany Micro User team".

Well, I say that I won it, but that's not really true. It was Andrea who cut out the coupon and sent it in using my name.

She won't tell me what her entry was and Micro User say they daren't publish it, but it won.

The first I knew about it all was when a shifty looking person sneaked up to our door and shoved a grubby handwritten note into my hand.

"That's been smuggled out of the Micro User offices", he whispered furtively. "Don't tell a soul".

Trembling with anticipation I opened it. "Dear Wally, Congrats you've won the prize. Report to the office on Monday and don't forget the coffee. — The Beeb team. P.S. Eat this note."

Well, I could hardly contain myself. I didn't eat the note — relics like that are too valuable. I still have it pressed in the pages of my Remedial Users Guide.

Anyway, I turned up at Micro User House and introduced myself to the receptionist.

"I'm sorry, they're not taking calls today", she told me, sympathetically.

"But I'm expected", I whimpered.

"Maybe that's why they're not taking calls", came the retort.

A lesser man might have been daunted, but I knew exactly the right psychological approach. I screamed and bawled, cried, yelled and eventually held my breath. And it worked.

"All right, you win. They're upstairs, second door on the right. The one marked 'Abandon hope all ye who enter here'".

Shaking with excitement I mounted the stairs and there before me was the door of the Micro User offices. I knocked, reverently.

"Go away!"

I knocked again.

"We're not here".

"I'm the one who won the prize", I wailed.

The door was flung open.

"Why didn't you say so? Come in. Did you bring the coffee? Hey lads, it's Wally. Welcome to the Black Hole of Hazel Grove".

And with that I entered the inner sanctum of The Micro User.

I'm afraid I can't tell you much about the place itself. As I've said, I was sworn to secrecy. However, there are bits that I can reveal.

Imagine a small, airless room. In it toil three dedicated men, all with an attitude of quiet desperation. A tense silence prevails, broken only by cries of "Mode 7" as the Micro User team taunt the Editor of Electron User.

Too scared to break their concentration I

stayed in the background, endlessly making cups of coffee. Suddenly the pressure eased.

"Lads, I've got the answer to five down. It's 'SYNTAX ERROR'. No wonder we couldn't get it!"

With groans of relief the team relaxed and put down their crosswords.

"Right then", cried the Editor, "they're not open, so we may as well work on the mag. Anyone know what a TAB statement is?"

Before I could reply the door burst open and in came a cross between the Ancient Mariner and Alice's rabbit.

"Lads, lads", he cried, "I've got a great idea. We'll get all sorts of utilities and games for the Beeb, add a few news stories and letters and things and issue it as a special. What about that then?"

The team looked at him in pity. The Editor got up, put an arm around his shoulders and took him out.

"Dick", he said gently, showing him the infinite patience of the truly great, "we're already doing it. It's called The Micro User".

As he led him away I looked at the others for enlightenment.

"That's the Dungeon Master. He owns the place. Hasn't been the same since he tried to go solo on a QL. Damn bad show".

And that's really all I can tell you. I never met Alice. Apparently she was in one of the rooms but we never found the right one.

Be good,

Bob



The Micro
 the data
 certain so-
 rogramm-
 e POKEd
 data state-
 ndirection
 comes to
 umes that
 ording to
 interprets
 and so on
 y Basic as
 for the
 d so on.
 r on your
 ogram is

making
 eased.
 e down.
 nder we

relaxed

"they're
 on the
 statement

st open
 Ancient

a great
 es and
 stories
 it as a

ty. The
 nd his

him the
 "we're
 Micro

others

e owns
 nce he
 show".
 I never
 of the
 one.

Bob

Increase profits on your BBC Micro sales with the Viglen[®] ROM Cartridge System!

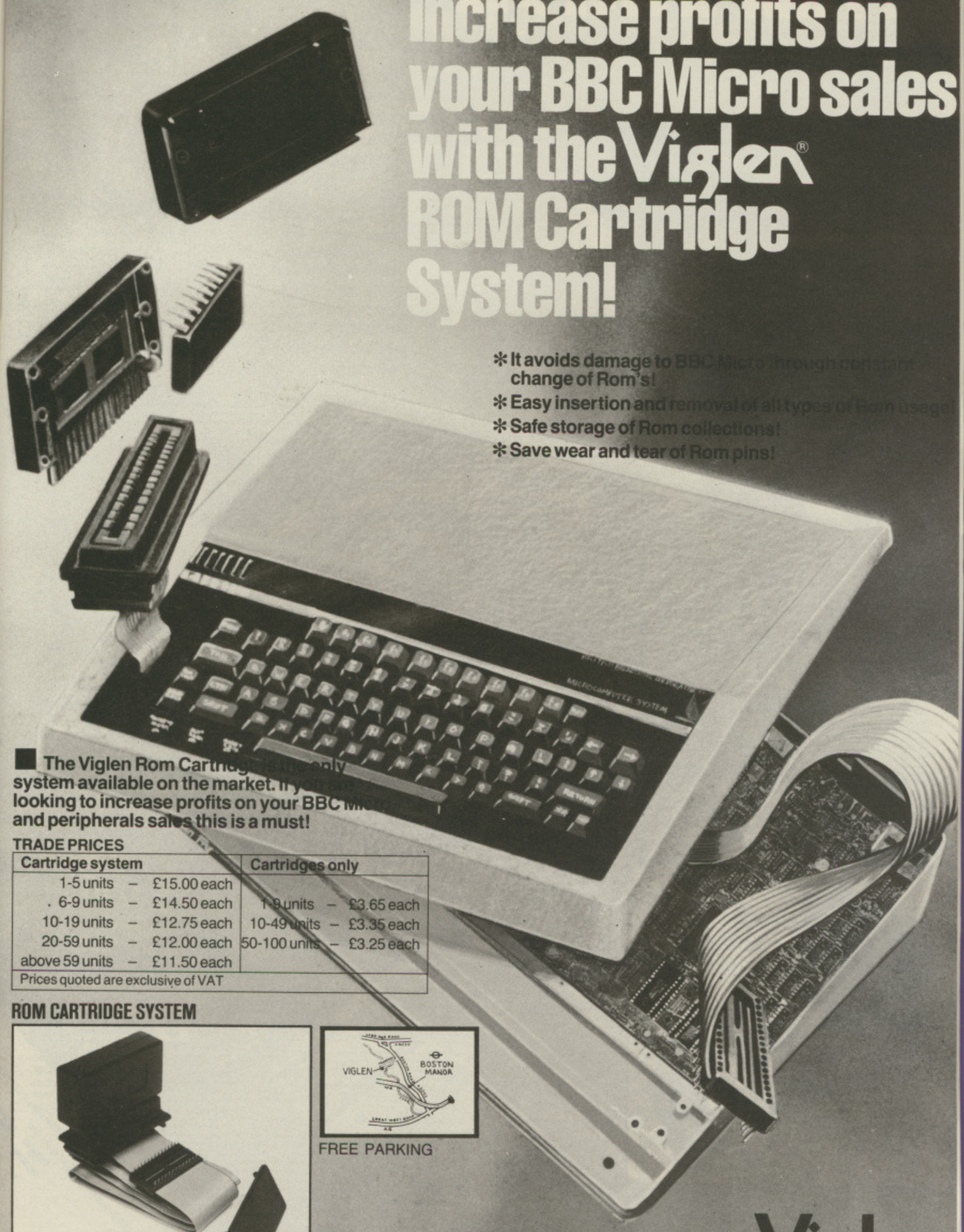

- * It avoids damage to BBC Micro through constant change of Rom's!
- * Easy insertion and removal of all types of Rom usage!
- * Safe storage of Rom collections!
- * Save wear and tear of Rom pins!

■ The Viglen Rom Cartridge is the only system available on the market. If you are looking to increase profits on your BBC micro and peripherals sales this is a must!

TRADE PRICES

Cartridge system	Cartridges only
1-5 units - £15.00 each	1-9 units - £3.65 each
6-9 units - £14.50 each	10-49 units - £3.35 each
10-19 units - £12.75 each	50-100 units - £3.25 each
20-59 units - £12.00 each	
above 59 units - £11.50 each	

Prices quoted are exclusive of VAT

ROM CARTRIDGE SYSTEM

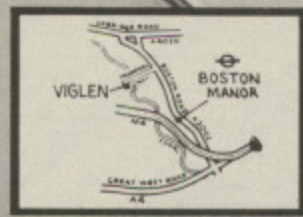

FREE PARKING

ALL TYPES OF TRADE INQUIRIES INVITED

Tel: (01) 843 9903

...FOR A FAST FRIENDLY, PERSONAL SERVICE.

Viglen
 COMPUTER SUPPLIES
 Unit 7 Trumpers Way
 Hanwell W7 2QA
 Tel: (01) 843 9903

FROM VIGLEN®

Complete ROM Cartridge System for the BBC Model B.

... store your growing collection of ROM's in purpose-made protective cartridges! Insert and remove from your micro in absolute safety without ever damaging the pins of your ROM's!

... your BBC Micro comes complete with a special vent on the left hand side of the keyboard (see 6), and unused ROM sockets (see 10).

The Viglen ROM Unit consists of a "ROM plug" (see 9), which plugs in to the "ROM socket" (see 10), which passes under the BBC outer case (see 5) through the vent (see 6), and connects perfectly on to the vent.

Connect the ROM Chip (see 2), place ROM Cartridge Cup, IM and the unit is fully operational. Once this simple process is done you simply plug in the ROM Cartridge (see 3).

You may have as many "ROM Cartridges" as you wish - say, word processor, accounting, spread sheets etc., simply plug in to the ROM Cartridge Socket!

The "VIGLEN ROM CARTRIDGE SYSTEM" comes complete with ROM (1 & 3), ROM CARTRIDGE SOCKET (4), ROM CABLE (8), ROM PLUG (9) and cover.

Complete Kit, including one cartridge £19.95 inc VAT.
 5 Extra ROM Cartridges £27.75 inc VAT.
 10 Extra ROM Cartridges £49.50 inc VAT.
 Single Cartridge £6.95 inc VAT.



ROM CARTRIDGE SYSTEM



Viglen®
 COMPUTER SUPPLIES

Unit 7 Trumpers Way
 Hanwell W7 2QA
 Tel: (01) 843 9903



FREE PARKING

HOW TO ORDER.

By Post

To purchase your special ROM Unit, fill in the coupon below, enclosing your cheque/
 P.O. made payable to VIGLEN COMPUTER SUPPLIES and post to us.

By Telephone

If you are an Access/Barclaycard holder you may order by telephone,
 simply give your Card No., name and address and item(s) required.

In Person

You are welcome to visit us; the nearest underground station
 is BOSTON MANOR.

Please allow 7-28 days for delivery.

Post to: Viglen Computer Supplies, Unit 7, Trumpers Way, Hanwell, London W7 2QA. Viglen ROM Units at £19.75

Please send me (state No. required)

I prefer to pay with my ACCESS/BARCLAYCARD (delete whichever not applicable)

Card No. _____

Signature _____

Name _____

Address _____

Credit cards valid if signed by cardholder. Address above must be the holder's as card holder.

Put an end to inefficient, slow cassette tape storage



Speed your data access with a TEAC disk drive from Viglen

Comprehensive, fact-filled, 53 page manual including techniques of loading from cassette to disc. Not available elsewhere

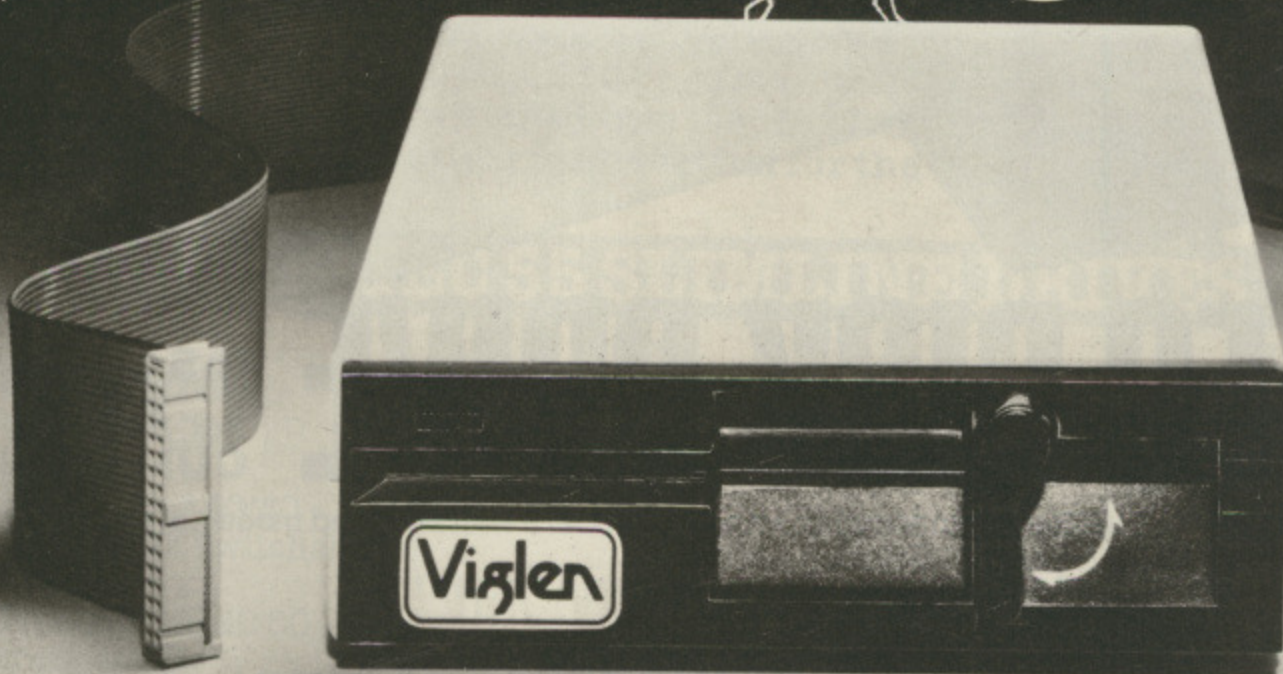

Replacing your cassette with a disk drive means data access in seconds! VIGLEN TEACS *unlike others* have been specially modified to operate successfully with ACORN and other filing systems, over coming RANDOM accessing problems normally experienced with these disk drives. Prices include VAT, Formatting Disk, User Manual, Case and Leads.

When ordering Dual Drives, please state which layout you prefer. A or B.

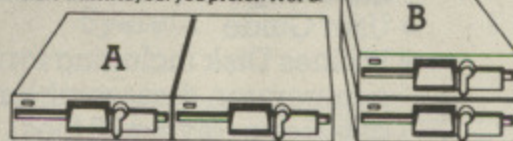

TEAC 55 Slimline Drives					
SINGLE DRIVES CASED	Incl. VAT	Excl. VAT	DUAL DRIVES CASED	Incl. VAT	Excl. VAT
40 TRACK 100K	£119.00	£103.48	40 TRACK 200K	£240.00	£208.69
40 TRACK 200K	£160.00	£139.13	40 TRACK 400K	£280.00	£243.48
40/80 TRACK 200K	£140.00	£121.74	40 TRACK 800K	£378.00	£328.70
40/80 TRACK 400K	£189.00	£164.35	Integral dual power supply	£45.00	£39.13

All prices correct at time of going to press and all offers subject to availability.

● Utilities disk includes 13 useful utilities including: ● formatting ● verifying ● screen dump ● disassembler ● generating 62 files, etc. Please telephone 01-843 9903 for latest prices

● Orders welcomed from Educational Establishments and Government Departments.

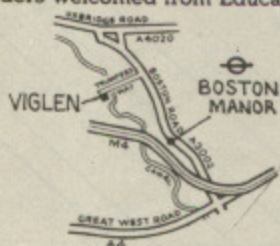

Full Twelve Months Guarantee

How to order

By post: To purchase any of the items simply fill in the coupon with your requirements. Enclose your Cheque/P.O. or use your Access/Barclaycard. Please make cheques payable to: VIGLEN COMPUTER SUPPLIES and post to above address. Allow seven days for delivery and add £8.00 carriage, package and insurance on all items.

By telephone: Ring (01) 843 9903. Credit Card holders (Access/Barclaycard only) can purchase by telephone. Please give Card No., Name, Address and the items required.

Viglen

COMPUTER SUPPLIES

Unit 7 Trumpers Way
Hanwell W7 2QA
Tel: (01) 843 9903

EASY-ON-THE-SPOT PARKING. AND IT'S FREE!
Post to: VIGLEN COMPUTER SUPPLIES UNIT 7, TRUMPERS WAY, HANWELL, W7 2QA

Please send me the following items:

I enclose Cheque/P.O. for £ _____
I prefer to pay by ACCESS/BARCLAYCARD* Card No. _____

Signature _____
Name _____
Address _____

*Delete as necessary

MU10/1

Switchable 40/80 Track 200K Disk Drive & Acorn DFS



THE TEC DISK DRIVE

(AS USED BY CUMANA)

COMPLETE DISK SYSTEM FOR THE BBC MODEL B

• Package assumes you own a BBC Model B with switched mode power supply plus 1.2 operating system.

OFFER INCLUDES:

- Disk Interface (call at factory for free fitting)
- 200K 40/80 track single sided TEC FB502 Slimline Disk Drive including case and all leads
- User Guide
- Utilities Disk including formatting, verifying, BASIC program comparator, disassembler, Epson screen dump, dual catalogue (giving 62 files), large printing and others

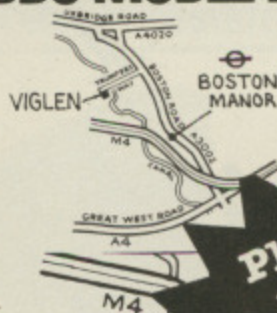

Please Ring 01-843 9903 for LATEST PRICES

SWITCHABLE DISK DRIVE & ACORN INTERFACE
£239
INC VAT

Viglen
COMPUTER SUPPLIES
Unit 7 Trumpers Way
Hanwell W7 2QA
Telephone: (01) 843 9903
AMPLE ON-THE-SPOT
CAR PARKING -
AND IT'S FREE!

Prices correct at time of going to press - offer subject to availability

Post to: VIGLEN COMPUTER SUPPLIES UNIT 7, TRUMPERS WAY, HANWELL, W7 2QA

Please send me _____ (Qty) TEC 200K + DFS

I enclose Cheque/P.O. for £ _____

I prefer to pay ACCESS/BARCLAYCARD (Delete whichever not applicable) Card No. _____

Signature _____

Name _____

Address _____

made out to VIGLEN COMPUTER SUPPLIES (please add £8 for carriage)

Order with your £1000 Visa or Mastercard and we'll give you a special price

MU101/5

Buy from the specialists.

VIGLEN offer of TEC drives (As used by Cumana) beats all comers

Replacing cassettes with disc drives means programme loaded and data accessed in seconds not minutes.

Our guaranteed disc drives are supplied with a comprehensive fact-filled 53 page manual, exclusive to Viglen, which shows loading from cassette to disc and other information for the BBC Model B.

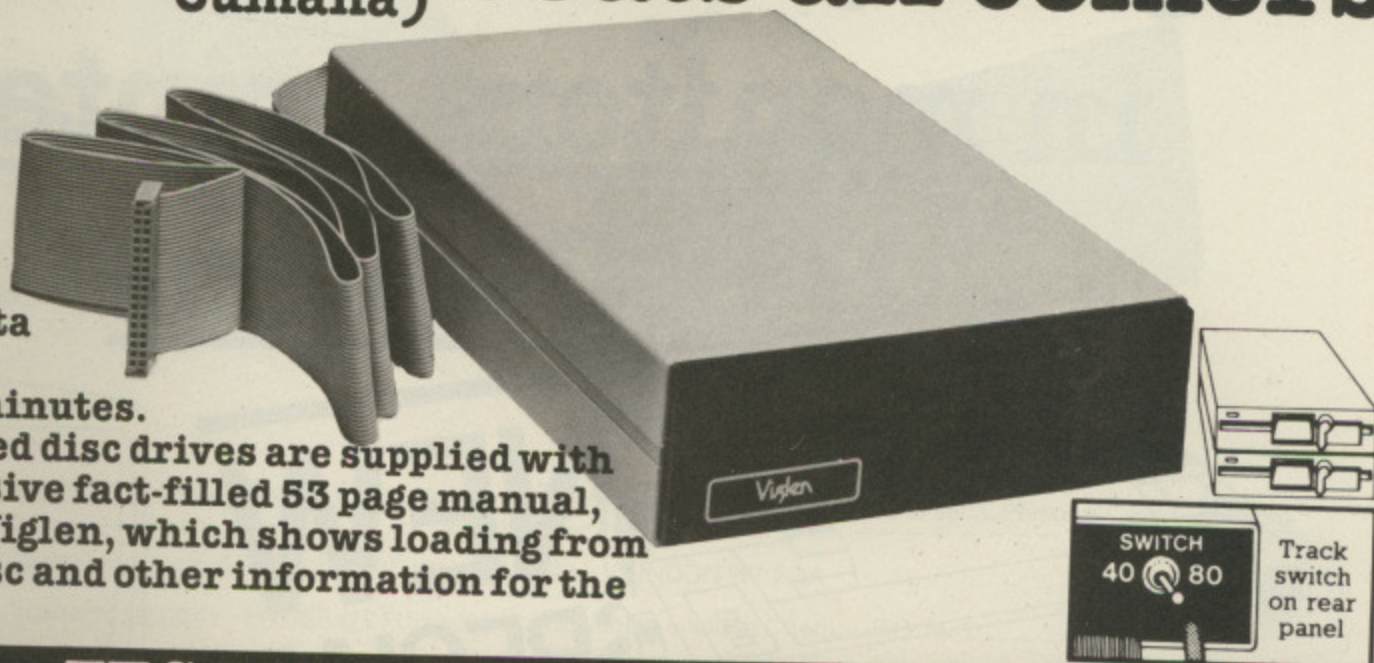

TEC 55 SLIMLINE DRIVES

Single Drives	Incl VAT	Excl VAT	Dual Drives	Incl VAT	Excl VAT
40 Track 100K 5 1/4"	£119.00	£103.48	40 Track 200K 40/80 Track	£238.00	£206.96
Single sided 40/80 track 200K switchable 5 1/4"	£139.00	£120.87	Switchable 400K 40/80 Track	278.00	£241.74
Double sided 40/80 track 400K switchable 5 1/4"	£179.00	£155.65	Switchable 800K	358.00	£311.30
Integral Power supply for single drive	£25.00	£21.74	Integral Power supply for dual drive	£45.00	£39.13
			ACORN Disc Filing System	£105.00	£91.30

Please Ring 01-843 9903 for LATEST PRICES

Viglen

COMPUTER SUPPLIES

Unit 7 Trumpers Way
Hanwell W7 2QA
Telephone: (01) 843 9903

All prices correct at time of going to press and all offers subject to availability. All disk drives are supplied complete with Professional Screened Case - Ribbon Cable to connect to BBC Micro - Power Cable to connect to BBC Micro - Comprehensive Manual - Formatting and utilities disc, which includes 13 useful utilities including * formatting * verifying * screen dump * dis-assembler * generating 62 files, etc.

• Orders welcomed from Educational Establishments and Government Departments

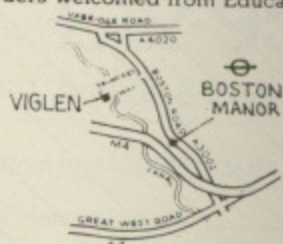

Full Twelve Months Guarantee

How to order

By post: To purchase any of the items simply fill in the coupon with your requirements. Enclose your Cheque/P.O. or use your Access/Barclaycard. Please make cheques payable to VIGLEN COMPUTER SUPPLIES and post to above address. Allow seven days for delivery and add £8.00 carriage, package and insurance on all items.

By telephone: Ring (01) 843 9903. Credit Card holders (Access/Barclaycard only) can purchase by telephone. Please give Card No., Name, Address and the items required.

AMPLE ON-THE-SPOT CAR PARKING - AND IT'S FREE!
Post to: VIGLEN COMPUTER SUPPLIES UNIT 7, TRUMPERS WAY, HANWELL W7 2QA
Telephone: 01-843 9903. Personal Callers Welcome.
Please send me (state number required)
I enclose Cheque/P.O. for £ _____
I prefer to pay ACCESS/BARCLAYCARD (Delete whichever is not applicable)
Card No. _____
Signature _____
Name _____
Address _____
Incl £8 carriage Cheques payable to Viglen Computer Supplies
Credit cards valid if signed by card holder. Address below must be the same as card holder.

MU10/2

VIGLEN

gives you the best value
in monitors, printers
& BBC Micros

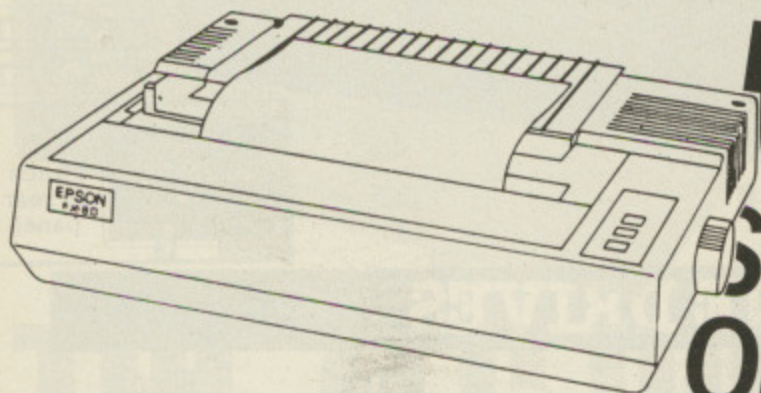

**NEW
SPECIAL
OFFERS**

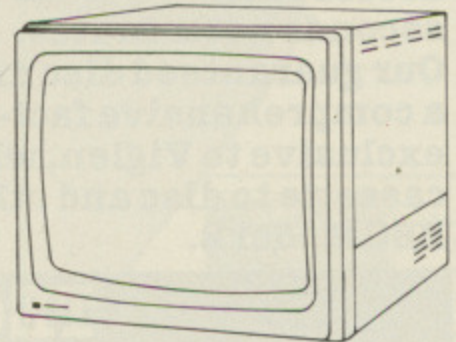

Dot Matrix Printers

Epson RX 80/FT Brand leader. A reliable well established printer with friction and tractor feeds. 80 cps **£275** (inc VAT)
 Epson FX 80 The upmarket printer from the Epson range. 160 cps. All other facilities you would expect. Competitively priced at **£379** (inc VAT)
Canon PW 1080 A-KAGA-TAXAN. New printer recently reviewed shows near letter quality printing from dot matrix printer. Friction and tractor feeds. 160 cps. Highly recommended. **£289** (inc VAT)
 Shinwa CP80 **£199** (inc VAT)

Daisywheel Printers

Juki 6100 **£375** (inc VAT)
 SAN PLE 2000 **£229** (inc VAT)

All prices include leads for BBC Micro and VAT. Please add £8.00 for carriage. We also stock other computer peripherals, accessories and complete work processor systems at unbelievable prices. Please call for our latest offers. You may also purchase these items direct by calling at our factory/showroom in Hanwell, London. Prices correct at time of going to press and offers subject to availability.

Please add £8 for 1½ metre printer lead for BBC Micro

Colour Monitors

Microvitec standard 1431 **£189** (inc VAT)
 Microvitec medium 1451 **£305** (inc VAT)
 Microvitec high 1441 **£442** (inc VAT)
 Philips 14" TV/monitor **£235** (inc VAT) (RGB Input)

Monochrome Monitors

Philips 12" Green V2001 **£75** (inc VAT)
 High-resolution

BBC Micros

Model B **£369** (inc VAT)
 Model B + DFS **£459** (inc VAT)

**Please Ring
01-843 9903
for LATEST
PRICES**

AMPLE ON-THE-SPOT CAR PARKING - AND IT'S FREE!
 Post to: VIGLEN COMPUTER SUPPLIES UNIT 7, TRUMPERS WAY, HANWELL W7 2QA

Please send me (state number required)
 I enclose Cheque/PO. for £
 I prefer to pay ACCESS/BARCLAYCARD (Delete whichever is not applicable)

Card No. _____
 Signature _____
 Name _____
 Address _____

Credit cards valid if signed by card holder. Address below must be to a single adult holder.

MU10/4

UNBEATABLE VALUE!

£115
inc VAT
+ £8 carriage

CANON 200K DOUBLE SIDED

Model No. MDD210

40 track 200K
DOUBLE SIDED

★ low power consumption
(unlike full height drives)

All disc drives come complete with Professional Case – Ribbon cable to connect to BBC Micro – Power cable to connect to BBC Micro – Comprehensive Manual – Formatting and utilities disc.



Viglen

COMPUTER SUPPLIES

VIGLEN COMPUTER SUPPLIES, UNIT 7 TRUMPERS WAY, HANWELL, LONDON W7 28A. Telephone 01-843 9903. Personal Callers Welcome.

Post to: VIGLEN COMPUTER SUPPLIES, UNIT 7, TRUMPERS WAY, HANWELL, LONDON W7 2QA.

MU10/7

Please send me _____ (qty.) CANON MDD210 DRIVES at £115 each + £8 carriage. I enclose Cheque/P.O. for £ _____ made out to VIGLEN COMPUTER SUPPLIES or debit my ACCESS/BARCLAYCARD No. _____

Name _____



Signature _____

Address _____

NEW!

from

Viglen

COMPUTER SUPPLIES

A PRINTER STAND

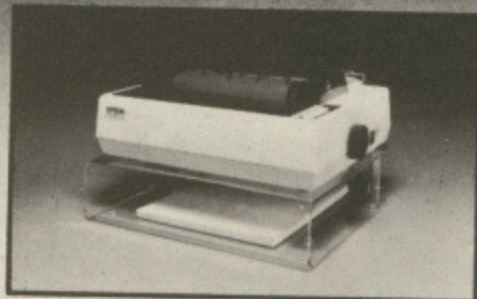

Printer Stand

£12.95 INC. VAT

Carriage & Packing £3.00

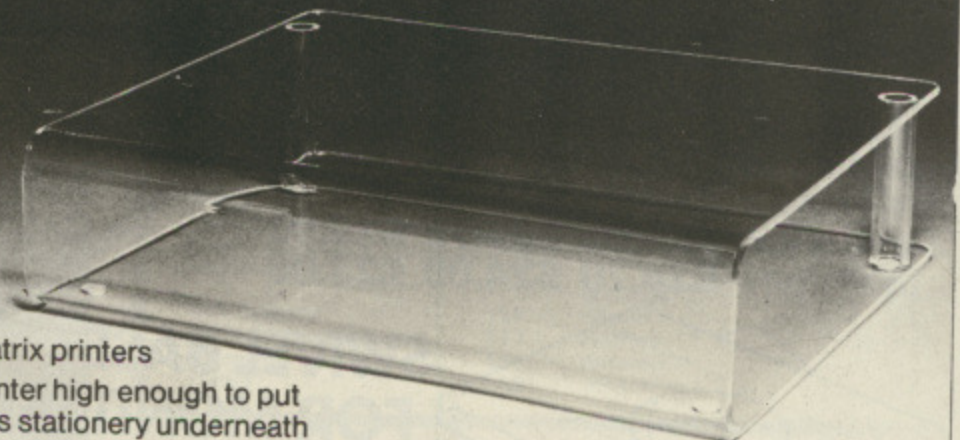

- For dot matrix printers
- Raises printer high enough to put continuous stationery underneath
- Beautifully finished in clear perspex • Viglen quality every time
- Will accept paper up to 12½" wide • Non slip rubber pads

Dimensions: 15" (380mm) wide 12½" (320mm) deep 4" (90mm) high

COME TO VIGLEN FOR A FAST, FRIENDLY, PERSONAL SERVICE

DEALER ENQUIRIES WELCOME

Post to: VIGLEN COMPUTER SUPPLIES, UNIT 7, TRUMPERS WAY, HANWELL, LONDON W7 2QA.

MU10/6

Please send me _____ (qty) PRINTER STANDS at £15.95 each. I enclose Cheque/P.O. for £ _____ made out to

VIGLEN COMPUTER SUPPLIES or debit my ACCESS/BARCLAYCARD No. _____

Name _____



Signature _____

Address _____

NEW!

FROM Viglen



— Full Twelve Months Guarantee —

DISK STORAGE

No. 1

This diskette storage holds 70 diskettes

Our **SUPER LOW**

price **£18.00** Including VAT

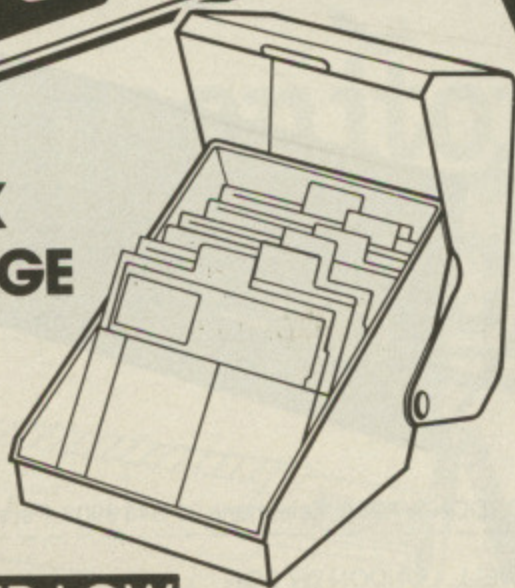

COMPUTER SUPPLIES

Unit 7 Trumplers Way Hanwell W7 2QA Tel: (01) 843 9903

DISK STORAGE

No. 2

This lockable diskette storage holds 80 diskettes

Our **SUPER LOW**

price **£18.00** Including VAT

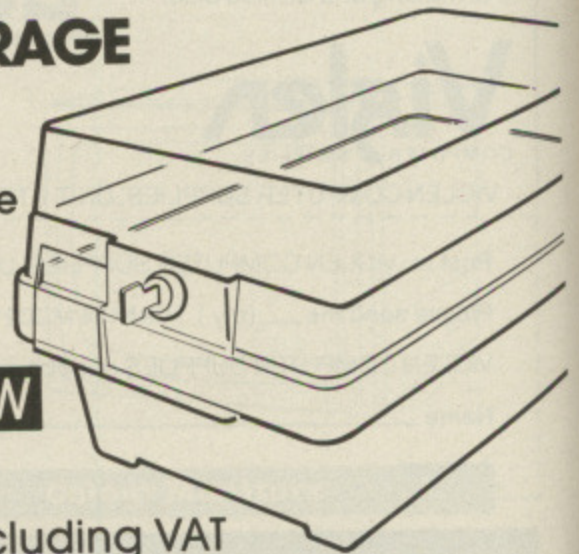

3M SCOTCH DISCS

5 1/4" diskettes single sided

Our **SUPER LOW**

prices Inc.VAT

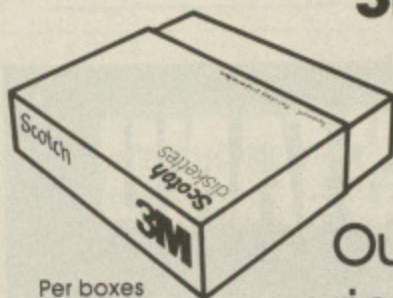

Per boxes of 10

boxes	1-2	3-9	10+
SS 40 TRACK	£15.00	£13.50	£13.00
DS 40 TRACK	£20.00	£18.40	£17.70
SS 80 TRACK	£23.00	£20.70	£20.00
DS 80 TRACK	£26.70	£24.00	£23.00

PERSPEX KEYBOARD STOWAWAY & VDU STAND

Our **SUPER LOW** price

£14.95

Inc VAT

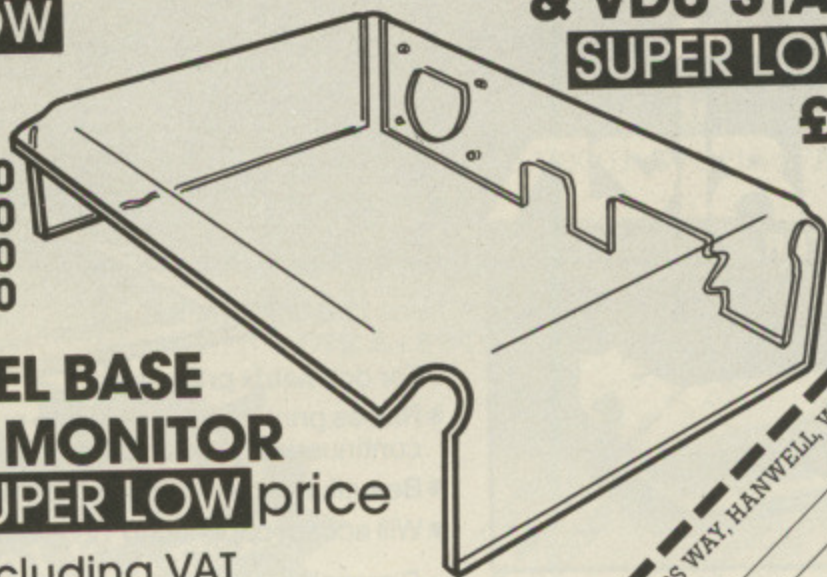

SWIVEL BASE FOR MONITOR

Our **SUPER LOW** price

£16.00 Including VAT

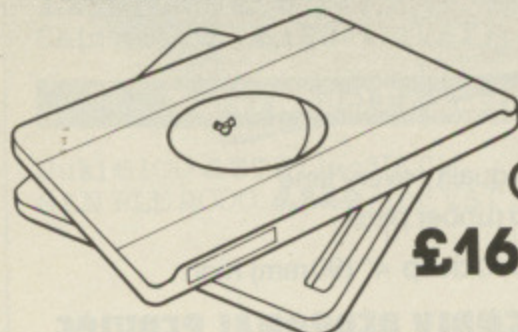

GRAFPAD Our **SUPER LOW** price

£143.75 Including VAT

This remarkable Grafpad from British Micro allows you to input information into your computer - very accurate and high resolution, not to be confused with other models which are both more expensive and less accurate. Supplied with all necessary cables, manual and sample programs, to allow you to develop your own application programmes.

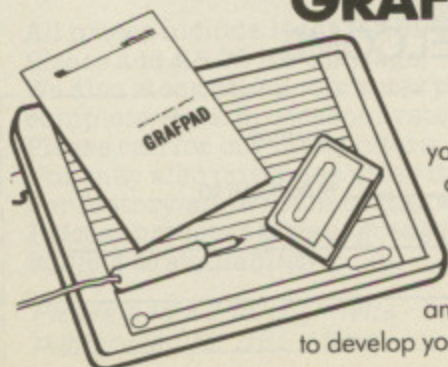

AMPLE ON-THE-SPOT PARKING. AND IT'S FREE!
Post to: VIGLEN COMPUTER SUPPLIES, UNIT 7, TRUMPERS WAY, HANWELL, W7 2QA. Tel: 01-843 9903

Please send me the following items:

I enclose Cheque/P.O. for £
I prefer to pay by ACCESS/BARCLAYCARD* Card No.

Signature

Name

Address

All items £2.00 only for p & p.
*Delete as necessary

MU101/3

THE MICRO PULSE EXTERNAL ROM BOARDS

For the BBC Computer and the Acorn Electron

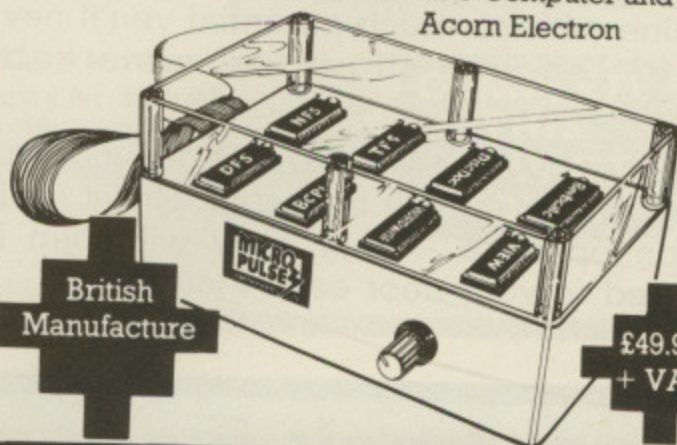

British
Manufacture

£49.95
+ VAT

- ◆ BRITISH MANUFACTURE ◆ ALLOWS 8 ROMS ON LINE
- ◆ HARDWARE-BASED ROM SELECTION AVOIDS SOFTWARE INTERACTION BETWEEN UTILITY ROMS
- ◆ SWITCH TO REQUIRED ROM USING MANUAL SWITCH OUTSIDE THE UNIT
- ◆ RED LIGHTS INDICATE THE SELECTED ROM
- ◆ HIT "BREAK" TO ACCESS ROM, NO NEED TO USE SOFTWARE COMMAND
- ◆ INCLUDES ZIF SOCKET, FOR INSTANT CHANGING OF A SELECTED ROM
- ◆ INCLUDES BBC CABLE AND ROM SOCKET CONNECTOR
- ◆ INCLUDES SIMPLE FITTING INSTRUCTIONS, JUST PLUG IN AND GO!

please contact: Gareth Litter
Mark Howard or
Judith Allen at
Micro Pulse
Division

**northern
computers**

Churchfield Road,
FRODSHAM
Cheshire WA6 6RD
Tel: 0928 35110

THE MICRO PULSE 5.25" DISC DRIVES

ANNOUNCEMENT

- * Northern Computers announce 6 new models of Micropulse 5.25" disc drive, manufactured and assembled in the North West, for the BBC computer. These drives are exactly compatible with the two Acorn/BBC disc formats. They are based on the highest quality Teac mechanisms with built-in power supply, as previously supplied by Cumana Ltd.

- * Prices from **£119.95** + V.A.T.
- * Also: High Quality 3" Compact Disc Drives
- * Prices from **£129.95** + V.A.T.
- * Each Micropulse disc drive is supplied with a BBC cable, formatter utility disc and comprehensive 55page disc filing system manual for the BBC computer.
- * For further details send large S.A.E. to :

**northern
computers**

Northern Computers,
Churchfield Road,
FRODSHAM
Cheshire WA6 6RD
Tel: 0928 35110

ADVERTISERS INDEX

Addictive Games	94	MRM	117
Aries Computers	73	Mayday Software	179
ATPL	155	Microman Computers	195
A&F Software	112, 113	Mighty Micro	184
Alligata	102	Micropower	6, 49, 96, 123, 220
Acorn	20, 21, 67, 86, 87	Multiplex Computer Services	182
Akhter Computers	190	Michael Business Systems	167
A1 Business Computers	192	MP Software	52
		Mirra Systems	179
Beltech	131	Micronet	88, 89
Beebugsoft	18, 19, 132, 133	Millsoft	198
Brother	95	Microjen	196
Benwick Electronics	164	Microvitec	188
BBC Publications	70	M-Tec	156
British Micro	218	Microtest	106
		Micro-Jenn Software	196
Corgi Books	15	Microfax	196
CJE Micro	53	Microwriter	124, 125
Cambridge Computers	163	Musicsoft	195
Chase Data	90, 91	M-T Direct	34
Computer Room	194	Microware	35
Care Electronics	180	Mayfair Micro	167
Compuchess	166		
Contex	142	Northern Computers	215
Clares	12, 13	Newark Video	193
C-Tech	138, 139	National Extension College	196
Cumana	32	National Micro Centres	108, 109, 193
Computerama	3		
Computer Concepts	46	Opus	7, 11, 14, 193
Carson Developments	113		
Commotion	200	Proxima	182
		PV Tubes	167
Data Efficiency	59, 77	Pace	22, 187
Datapen	156	Prism	68, 69
Disking	82, 83	Printerland	191
Dataware	112	P & H Electronics	134
Datatar Systems	175		
D.E. Systems	192	Qualsoft	176
Dee Kay Systems	177	Quest	10
Discotechnology	63		
		Racey Designs	215
Electrolink	198	Ricksoft	142
Evansoft Software	173		
Ephagy Software Products	198	Statacom	184
Electronequip	140, 141	SP Electronics	173
		Small School Software	193
Guardian Software	156	Silent Computers	163
GSL	50	Stack	151
		Skywave Electronics	165
HCR Electronics	194	Software Division	173
Hornby Software	196	Sir Computers	195
Heliwell	173	System	74
HAL Computers	2	Superior Software	116, 219
Home and Business	194	Software Invasion	99
		Systematics International	33
Icon	79	SCI UK	36, 38
Intec	118	Solidisk	8, 9
Integrex	159		
		Tatung	31
JP Magnetics	177	Tutorial Software	180
J. & W. Bunce	191	Tekform Products	164
		Torch	16, 17
Kosmos	164	Twilstar	169, 171, 173, 175, 177, 179
Kay-Ess	62	Technomatic	143-148
		Tradelink UK	184
LVL	98, 99		
Lifelong Learning	177	United Disk Memories	54
Logical Educational	198	U-Micro	180
LCL	166		
Lion Viewdata	182	Vision Products	177
Lowmac Software	179	Vine Micros	192
Leigh Computer Systems	151	Viglen	207-214
Level 9 Computing	130		
Logotron	28	Wildings	197
		Wizard	62
MW Systems	199	Watford	38-45
Minic Business Services	177	Wisowl	76
Micro-Aid	136	John Wiley	191
Merlin	58		

BBC Volume Control

At last turn your sound UP/DOWN or OFF with this variable volume control. Fitted discreetly to the back of your Beeb.

Easy to fit. Some soldering necessary.
KIT OF PARTS & STEP BY STEP INSTRUCTIONS

ONLY £2.80 inc.

Racey Designs
47 Twycross Road,
Burbage Leics. LE10 2SF

THE MICRO USER

It's the biggest, brightest, most authoritative yet completely independent guide to the machine with so much potential you'll never tire of reading about its remarkable capabilities.

You can buy *The Micro User* from your local newsagent or station bookstall. Or fill in the coupon opposite - your copy will then be delivered to your door each month.

Copies of *The Micro User* back issues are still available at £1.50 each

Cassette tapes and discs of Micro User Programs

Take our a year's subscription and have your cassette or disc posted to you each month. Start your subscription from any You can order on the coupon opposite. Contents are listed below:

MARCH 1983: Deathwatch, a superb arcade game. Bingo, clever uses of the randomise function; Bubblesort routines; Tests function keys in machine code. 0.1 Colour and Graphics Routines: create a kaleidoscope of screen designs.

APRIL: King Kong, rescue girls from the Empire State Building before killing Kong. Nim, a structural game of strategy. Tokens, unravel the Basic ROM; Formatter, an essential disc utility; Disassembler, a full machine code disassembler.

MAY: Air Strike, a fast and furious arcade game; Test your mental powers with Pelmanism; Anagrams, the word game. Character, generate vertical and inverted text. Teletext, animation in Mode 7. Beeb, two joystick exercises.

JUNE: Space Pilot, lost in space you must fight off repeated attacks from alien life forms. Nomism, you are a nomadic herdsman desperately trying to eke out a living on the plains of Africa. Colourful Characters Plus other listings from the June issue.

JULY: Tenpin, a simulation of Tenpin Bowling; Spacepods, beat the alien hordes; Cup, exciting 3D graphics techniques Test and Steady, programs to accompany the Beeb Body Building Course. Breakfix, don't let Break destroy your precious variables!

AUGUST: Fruities, driven by strange urges you climb the ladders of adventure to risk all in the gardens of unearthly frights. Animation, a suite of programs that really bring your screen alive; Casdisc, the machine code downloader for your disc system; Mode 7 colour routines.

SEPTEMBER: Robin & Marian, rescue Maid Marian from the Sheriff of Nottingham. Galactic Invaders, an exciting arcade game. DFS Benchmarks, 14 DFS test programs. Animation, new techniques. Terminal, connect a BBC Micro to a mainframe.

OCTOBER: Fishing, a compulsive day's angling. Joykey, convert programs to joystick. Pentest and Bellringer, for Micro User lightpens. Contours, an educational program. Link BBC Micros to each other. Plus all the listings from the first Electron User.

NOVEMBER: Goblins, an enchanted journey. Blackjack, the casino favourite. Charge and Pendulum, Body Building Course part 9. Sideways, programs in ROMs. Pendraw, a light pen sketching program. Plus all the programs from the second Electron User.

DECEMBER: Tower, rescue London's treasure. Santa, help Father Christmas. VDU 23, an invaluable character defining utility. Paged, graphic techniques.

TAPES
£3.75
each

DISCS
£5.75
each



Plus all the listings from the third issue of Electron User.

JANUARY 1984: Barrels, an all-action arcade game. Noteplay, an entertaining musical utility. Dump1 and Dump2, multitone screen dumps. All the programs from our Sound, Beginners' and Graphics articles Plus 12 programs from the fourth Electron User.

FEBRUARY: Invasion, the classic arcade game. Frogs, fun for all the family. Engvgen, a logic game. Balance, a number learning program. Key, single key entry for the BBC Micro Plus nine other programs from *The Micro User*.

MARCH: Mazemunch, block-busting arcade action. Birthday,

family fun for our anniversary. Derrick, number fun for infants. Pixelpen, high resolution for lightpens.

APRIL: Microgolf, the simulation. Eastermaze and April Fool, seasonal games. Seawall and Magic Square, maths fun. Filer and Album, a database of sounds. TRX1, TRX2, RS243 driver. Heartrate, monitor your fitness.

MAY: Dug Dig, asteroid adventures. Damraider, naval action. Envaud, easy envelopes. Steppers, Body Building motor control. Spiro, graphics windows. Adventure, a trapdoor maze. Renumber, program utility. Bigletter, large type. Memory, RAM efficiency.

JUNE: Roadracer, 3D driving action. Quadline, four-in-a-line

logic game. Monitor, machine code debugging routines. Toolkit, 8271 disc controller explored. Areas, easy maths. Spell, spelling education.

JULY: Doomrun, deep space drama. Backgammon, the classic board game. Keys, user defined key editor. Save? and Tidisk, disc utilities. Alice1 and Alice2, mini-adventures. Terminal1 and Terminal2, two communication programs. Acoustic, software for the Body Build Modem.

AUGUST: Castle, an enthralling adventure program. Gridman, a high speed game of strategy. Tedit, a superb Teletext editor. Dsquare, simple number fun. Dedit, a versatile disc editor. Input, the ultimate general input routine. Bells, Alice's mini-adventure.

SEPTEMBER: Villains, save your crystals from the evil onslaught. Rollerball, an intriguing game of strategy and agility. Microterm, communications terminal software. T/Textidump, high quality Mode 7 screen dump. Numbersign, simple number skills test for infants. Fmeter, four body building programs.

OCTOBER: Wampus, explore the labyrinth and slay the beast. Balloon, brave the caves, escape the Goulogs. Splits, split screen utility. Pageram, paged RAM programs. Input1/2, alternative inputs for the disabled. Morecol, extend the colour palette. D/A, a wave form generator. Integer, direct addressing speed.



Take out a year's subscription NOW!

Make sure you get your copy of *The Micro User* HOT OFF THE PRESS - month after month for the next year.

COMPLETE THIS COUPON TODAY

ORDER FORM

All prices include postage, packing and VAT, and are valid to September 28, 1984

Please enter number required in box

£ p

Micro User

annual subscription

UK £15
 EIRE £15 (IR £18)
 Surface mail - Rest of world £20
 Air mail - Rest of world £65

Commence with issue TOTAL

Micro User back issues

March 1983	£1	<input type="checkbox"/>	Jan 1984	£1	<input type="checkbox"/>
April 1983	£1	<input type="checkbox"/>	Feb 1984	£1	<input type="checkbox"/>
May 1983	£1	<input type="checkbox"/>	Mar 1984	£1	<input type="checkbox"/>
June 1983	£1	<input type="checkbox"/>	Apr 1984	£1	<input type="checkbox"/>
July 1983	£1	<input type="checkbox"/>	May 1984	£1	<input type="checkbox"/>
Aug 1983	£1	<input type="checkbox"/>	June 1984	£1	<input type="checkbox"/>
Sept 1983	£1	<input type="checkbox"/>	July 1984	£1	<input type="checkbox"/>
Oct 1983	£1	<input type="checkbox"/>	Aug 1984	£1.25	<input type="checkbox"/>
Nov 1983	£1	<input type="checkbox"/>	Sept 1984	£1.25	<input type="checkbox"/>
Dec 1983	£1	<input type="checkbox"/>			

Airmail prices on application.

UK Postage 50p per copy (6 or more £2.50)
 Overseas Postage 75p per copy (6 or more £4.50) TOTAL

Annual subscription for tapes and discs*

£40 - Tape
 £60 - Disc

Commence with (state month) TOTAL

Single copies of tapes and discs*

£3.75 - Tape
 £5.75 - Disc

(UK & Overseas)
 *Please indicate which DFS and disc format you require:

- Acorn
- Amcom
- Watford
- 40 track
- 80 track
- Other _____

Deathwatch	Mar 1983	<input type="checkbox"/>
King Kong	Apr 1983	<input type="checkbox"/>
Air Strike	May 1983	<input type="checkbox"/>
Space Pilot	Jun 1983	<input type="checkbox"/>
Tenpin	Jul 1983	<input type="checkbox"/>
Fruities	Aug 1983	<input type="checkbox"/>
Robin & Marian	Sep 1983	<input type="checkbox"/>
Gone Fishin'	Oct 1983	<input type="checkbox"/>
Blackjack / Goblins	Nov 1983	<input type="checkbox"/>
Tower Bridge	Dec 1983	<input type="checkbox"/>
Barrel Battle	Jan 1984	<input type="checkbox"/>
Alien Invasion	Feb 1984	<input type="checkbox"/>
Mazemunch	Mar 1984	<input type="checkbox"/>
Microgolf	Apr 1984	<input type="checkbox"/>
Damraiders	May 1984	<input type="checkbox"/>
Road Racer	Jun 1984	<input type="checkbox"/>
Doomrun/Backgammon	Jul 1984	<input type="checkbox"/>
Castles of Fear	Aug 1984	<input type="checkbox"/>
Villains	Sept 1984	<input type="checkbox"/>
Hunt the Wumpus	Oct 1984	<input type="checkbox"/>

Dust Covers

£3.95 - Deluxe
 (UK & Overseas) TOTAL

Binders

£3.95 - UK
 £5.00 - Overseas
 TOTAL

Payment: please indicate method (✓) TOTAL

- Access/Mastercharge/Eurocard
- Barclaycard/Visa
- American Express
- Cheque/PO made payable to Database Publications Ltd.

Name _____

Address _____

Signed _____

Send to: Micro User, FREEPOST, Europa House, 68 Chester Road, Hazel Grove, Stockport SK7 5NY.

(No stamp needed if posted in UK) Please allow 28 days for delivery

You can also order by phone or Prestel

Any of the goods listed here can be ordered by telephone. Micronet subscribers and other users of Prestel can also use the Prestel Mailbox.

Telephone:
061-480 0171

Prestel Mailbox
 Key Page 77, then send your order to:
614568383
 24 hours

Don't forget to quote your credit card number AND your full address

Keep your copies neat and complete

These handsome binders are bound in PVC with the Micro User logo in gold blocking on the spine.



MicroSac - the tailor-made tote bag for your BBC Micro

Lots of space for all your equipment - sturdy foam-padded design - easy to carry.

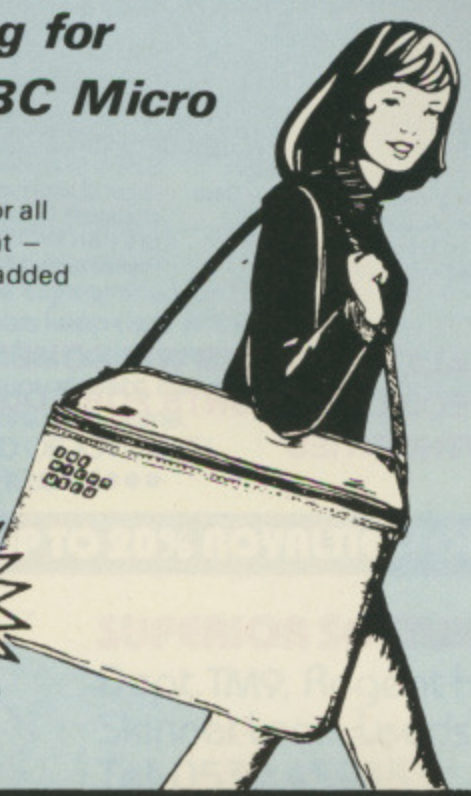

ONLY £19.95 + £1.80 p&p

GRAFPAD

...for as many uses
as YOU
can imagine!

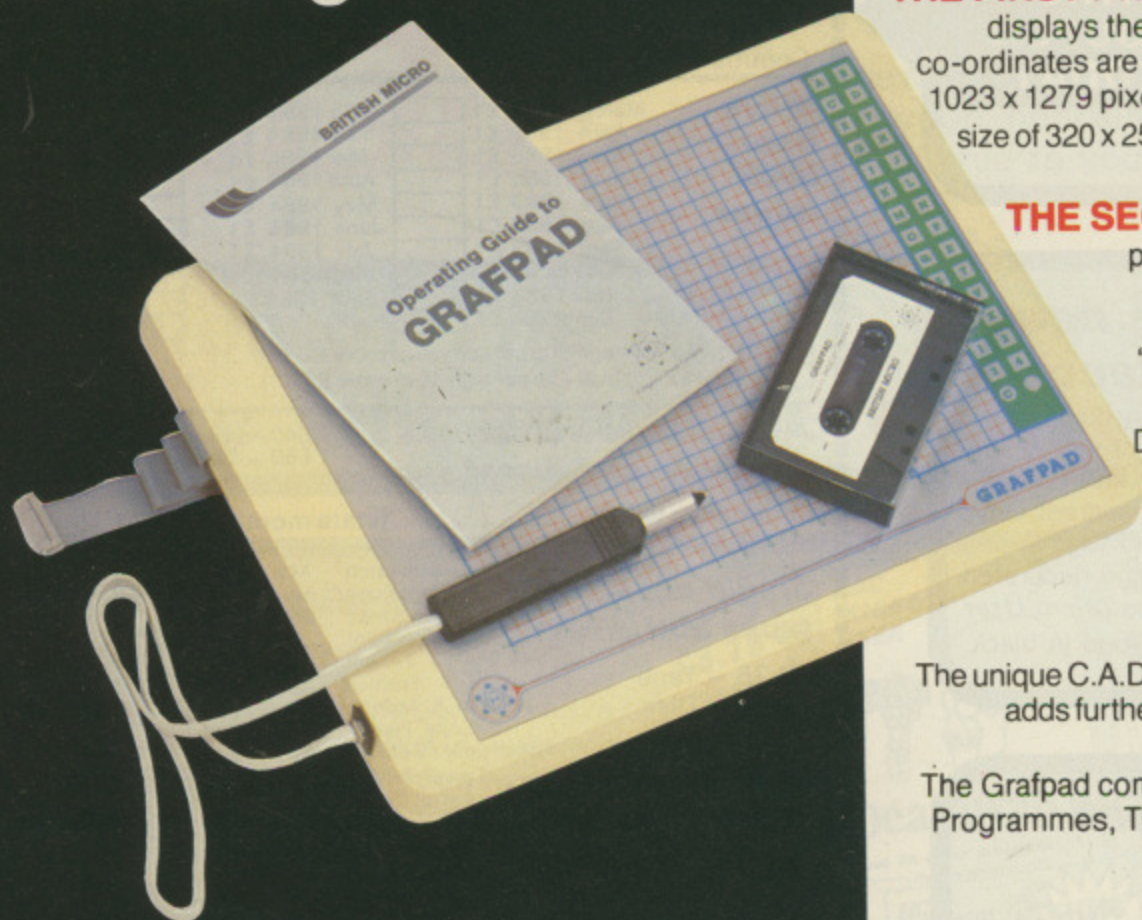

BBC MODEL B • SPECTRUM COMMODORE 64

With Grafpad you can now add a new dimension to your computer enjoyment, but most important, it helps you create your own application programmes by the simple use of the Grafpad!

The BBC Grafpad comes complete with cassette and disk comprising of three programmes.

THE FIRST PROGRAMME

displays the co-ordinates of your screen area. The co-ordinates are based on the screen with a grid size of 1023 x 1279 pixel, also in the Grafpad giving you a grid size of 320 x 256 pixels! This is to allow you to write your own graphic programmes.

THE SECOND PROGRAMME

provides you with the utilities for circles, squares, triangles, free-hand, erasing line-drawing etc, and of course, full "Fill-in" facility in 16 different colours by the simple use of the pen!

Draw from a simple apple to a computer circuit - store in cassette or disk, perhaps transfer direct to a printer - in black and white or full glorious colour!

THE THIRD PROGRAMME

The unique C.A.D. (Computer Aided Designs) programme adds further enjoyment and professionalism to your computer designs!

The Grafpad comes complete with Operational Manual, Programmes, The Grafpad and Pen and it simply plugs in your computer.

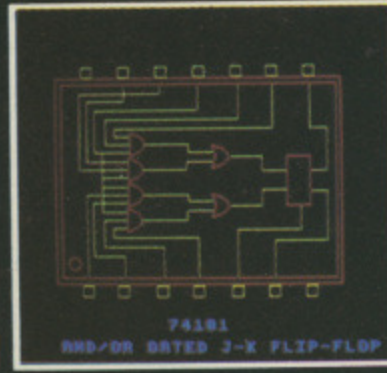
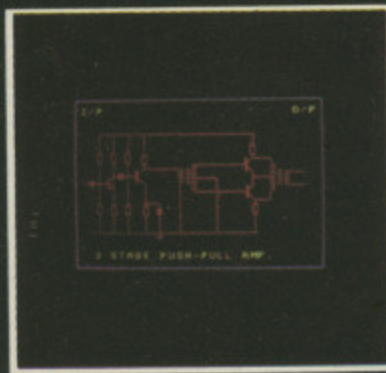
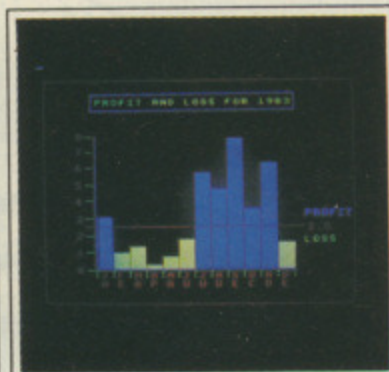
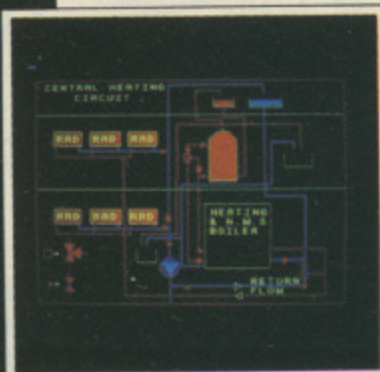
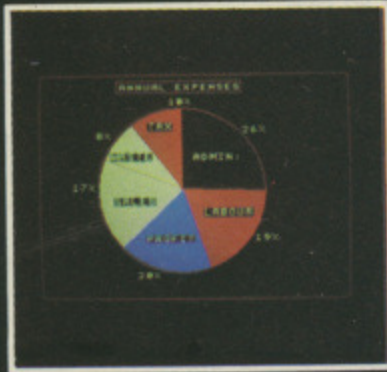

(The above designs were drawn by a 12-year-old at our showrooms!)

(Size: 25mm height x 355mm width x 260mm depth)
Weight: 1.2kg (Gross)

HOW TO ORDER:

BY TELEPHONE:

If you are an Access Card Holder simply telephone us giving your Card No., Name, Address and item(s) required and your orders will be dispatched within 48 hours!

BY POST:

Simply fill in your requirements on a sheet of paper, enclosing your cheque/P.O. made payable to: BRITISH MICRO. Please allow 14 days for delivery.

- DEALER INQUIRIES WELCOMED
- SPECIAL DISCOUNTS FOR EDUCATIONAL AUTHORITIES

BRITISH MICRO

A HEGOTRON GROUP COMPANY

Unit Q2, Penfold Works, Imperial Way, Watford,
HERTS WD2 4YY
TEL: (0923) 48222.
TELEX: 946024



NEW RELEASES

**BBC
MICRO**

SPECIAL OFFER!
Order both directly from us and deduct £1 from each.

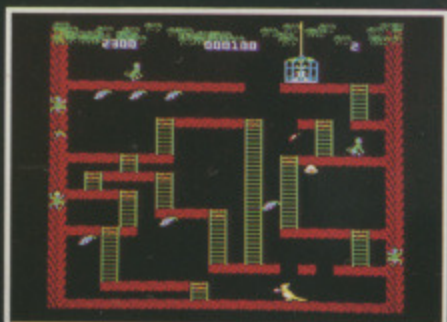
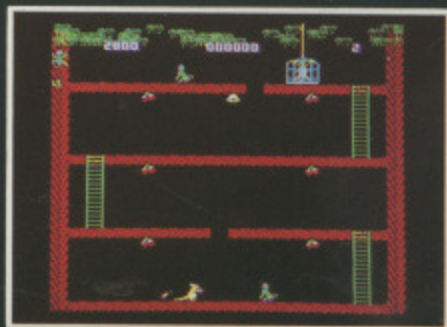
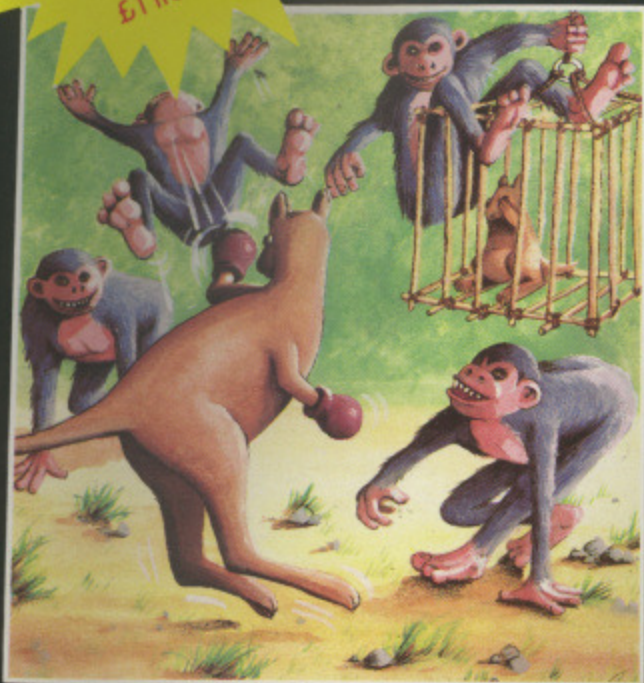

WALLABY (32K)

£7.95

From the author of *Overdrive* comes another superb arcade-action game. You must guide Wally the Boxing Wallaby up the ladders to rescue the baby wallaby from its cage. The evil monkeys will try to stop Wally in his tracks; he can kill the monkeys by a swift upper-cut, but watch out for the apple-cores which they hurl at him without compassion. Five screens of increasing difficulty with bonus fruit on each level. Yet another winner from Superior Software!

●●●NEW RELEASE●●●



Many of our titles are available in Boots, W.H. Smiths, John Menzies, Rumbelows, Laskys, Cumys, HMV, Greens at Debenhams and Spectrum Shops. Also at all major computer dealers – Eltec Computers, Micro Management, West Coast Personal Computers, Microstyle, Electronequip, 3D Computers, Computerama, GTM Computers, etc. Our software is also available through all the major distributors, and directly from us by mail-order.

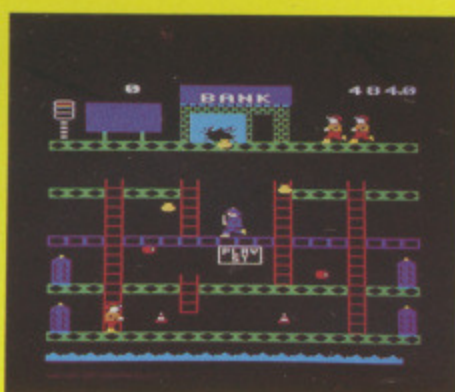
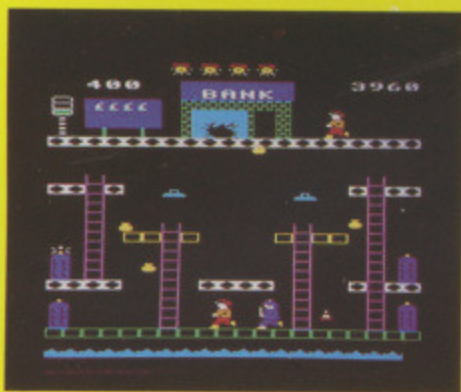

SMASH AND GRAB (32K)

£7.95

An excellent and original arcade-style game in which you take the role of a robber aiming to snatch bags of gold from the bank. A policeman is after you ... he is able to jump at you or squat down and try to hit you with his truncheon. You must also keep clear of the flying police cones and floating dustbin lids. There are 3 fascinating screens of action including play streets with bouncing balls, one-way streets, conveyor belts, traffic lights and police-boxes. A novel and amusing game.
(KEYBOARD OR JOYSTICKS)

●●●NEW RELEASE●●●

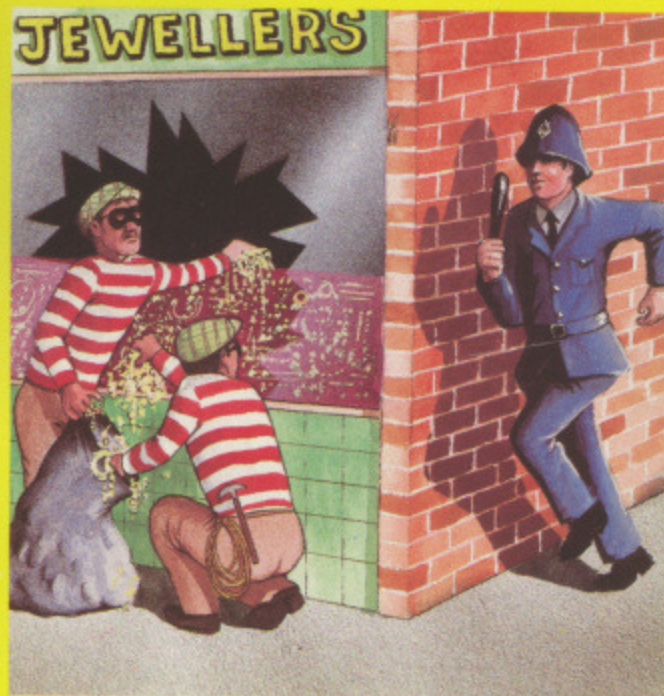

WE PAY UP TO 20% ROYALTIES FOR HIGH QUALITY BBC MICRO AND ELECTRON PROGRAMS.



SUPERIOR SOFTWARE LTD.

Dept. TM9, Regent House,
Skinner Lane, Leeds 7
Tel: 0532 459453

OUR GUARANTEE

- (1) All our software is available before we advertise.
- (2) All our software is despatched within 48 hours by first-class post.
- (3) In the unlikely event that any of our software fails to load, return your cassette to us and we will immediately send a replacement.

M I C R O P O W E R M I C R O P O W E R M I C R O P O W E R M

ANOTHER INCREDIBLE CHALLENGE FROM BRITAIN'S LEADING SOFTWARE HOUSE

FELIX

Meets
The

EVIL SWEEVILS



Clamber up the pipes, dodging the cascading ball bearings to despatch the Weevils and Superweevils using your spray can. Features oxygen cylinders, bonus letters, belt lever and panic button.
NEW PRICE! B.B.C. and Electron cassette: £6.95. B.B.C. disk version: £9.95.

(B.B.C. MICRO VERSION)

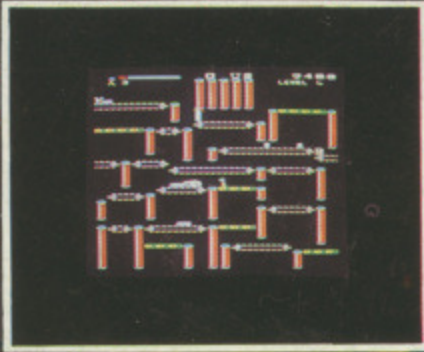

electron
B.B.C. MICRO

M I C R O
P O W E R

MICRO POWER LTD.,
NORTHWOOD HOUSE, NORTH STREET,
LEEDS LS7 2AA TEL: (0532) 458800
MICRO POWER SOFTWARE IS AVAILABLE FROM
SELECTED BRANCHES OF WH SMITH, BOOTS, JOHN
MENZIES, CO-OP, WOOLWORTHS AND ALL GOOD
DEALERS.
AUTHORS! WE PAY 20% ROYALTIES!

"WATCH OUT
FOR THE FANTASTIC
NEW PACKAGING!!"



M I C R O P O W E R M I C R O P O W E R M I C R O P O W E R M

WERMICROPOWERM

THE CHALLENGE FROM BRITAIN'S LEADING SOFTWARE HOUSE

FELIX

Meets
The

SWEETWILLS



**MICRO
POWER**

MICRO POWER LTD.,
NORTHWOOD HOUSE, NORTH STREET,
LEEDS LS7 2AA TEL: (0532) 458800
MICRO POWER SOFTWARE IS AVAILABLE FROM
SELECTED BRANCHES OF WH SMITH, BOOTS, JOHN
MENZIES, CO-OP, WOOLWORTHS AND ALL GOOD
DEALERS
AUTHORS! WE PAY 20% ROYALTIES!

"WATCH OUT
FOR THE FANTASTIC
NEW PACKAGING!!"



THE MICRO USER

Independent
guide to the
BBC MICRO!

THE MICRO USER

Bring split-screen
power to your micro

Two great games:
Hunt the Wampus
Escape the Goulogs

6809 2nd processor,
Addcom reviewed

How to conjure up
extra colours...
write your own
ROM software

October 1984

Vol. 2 No. 8

electron
B.C. MICRO

WERMICROPOWER

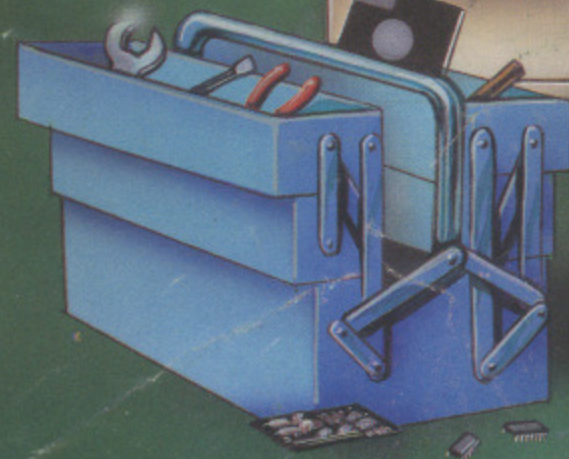

So
To
R
co